



AE300
INTEGRATED VOICE ALARM SYSTEM
EN54-16 EN54-4



OPERATING and INSTALLATION MANUAL





1. INTRODUCTION

The AE300 voice alarm system is a device for signalling in case of fire, designed according to EN Standards 54-16 and 54-4. It is an integrated, monolithic system with a single casing containing the voice alarm system blocks and the power supply unit with backup batteries. The system can play back recorded alarm messages through the monitored contact inputs, or an operator can speak directly through a microphone integrated in the front panel, or from a remote emergency microphone workstation.

The system also has inputs for a service microphone workstation, background music diffusion, contacts for playing back generic messages, as well as an Ethernet port.

Depending on the model, the system has (or does not have) a backup amplifier.

2. SAFETY NOTES AND WARNINGS

- **This device must be installed in accordance with UNI Standard EN54-32:2015 and serviced only by qualified personnel.**
- **This manual must be read and understood before commissioning the device.**
- **This device is set-up for operation using mains voltage within the 230 V +10% -15% range and 48V backup batteries with 7.2A/h capacity.**
- **It is necessary to strictly follow the instructions in Par. 4.p “Connection to the mains power supply and earthing”**
- **The device is protected by fuses on the main power supply (230V) and on the backup power supply (48V battery). The fuses, respectively indicated as F1 and F2, are present on the power supply card. F1=T3.15AH, F2=T8AH**
- **All connections must be made with device off.**
- **The end of a stranded conductor must not be terminated with a soft solder in the points in which the conductor is subjected to a contact pressure (e.g. the header of the wirings which go to the cable seal terminals must not be tin-plated but terminated with a crimping ferrule.)**
- **The installer is responsible for setting up a 6A-C6 circuit breaker (in appropriate electrical panel) dedicated to this device. The circuit breaker must be placed in an easily accessible position. The circuit breaker must bear the words “VOICE ALARM SYSTEM – DO NOT SWITCH-OFF”**
- **In order to avoid the risk of electric shocks, when accessing the inside of the device you must disconnect the power supply network (230V). It is also necessary to disconnect the battery as there is a DANGEROUS ENERGY LEVEL inside the machine (in particular to fastons J6 and J7).**
- **Do not expose the device to humidity or rain or any other liquid. Keep the device away from objects or containers with liquid that could be accidentally poured inside, through the ventilation slots.**
- **Install the device in a cool, ventilated place and away from heat sources.**
- **Install the device so as not to obstruct the ventilation slots.**
- **Connect only batteries with the rated voltage and capacity described in this manual.**
- **Do not reverse the polarity of the batteries.**
- **The batteries must have a casing with flammability class HB or better**
- **When installing the device, be very careful not to damage the electronic card with tools (pliers, screwdrivers, etc...).**



3. MAIN FEATURES, FUNCTIONS WITH REQUIREMENT AND ACCESSORY FUNCTIONS.

- Integrated, single-zone (1 zone max) voice alarm system, with class D power amplifiers and power supply unit with primary source (230Vac network) and backup source (48V batteries).
- ARM Cortex M3 processor, DSP 16bit 48Khz.
- Controlled dynamic microphone on front panel; microphone capsule continuity monitoring, cable cut and short-circuit
- Key or password to access the machine functional levels
- Alarm and generic messages, recorded on uSD card. Contents monitored by system processor.
- Class D power amplifiers, power 300W
- 2 Speaker lines (line A and line B) with 100V constant voltage with transformer coupling
- Independent monitoring of the speaker lines (A+B) with direct measurement of AC voltage and current at 18Khz and FFT analysis.
- 2 Contact inputs with line monitored for alarm message activation (interruption and cable cut)
- 8 contact inputs (not monitored) to activate generic and service messages
- 3 open-collector outputs for reporting the machine status: alarm and fault. The open-collector outputs must only be connected to circuits operating at SELV voltage.
- Input for remote emergency microphone workstation with monitored connection.
- Input for generic microphone workstation for service messages
- RS485 port (reserved for future use)
- Ethernet port for remote communication (reporting of status, configuration, audio streams).
- Power supply unit according to Standard EN54-4 with main source (230Vac); backup source (48Vdc battery); temperature, battery impedance and battery charger status monitoring.
- Comprehensive user interface for a straightforward configuration



The following figure schematically shows the connections outside the system.

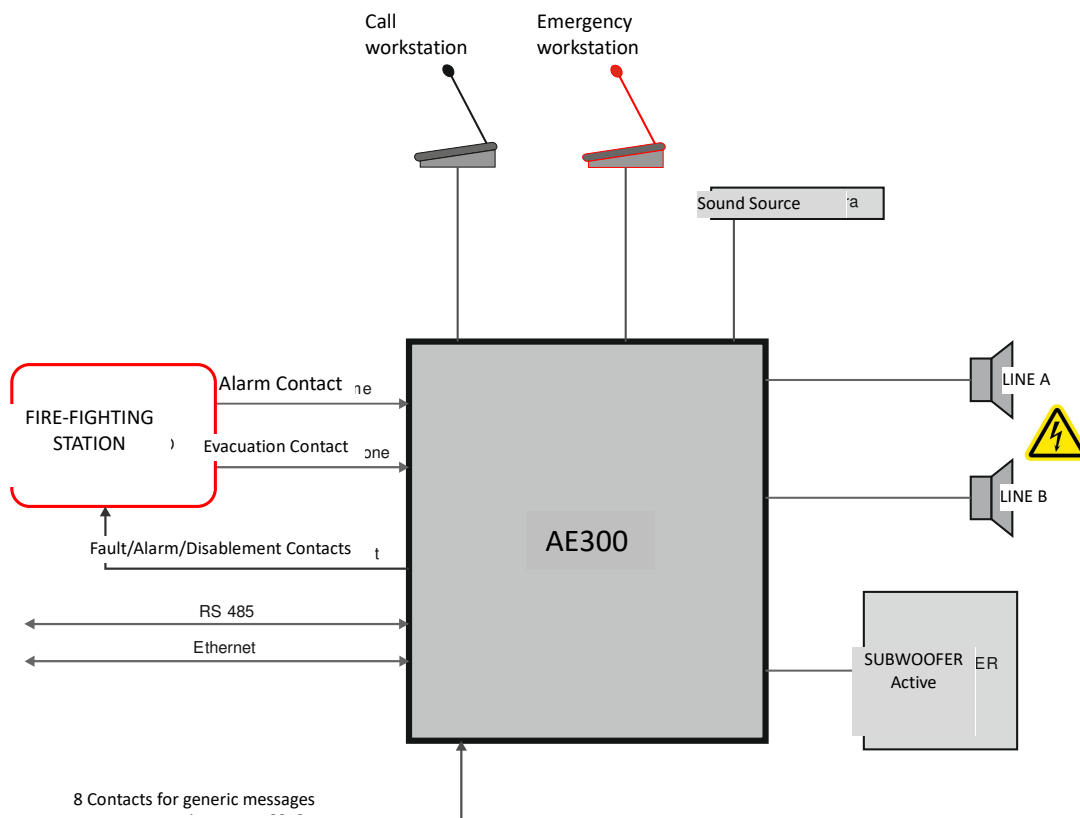

Front panel

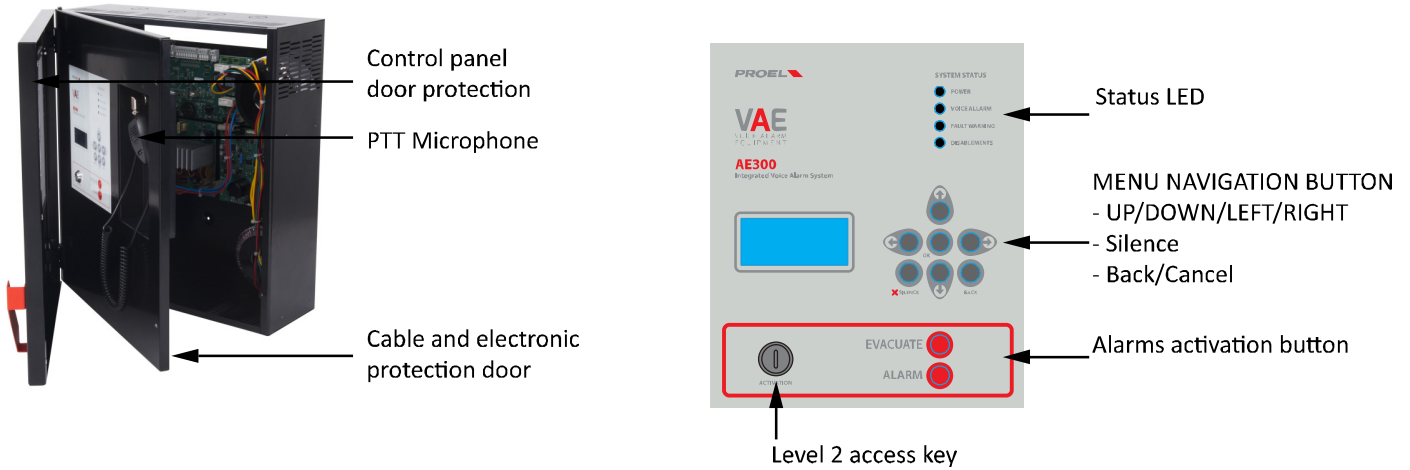

The front panel of the machine has the user interface through which you can manage the system and view its status.

At the top, the LEDs synthetically report the machine statuses:

- **Green LED - POWER:** indicates that the machine is on and operating
- **Red LED – VOICE ALARM:** indicates that a voice alarm or evacuation message is being played back
- **Yellow LED – FAULT WARNING:** indicates that the machine, a loudspeaker line or a connection to the system is faulty
- **Yellow LED – DISABLEMENT :** indicates that the monitoring of one or more machine functions has been deactivated

In the central part, the display shows the details on the machine status and, through the keyboard, you can access the internal menus.

Bottom-right of the user panel, the ALARM and WARNING buttons manually activate alarm or evacuation messages. To activate these alarm messages, or access the machine functions in the menus, you must login at access level 2 with the key (bottom-left) or by entering a password in the appropriate menu.

Finally, there is a PTT microphone on the machine front panel for issuing speakerphone alarm and evacuation messages. To activate the microphone, you must login at access level 2 (with key or password), then press the key on the side of the microphone to speak.

4. INSTALLATION AND MAINTENANCE

The system must be installed by qualified personnel and in accordance with UNI Standard EN54-30.

Unpack the device, loosen the two screws on the right of the front panel and rotate the door on the pins on the left side.

Inside are the machine electronics composed of three or four cards, depending on the model (with or without backup amplifier)

4.a Wall mounting

Fix the device to the wall with wall plugs and screw through the holes on the bottom of the container, indicated in the figure below by arrows:

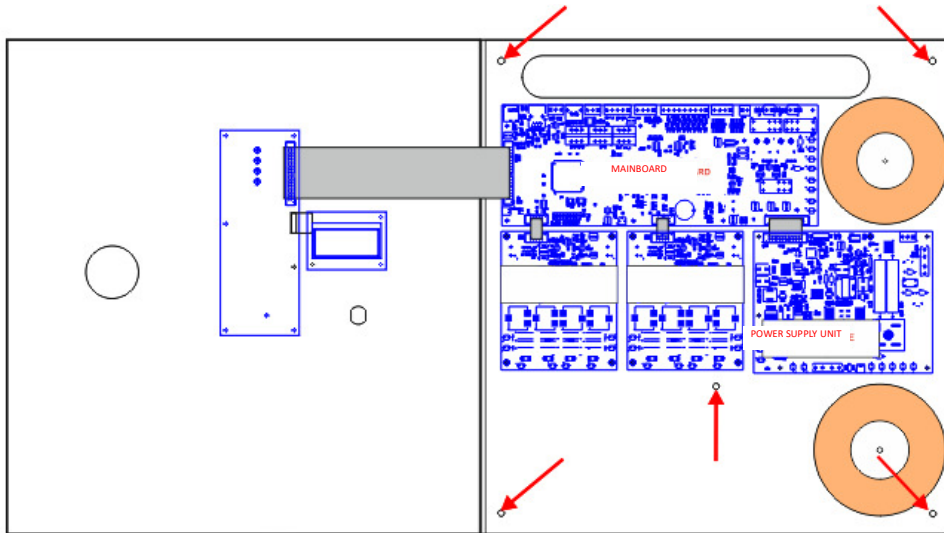

Use suitable type wall plugs according to the characteristics of the wall and with load from 0.30 to 0.65 kN. The device must be fixed to the wall by qualified personnel.

4.b Connection of the speaker lines

The terminals for connection to the speaker lines are located top-right on the main board, just below the fairlead window. Connect the loudspeaker lines to 100V as shown in the figure. The overall load applied to the two lines must not exceed 300W.

When wiring the loudspeaker lines, be very careful not to short-circuit the two poles between them. If the loudspeaker lines are in short-circuit, the system is not able to play back any alarm message, even if the fault is reported on the user interface.

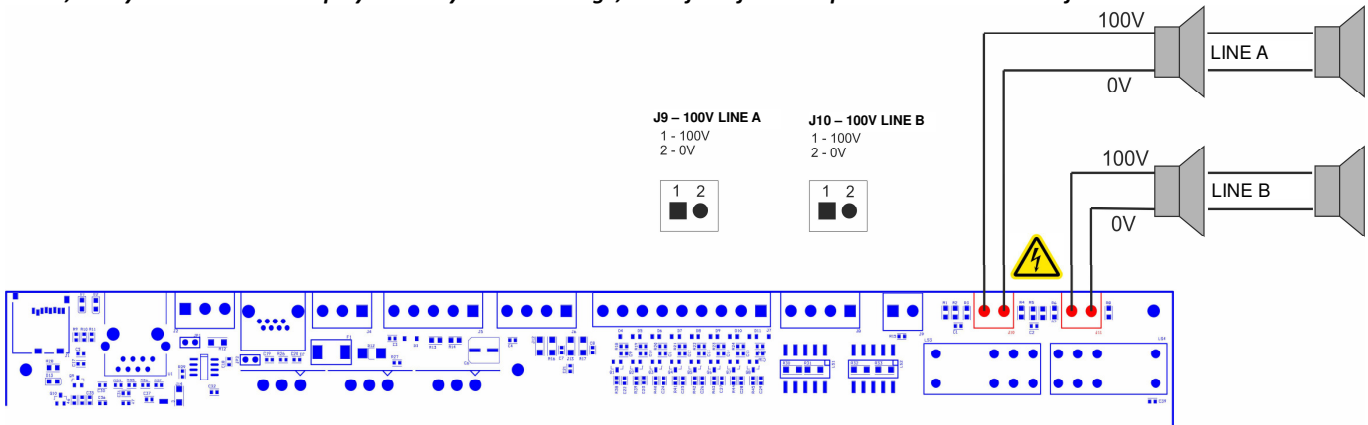

J10 – Line A output	1 – 100V + 2 – 100V -	Output at 100V constant voltage for loudspeaker line A Power levels: 100Vac nom, 300Wrms nom, Rmin=34Ohm Use cable with min section 1.5 mm, max 2.5 mm
J10 – Line B output	1 – 100V + 2 – 100V -	Output at 100V constant voltage for loudspeaker line B Power levels: 100Vac nom, 300Wrms nom, Rmin=34Ohm Use cable with min section 1.5 mm, max 2.5 mm

4.c Subwoofer output

The system has a line output for an active subwoofer.

Connect the active subwoofer to the mainboard terminal shown in the figure. If the subwoofer is not used, leave this output disconnected.

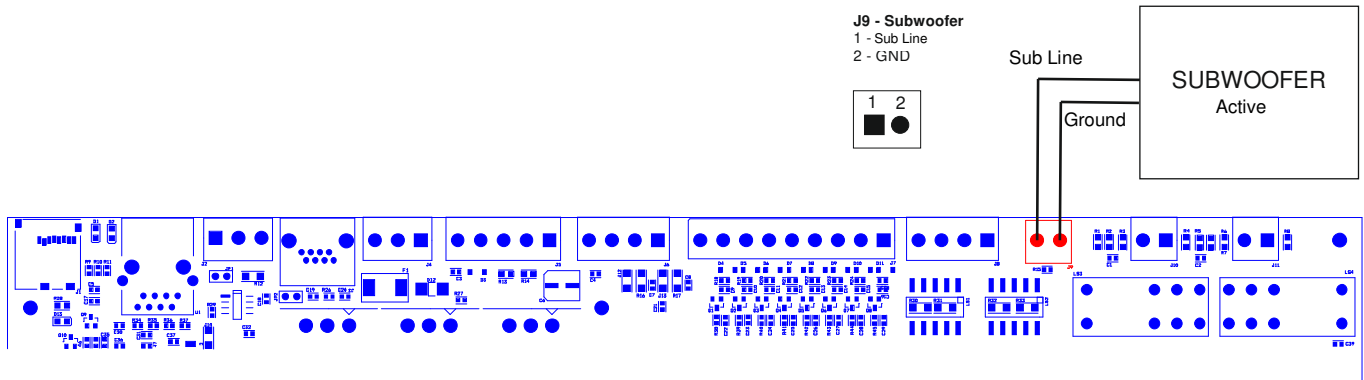

J9 – subwoofer line output	1 – SUB OUT 2 - GND	Line output to active subwoofer with roll-off at 120Hz. The output is only active during playback of the background music applied to input J4 (line input) and is silenced during the voice alarm status. Power levels: 1.0Vrms, Ro=100ohm Use shielded cable with min section 0.5 mm
----------------------------	------------------------	---------------------------------------------------------------------------------------------------------------------------------------------------------------------------------------------------------------------------------------------------------------------------------------------

4.d Status outputs

The system has three status signal outputs. These open collector outputs require a pull-up resistor that can be omitted if the pull-up is already present inside the equipment to which these outputs are connected (e.g. smoke and fire signalling station)

The following figure shows the connection of the outputs to a smoke-fire signalling station with pull-up resistors.

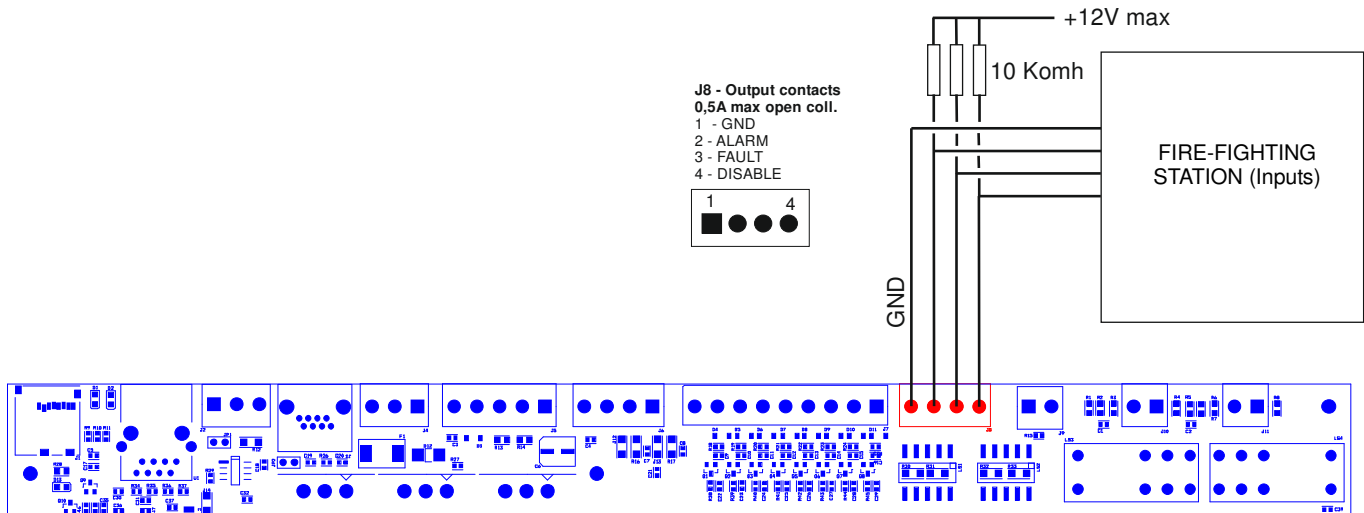

J8 – Open-collector status outputs	1 – GND 2 – ALARM 3 – FAULT 4 – DISABLEMENT	Each output supports up to 0.5A _{dc} and voltage up to 12V Do not directly connect the outputs to direct power supply! Use cable with min section 0.5 mm, max 2.5 mm
------------------------------------	------------------------------------------------------	-------------------------------------------------------------------------------------------------------------------------------------------------------------------------------------

4.e Generic messages activation contacts

The system has 8 unsupervised inputs for activating the generic and service messages recorded on uSD memory card. Each message is activated by closing its ground input, as shown in the figure below.

The playback of the message is activated by a pulse. Releasing the contact after shorting it to ground has no effect, but the message will be played till its end. When a message is being played, a second pulse will stop the player.

Generic messages have predefined priorities: message **n** has a priority over message **n+1**.

Example:

- When message 2 is played, the closing of contact 1 will stop message 2 and start message 1
- When message 2 is played, the closing of contact 2 will stop message 2
- When message 2 is played, the closing of contact 3 is ignored.

This said, message 8 will have the lowest priority, but message 1 has the highest.

Each contact is active only if an associated audio file is stored in the uSD card.

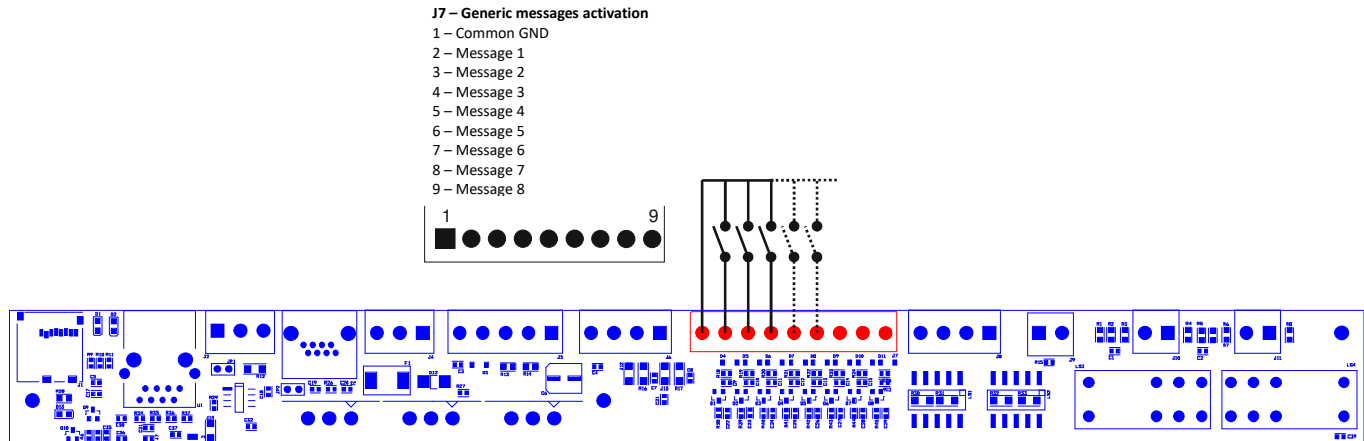

<p>J7 – Unmonitored contact inputs for service messages activation</p>	<p>1 – GND 2 – Message 1 3 – Message 2 4 – Message 3 5 – Message 4 6 – Message 5 7 – Message 6 8 – Message 7 9 – Message 8</p>	<p>Each input is active for closure to ground, protected up to +42V compared to GND Use cable with min section 0.5 mm, max 2.5 mm</p>
------------------------------------------------------------------------	----------------------------------------------------------------------------------------------------------------------------------------------------------------------------------------------------------------------------------------	----------------------------------------------------------------------------------------------------------------------------------------------------



4.f Alarm messages activation monitored contacts

The system has two monitored dry contact inputs to trigger the EVACUATE and ALARM (alert) messages that are stored in the uSD card. The connection foresees two resistors as described in the figure below. configuration of these inputs is described in the dedicated menu. As a factory default, both inputs will trigger their respective message at the opening of the contact and the playback will continue cyclically as long as the input is open. Playback will stop at the closing of the contact.

These inputs, that are typically activated by the fire alarm control panel are monitored against short circuit and cable cut: in this case, the system will trigger a fault warning.

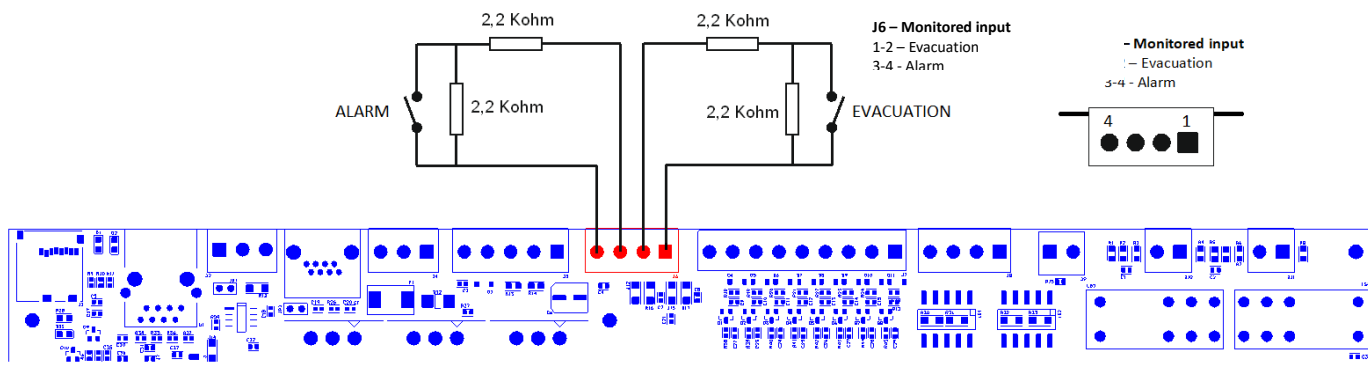

J6 – Alarm messages activation monitored contact input	EVACUATION	Connect the resistors (supplied in the accessory bag) on each pair of contacts as shown in the figure. The resistors must be placed at the end of the cable, from the smoke and fire signalling station side. Refer to the CONF ALARM INPUT MODE menu for the properties and configuration of the input contacts. The inputs of the alarm messages are, by default, configured for normally closed contacts. Use cable with min section 0.5 mm, max 2.5 mm
	1 – CONT 1 P 2 – CONT 1 N	
	ALARM	
	3 – CONT 2 P 4 – CONT 2 N	

If you do not intend to use the remote activation of messages, you cannot leave these terminals open without the device reporting a fault. Therefore, connect two resistors directly on the mainboard terminal so that the device does not signal a connection fault.

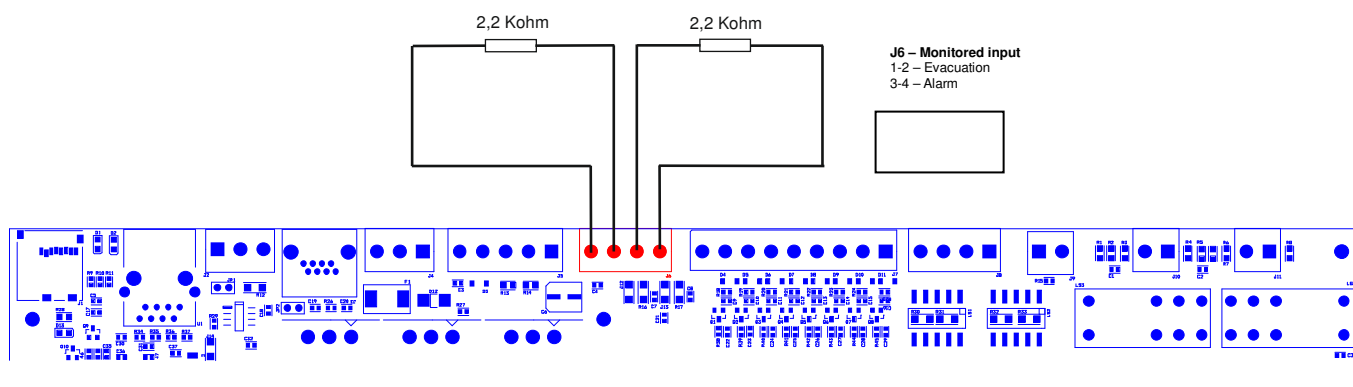

4.g Generic announcement microphone workstation

The system has an input for a microphone workstation for generic announcements, that is not evacuation and voice alarm announcements. The terminal shown in the figure has a balanced microphone input and a priority contact input.

The microphone input for generic announcements also has +48V phantom power supply that can be activated from the menu.

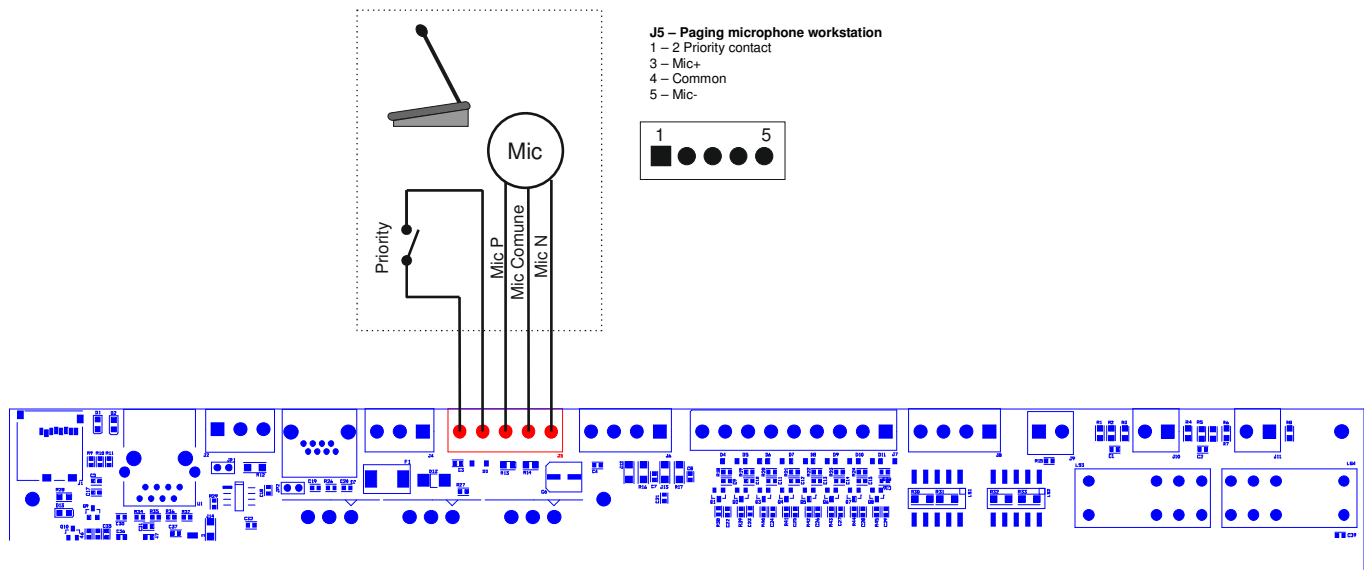

<p>J5 – Mic paging input</p>	<p>1 – GND contact 2 – Priority 3 – MIC P 4 – MIC GND 5 – MIC N</p>	<p>Input for microphone paging workstation for generic announcements. 48V Phantom power supply that can be activated from menu: common mode on pin 1 and 3 compared to pin 2.</p> <p>Power levels: 1.0Vrms max, Ri=600Ohm</p> <p>Active contact for closure to ground, protected up to +42V compared to GND</p> <p>Use cable with 0.5 mm min and 2.5 mm max section on priority contact.</p> <p>Use shielded cable with 0.5 mm min section on audio input.</p>
------------------------------	---------------------------------------------------------------------------------------------------------------------------------------------------------	----------------------------------------------------------------------------------------------------------------------------------------------------------------------------------------------------------------------------------------------------------------------------------------------------------------------------------------------------------------------------------------------------------------------------------------------------------------



4.h Music/line input

The system has a line input for connection to an audio source for background music diffusion.

You can connect both sources with balanced output and sources with unbalanced output. The following figures describe the connections.

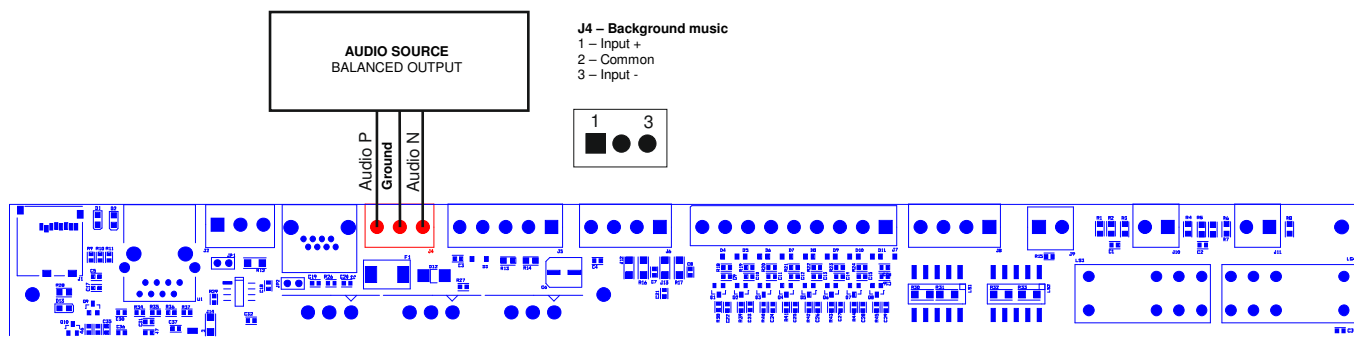

For the connection of audio sources with unbalanced output, connect the positive to terminal 1, the source ground to terminal three and leave the central terminal free.

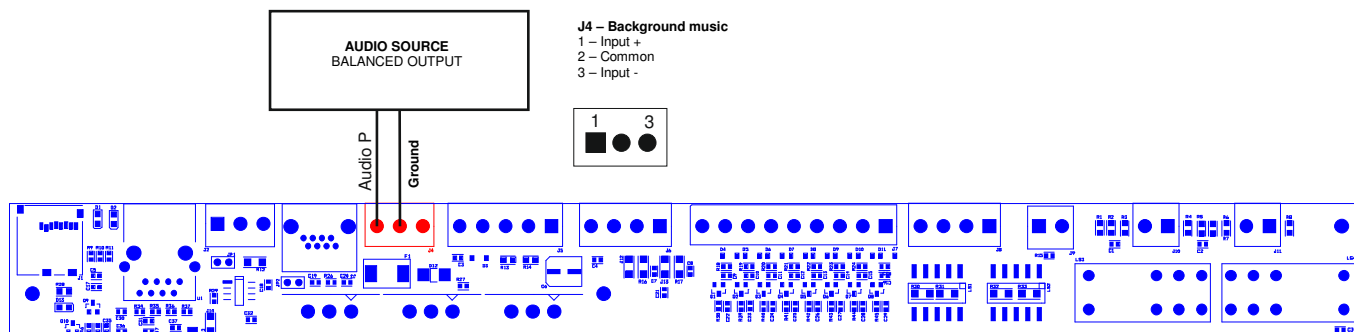

J4 – Line input for audio sources	1 – Audio P 2 – Common/Ground 3 – Audio N	Balanced line input, transformer insulated. Used for background music diffusion. Power levels: 0.8Vrms @ 0dB, Ri=100Kohm Use shielded cable with min section 0.5 mm
-----------------------------------	-------------------------------------------------	---------------------------------------------------------------------------------------------------------------------------------------------------------------------------

4.h Emergency microphone workstation

The system has a RJ45 input for connection to remote emergency microphone workstations and monitored according to Standard EN54-16.

Connect the microphone workstation to socket rJ45 through a UTP CAT5 cable. The connection between the two RJ45 pins to the cable end must be 1-to-1.

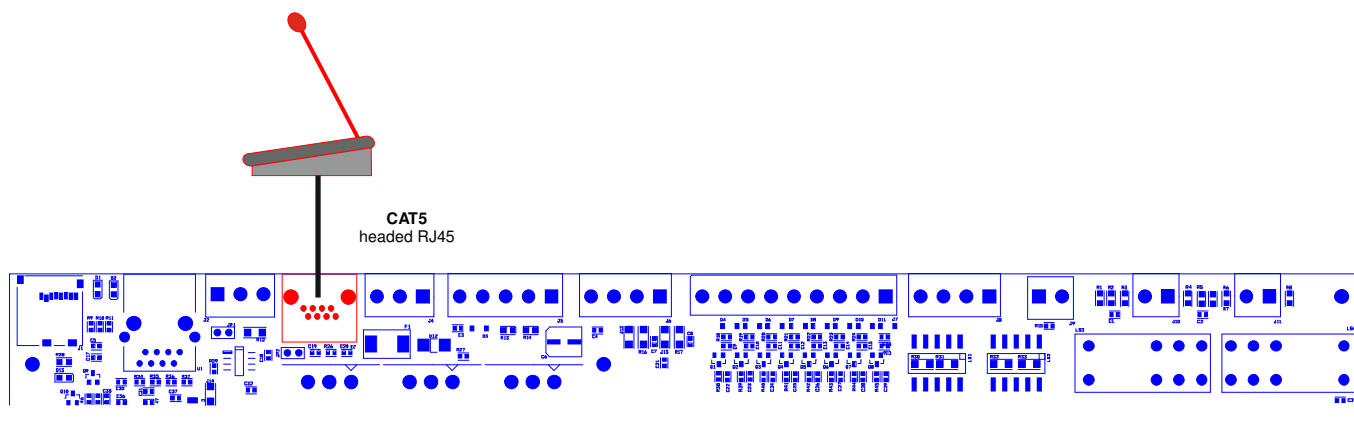



J3 – External emergency mic workstation port	1 – Audio P 2 – Audio Gnd 3 – Audio N 4 – GND 5 – +24Vdc 6 – GND 7 – COMM P C – COMM N	RJ45 Connector for connection to external emergency microphone workstation. This connector carries both the audio signals and data link from and to the external microphone workstation. Connection is monitored and the system reports a fault in case the communication with the microphone workstation is lost due to short-circuit or cable cutting. Proprietary connection for connection to the dedicated microphone workstations only Use 8-pole UTP CAT5 cable, 4 pairs. Head the RJ45 connectors 1-to-1
-----------------------------------------------------	-------------------------------------------------------------------------------------------------------------	------------------------------------------------------------------------------------------------------------------------------------------------------------------------------------------------------------------------------------------------------------------------------------------------------------------------------------------------------------------------------------------------------------------------------------------------------------------------------------------------------------------------

4.i RS485 Serial connection

The system implements an RS485 communication port for connection to remote devices with dialogue through protocol, described in the specific manual. The following figure describes the connection between the AE300 and an external device, through RS485 port. The jumper to terminate the line is located behind the terminal. With the jumper inserted, the line is terminated. With the jumper not inserted, the line is not terminated.

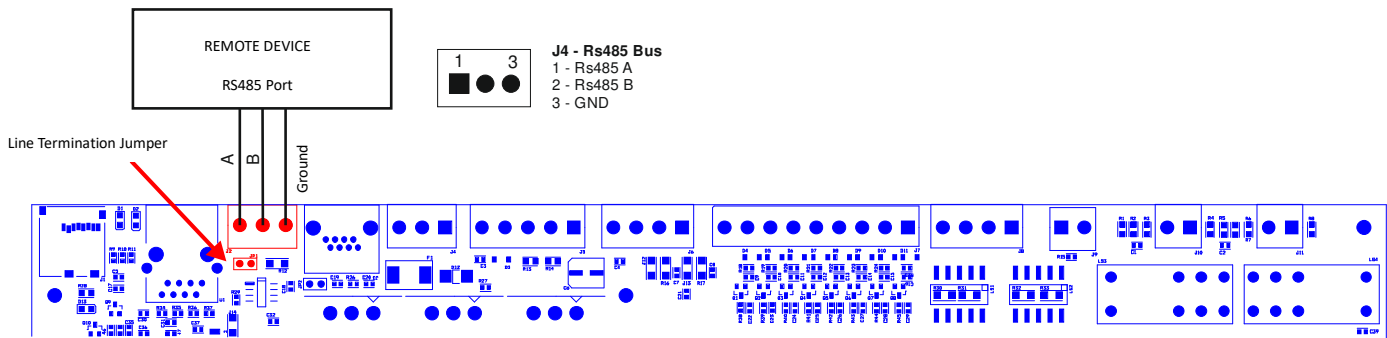

J2 – RS485	1 – RS485 A 2 – RS485 B 3 - Ground	Port RS485 not insulated. Standard power levels ANSI TIA/EIA-485 Use shielded cable with min section 0.5 mm
-------------------	------------------------------------------	-------------------------------------------------------------------------------------------------------------------

4.I Ethernet port

The ethernet port allows connecting the system to a company data network, or a dedicated data network, to remotely monitor the machine and connect several machines in a hierarchical manner.

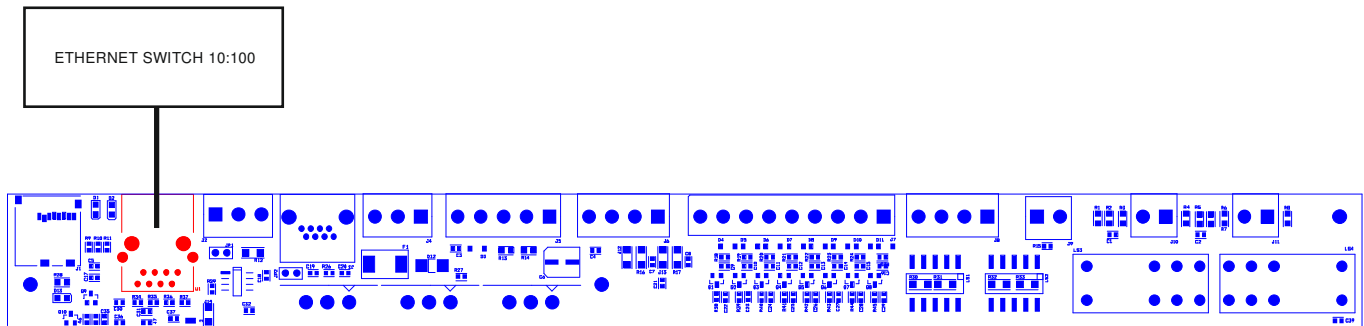

Ethernet port	Standard pinout	Ethernet port 10/100 Base T insulated with coupling to connector built-in transformers Use UTP CAT5 cable
----------------------	-----------------	--------------------------------------------------------------------------------------------------------------



4.m Emergency microphone installation

The device is equipped with microphone for emergency announcements, located on the front panel of the device.

This microphone is monitored against faults (cable cutting, short-circuit and interruption of the microphone capsule)

Take the PTT microphone from the accessory bag, identify the round connector on the front panel. This connector is equipped with a key which determines the direction of insertion (see photo below)



Insert the microphone connector and secure it to the machine body with the appropriate ring nut, then place the microphone on the appropriate hook.

N.B. The device does not operate without the presence of the emergency microphone. If the emergency microphone is missing, the relevant fault is signalled on the user interface.

4.n uSD memory card

The housing for the uSD memory card containing the recorded messages is located on the left side of the mainboard. Before extracting or inserting the card, activate the appropriate DISABLEMENT function of the uSD from the menu.

The port-card connector is of a push-push type: to extract the card, push the uSD fully into the connector until you hear a “click”, then release and extract the card.

Insert the card with the contacts facing down and push until you hear a “click.”

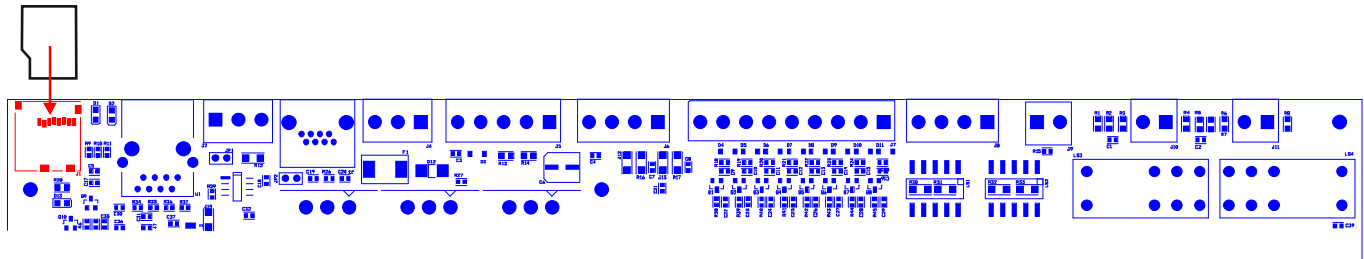

4.0 Installing and connecting batteries

The system provides the use of 4 12V 7.2A/h batteries connected in series to achieve rated 48V. Install the batteries in the bottom space, on the bottom of the container left of the toroidal transformer.

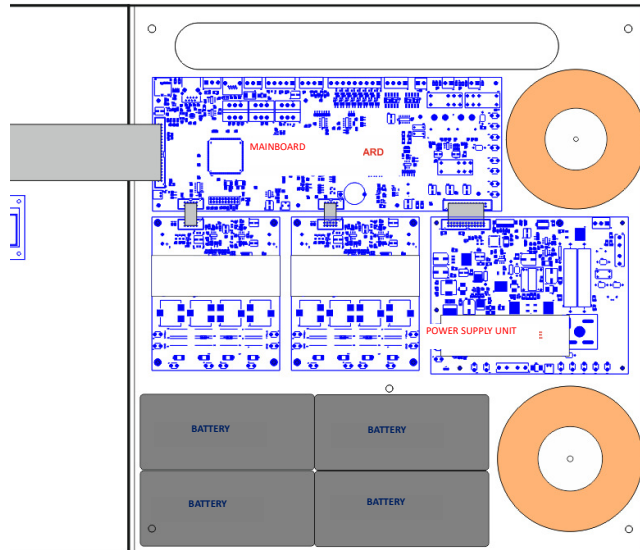

The following figure shows the battery connection to the electronic card of the power supply unit.

The power supply unit card is located bottom-right, between the two toroidal transformers.

The faston terminals + and - 48V are on the bottom of the card.

Connect the four batteries in SERIES (+ on -) with the faston-faston jumpers in the accessory bag.

Connect the negative terminal of the battery pack to faston – on the power supply unit card.

Take the anti-spark cable from the accessory bag and make sure that the two connectors are NOT engaged; the connection between the batteries and the card must take place with this connector OPEN.

Connect one end to the battery positive terminal and the other to the +48V terminal on the power supply unit card.

Close the connector only after connecting the cable to the batteries and the card.

When closing the connector the machine remains in stand-by and does not turn on.

A two-pole white connector identified with "BATT TEMP PROBE" is located to the right of the fuse-holder. Engage the temperature probe in the connector and apply it to one of the batteries using adhesive tape.

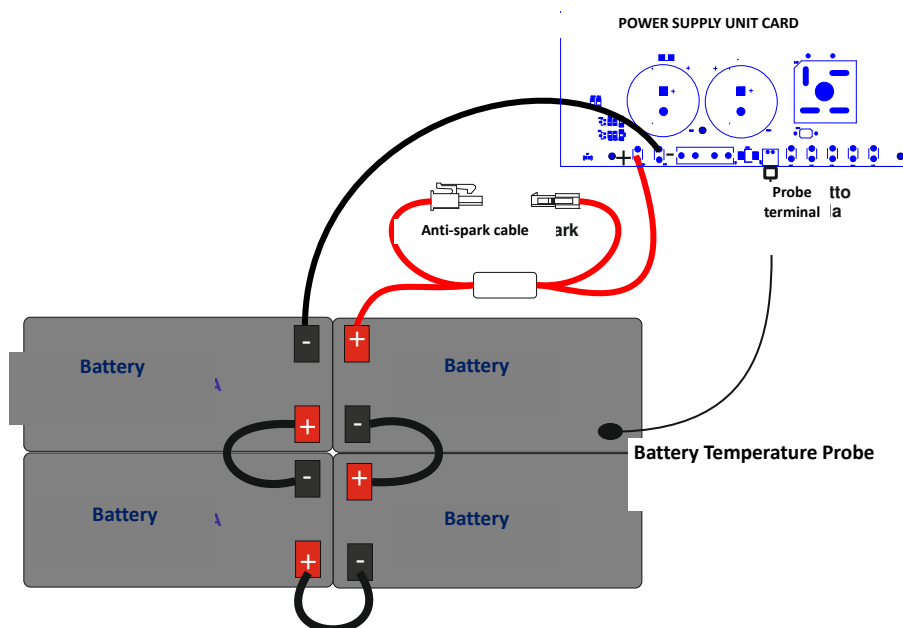



4.p Connection to the mains power supply and earthing

The terminal for the 230V mains power supply and earthing connection is located top-right, near the breakaway slot for cable inlet. The Figure here below shows the LINE, EARTH and NEUTRAL connections.

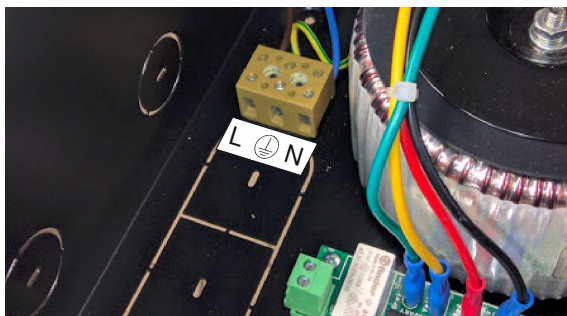

ATTENTION: Make the mains and earthing connections as shown in the above figure.

For the connection to the power mains, provide a 6A-C6 circuit breaker dedicated to the equipment; this must be placed in an easily accessible position.

Use cables with a section of 1.5 mm for both the mains power supply and earthing.

Make sure that the signal cables, and the low voltage cables in general, do not accidentally touch the mains voltage points. These are the terminals for connection to the mains voltage, and the areas marked with the symbol inside the device



4.q Powering the system

After making and checking all connections, close the jumper on the anti-spark cable connecting the battery positive to the power supply unit card (see 4.n), then activate the circuit breaker.

The system display indicates “POWER ON” and so begins the switch-on sequence.

4.r Monitor loudspeaker volume

The trimmer for adjusting the monitor loudspeaker volume on the front panel of the device is located on the bottom of the mainboard (indicated by the arrow in the figure). Enable the playback of any message (see specific menu), then rotate the trimmer to obtain the desired volume.

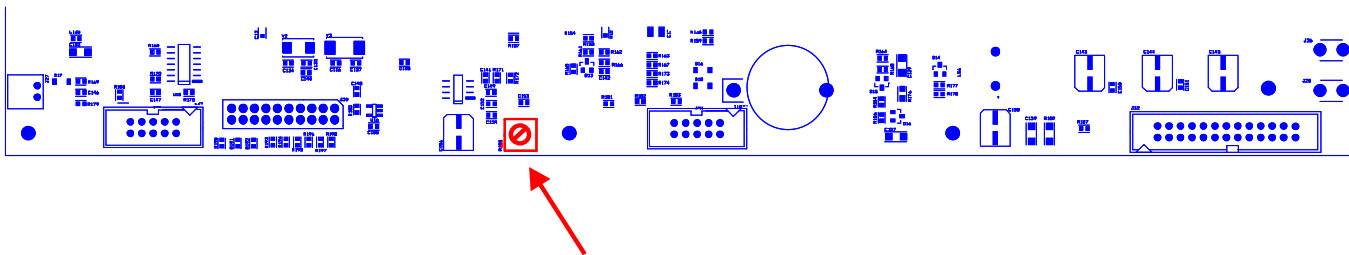

4.s Clock battery replacement

The battery-holder for the buffer battery of the internal clock and calendar is located on the bottom of the mainboard. Although these batteries have a very long life, we recommend replacing them every 24 months.

To avoid having to reset date and time, you can replace the battery with the system on and powered.

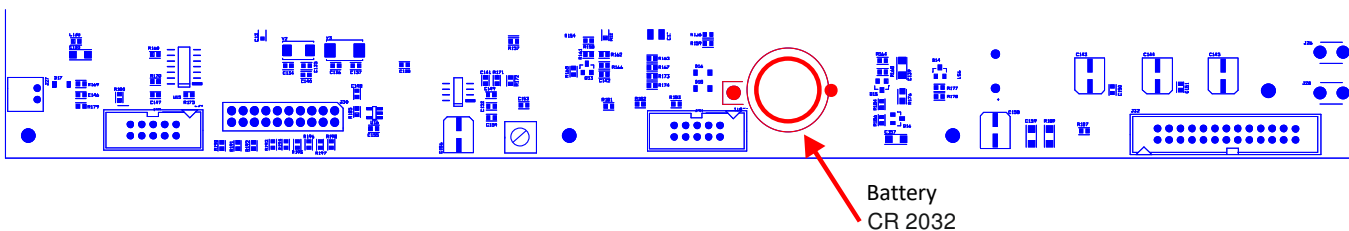



4.t Device maintenance

- a) Periodically clean the device with a dry cloth
- b) Periodically check that the ventilation openings are not obstructed
- c) Periodically check the wiring and connections
- d) Periodically check the efficiency of the earthing connection
- e) Replace the Pb-Gel batteries every 4 years with units having the same voltage and capacity
- f) Replace the CR2032 battery of the internal clock (see par. 4q) every 4 years



5. MENU DESCRIPTION

6.1 Status Description

The system is designed to manage different operating conditions which, according to Standard EN54, are identified in four statuses. The system status is displayed by the LEDs on the front panel of the system and of the remote emergency microphone workstations.

	<p>QUIET Status: Operating condition “at rest”, without faults, no playback of voice alarms and no active “disablements.” Only the diffusion of background music or generic messages (not alarm ones) is allowed. When the system is in the quiet status only the green LED is lit on the front panel of the unit, to indicate that the system is powered.</p>
	<p>ALARM Status (VOICE ALARM): Operating condition where a pre-recorded or speakerphone voice alarm is being issued from the emergency microphone workstation. It can be activated via an external device connected to one of the supervised contacts, or from an emergency microphone workstation. While a voice alarm is issued, the system turns on the red LED to indicate the voice alarm status. The green LED remains on to indicate that the system is powered. The display will show a POP-UP window indicating the source of the voice alarm in progress.</p>
	<p>FAULT Status (FAULT WARNING): Operating condition indicating the presence of at least one fault detected by the internal diagnostic system. The status indication is accompanied by a fault intermittent acoustic signal (buzzer) and the yellow LED lighting up on the unit panel. The green LED remains on to indicate that the system is powered. The display will show a POP-UP window indicating the number of detected faults and a brief description.</p>
	<p>DISABLEMENTS Status: Operating condition in which the functions of one or more system sections are disabled. Even the faults related to the disabled section are suspended since safety functions are deactivated. This condition allows operating on the system without turning it off and without the fault condition (FAULT WARNINGS) being activated. The display will show a POP-UP window indicating the number of active “disablements” and a brief description of the section(s).</p>

NOTE: Operating conditions may also occur simultaneously. The LEDs corresponding to the active conditions will light up on the front panel and the display will show a POP-UP window indicating which and how many events are active. If the number of events exceeds the number of rows of the POP-UP window, indications will cyclically scroll on the display. In this case you can view entries using the UP and DOWN arrows.

6.2 Main Screen

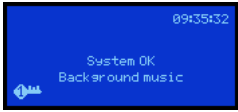

In the absence of warnings, the main screen shows the following information:

- System time: shows the current system time; for the system events to be properly recorded, this should be always updated. It is also important to verify that seconds are regularly counted, otherwise the system CPU may be locked.
- Current access level: A key indicates the current access level 1, 2 or 3.
- System status: The "System OK" text indicates that the system is operating.

In case of a fault, a POP-UP window will appear indicating the number of active faults, the presence and number of "disablements" and if an alarm message is in progress.

Icons

	Current access level: a key positioned bottom-left of the display indicates the current access level: 1, 2 or 3.
	Message playback with active repeat rules. In case alarm or evacuation messages are played back, an icon with two alternate arrows may appear to indicate the presence of rules in the number of repetitions of the current message. The rules impose a minimum number of reproductions and/or a maximum number of reproduction cycles.
	Fault of one of the two lines A or B with volume increase. In case of line fault with redundant A&B line, an icon will appear to indicate that the "non-faulty" line is working with an indicated volume increase.
	Mute on. With mute on, an icon with the loudspeaker crossed is displayed to indicate that the mute is active. During the playback of a pre-recorded or voice message you can activate the "MUTE" function by pressing the appropriate button on the front panel; when on, an icon with a crossed loudspeaker appears on the display. To deactivate, simply press the appropriate button again and mute will be removed. NOTE: as per EN54-16, when "Mute" is activated during the playback of a pre-recorded message, the output is muted only at the end of the message itself to avoid compromising its intelligibility. Likewise, when mute is removed, the message will be played back at the end of the reproduction cycle. Mute activation while an emergency microphone is "speaking" is immediately effective.
	Warning on In case of a system event, a flashing triangle appears to attract the user's attention. The warning is removed when you access the "System Logs" system event menu, which lists the system events.



6.3 Menu Description And Navigation

Using the keyboard on the front panel

	<p>From the home screen where the display shows the general status, press OK to access the menu structure.</p> <p>The OK key in the sub-menus is used to confirm the selection of the element pointed by the navigation arrow.</p>
	<p>Use the UP and DOWN keys to scroll the list of menus and sub-menus.</p> <p>Press OK to access the menu or sub-menu pointed by the navigation arrow.</p>
	<p>Press BACK to go back to the previous menu or cancel the selection of a function. Repeatedly pressing the BACK key from any workstation returns to the main screen.</p>
	<p>Alternatively, you can access the selected menu or sub-menu by pressing the RIGHT key, and go back to the previous menu or sub-menu by pressing the LEFT key.</p>

The main menu is structured in the form of a list in which the functional parts of the system are managed:

Menu tree

- **Line & Amplifiers** Management of Diffuser lines and amplifiers
- **Power supply & Battery** Management of primary power supply (220V) and secondary (Battery)
- **Fire microphone** Management of the emergency microphone workstations
- **Recorded messages & SD** Management of pre-recorded messages on micro-SD card
- **Input contacts** Management of contacts to launch messages
- **Ethernet** Management of ethernet connection
- **System status & Conf** System configuration
- **Volumes** Volumes configuration
- **Message Scheduler** Configuration of hourly programming of pre-recorded messages
- **System Logs** Display of system events
- **Access level login** User authentication

LINE & AMPLIFIERS Menu

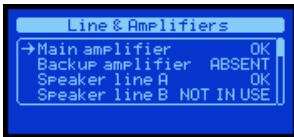

The *Line & Amplifiers* menu allows you to view and manage the status of amplifiers and speaker lines. They appear in the form of a list and can be scrolled using the UP and DOWN arrows. Each amplifier and speaker line is linked to the summary status:

Status of the amplifiers:

DISABLED	→ Disabled (<i>Disablement</i>)
ABSENT	→ Not installed
FAULT	→ Faulty
WARNING	→ Pre-alarm condition
OK	→ Running

Status of the lines:

DISABLED	→ Disabled (<i>Disablement</i>)
NOT IN USE	→ Not in use
NO CALIB	→ Impedance not calibrated
FAULT	→ Faulty
OK	→ Running

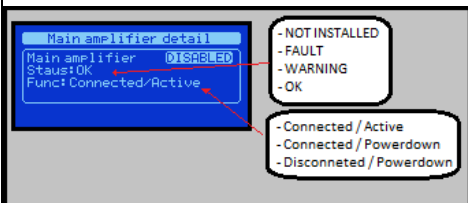

The system works with a *Main amplifier* and a possible *Backup amplifier*. Both the main amplifier and the backup amplifier, if installed, are monitored to ensure effectiveness; in case of a faulty main amplifier, the backup amplifier automatically takes over, if installed.

For details of the status of the amplifiers you can select from the list and press OK to access the *Main amplifier detail* / *Backup amplifier detail* screen that indicates the status in detail. In particular, the display shows the type of amplifier selected and its operating status:

Func: Connected / Active → Connected to the load and active
 Connected / Powerdown → Connected to the load and in energy saving mode
 Disconnected / Powerdown → Disconnected from the load and in energy saving mode

The system works with a single line of speakers that can be managed in single or double mode, also called A&B mode. The content diffused via speakers is unique in both single-line and double-line mode, A&B line. The difference between the two modes is the possibility, in A&B mode, to manage a fault on the speaker line and recover the lost sound pressure by transferring power on the line that is still operating. In the event of a fault, e.g. short-circuit, of the single-mode speaker line (not A&B), the system isolates the line to avoid damaging the amplifier, making it impossible to diffuse any contents. On the contrary, if the line of speakers was wired in double mode, alternating a line A speaker with a line B speaker and homogeneously distributing the speakers on the surface to be sonorised; in the event of a fault on one of the two lines, e.g. short-circuit, the system isolates the faulty line and increase the volume of the remaining line so as to recover the lost sound pressure.

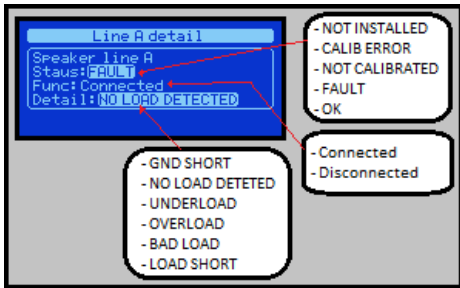

For details of the status of the lines, you can select from the list and press OK to access the *Line A detail* / *Line B detail* screen that indicates the status in detail. In particular, the display shows the status, operation and possible error for the selected line of speakers.

The following errors can be managed:

Detail:	GND SHORT	→ Earthed speaker line
	NO LOAD DETECTED	→ Speaker line interrupted
	UNDERLOAD	→ Loss of line load
	OVERLOAD	→ Increase of line load
	BAD LOAD	→ Line impedance not manageable
	LOAD SHORT	→ Line in short-circuit

The speaker line can be connected or disconnected:

Func:	Connected	→ Speaker line connected
	Disconnected	→ Speaker line disconnected

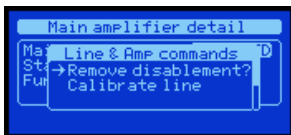

To access the POP-UP where to insert or remove the “disablement” condition, you must have access level 2, otherwise a screen is displayed where you are required to login to carry out this operation.

From the POP-UP, with the section in “disablement” you can calibrate the line impedance by selecting the “Calibrate line” command; execution is immediate and the outcome is shown on the status detail screens of the line of speakers. This operation measures the line impedance at 18KHz to continuously evaluate any changes denoting a change in load.

NOTE: When the “Line & Amp” section is in “disablement,” all safety functions related to the amplifiers and speaker lines are deactivated. Any “FAULTS” are also removed. The “disablement” function allows working on the speaker lines without interrupting the system operation and without generating “FAULTS.”

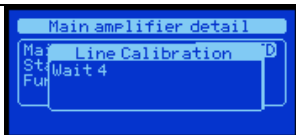

When the line calibration command is selected, the screen changes and a counter appears indicating the time to wait for the procedure to be performed, at the end of which a screen summarising the outcome appears.

Listed below is the status of the two amplifiers and of the two lines managed by the system

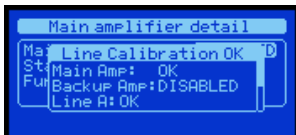

- Main Amp: → Primary amplifier
- Backup Amp: → Backup amplifier

Status of the amplifiers:

ABSENT	→ Not installed
FAULT	→ Faulty
OVERTEMP	→ Condition of overheating
OK	→ Running

- Line A: → Speaker line A
- Line B: → Speaker line B

Speaker line status:

DISABLED	→ Not in use
GND SHORT	→ Earthed speaker line
NO LOAD DETECTED	→ Speaker line interrupted
UNDERLOAD	→ Loss of line load
OVERLOAD	→ Increase of line load
BAD LOAD	→ Line impedance not manageable
LOAD SHORT	→ Line in short-circuit

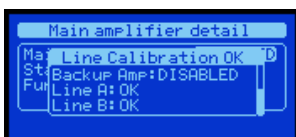

POWER MANAGEMENT Menu

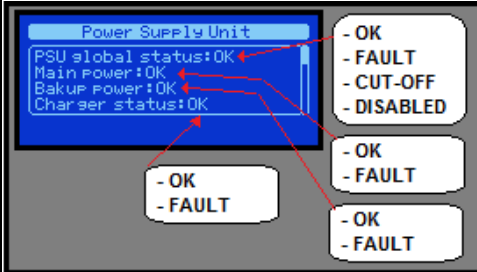

The *Power supply unit* menu allows you to view and manage the status of the system power supply unit. All information is shown in 4 screens selectable with the UP and DOWN arrows, the first of which summarises the status of the macros composing the power supply section:

PSU global status → System power supply unit, consisting of all its components:

- DISABLED → "Disablement" section
- CUT-OFF → Imminent shutdown
- FAULT → At least one fault active
- OK → Operating properly

Main Power → Main power supply connected to the primary power mains, status can be OK or FAULT.

Backup Power → Backup power supply connected to the buffer batteries, the status can be OK or FAULT.

Charger status → Buffer battery charger; its status can be OK or FAULT.

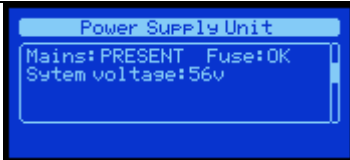

The second screen summarises the status of the main power supply unit, which draws the primary power supply from the primary power mains.

- Mains: PRESENT** → Primary power mains connected and present
- ABSENT** → Primary power mains disconnected and absent

Indicates the status of the system protection fuse from the primary power mains.

- Fuse OK** → Fuse intact
- BLOW** → Fuse blown or removed

For completeness, the value in volt of the internal primary power supply distributed to all system components (Amplifiers, Charger, etc.) is indicated

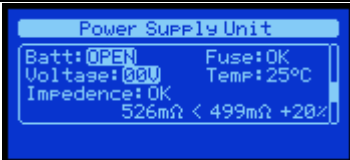

The third screen summarises the status of the backup power supply unit, which draws the secondary power supply starting from the battery pack.

- Batt: PRESENT** → Battery pack present and connected
- ABSENT** → Battery pack removed
- SHORT** → Battery pack in short-circuit
- OPEN** → Open wiring / battery pack disconnected
- OVERTEMP** → The battery temperature is too high
- UNDERTEMP** → The battery temperature is too low

The status of the battery protection fuse is indicated.

- Fuse OK** → Fuse intact
- BLOW** → Fuse blown or removed

The value in volt of the battery pack read by the system and the temperature in degrees centigrade are indicated.

Presence of the impedance status of the battery pack:

- Impedance: OK** → Impedance of the battery pack detected and correct
- NOT CALIB** → Impedance of the battery pack not calibrated
- ERROR** → Impedance of the battery pack out of range, used batteries or to be re-calibrated
- WARNING** → Impedance of the battery pack near the fault threshold

For completeness, the display indicates the measured impedance value and the calibration value with the fault threshold in percentage.

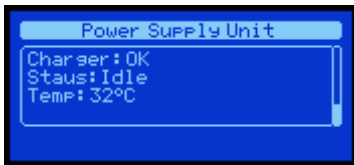

The fourth screen summarises the operating status of the battery pack charger.

Charger: **FAULT** → Faulty charger
OK → Operating charger

It shows the details of the operating status:

Status: **CIRCUIT FAIL** → Faulty charging circuit
OVERTEMP → The charging circuit temperature is too high
IN CHARGE → The charging circuit is operating and the charge is in progress
IDLE → The charging circuit is operating and the charge is not in short-circuit

For completeness it indicates the charging circuit temperature in degrees centigrade.

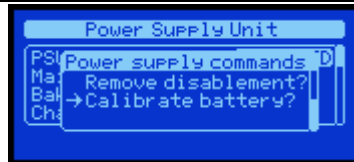

To access the POP-UP where to insert or remove the “disablement” condition, you must have access level 2, otherwise a screen is displayed where you are required to login to carry out this operation.

From the POP-UP, with the section in “disablement” you can calibrate the battery pack impedance by selecting the “Calibrate battery” command; execution is not immediate and requires a few seconds; at the end the outcome is shown on the status detail screens. This operation measures the battery pack impedance to continuously evaluate any changes denoting a degradation.

NOTE: When the “Power supply unit” is in “disablement” all safety functions related to the power supply are deactivated. Any “FAULTS” are also removed. The “disablement” function allows working on the batteries without interrupting the system operation and without generating “FAULTS.”

FIRE MICROPHONE Menu



The *Fire microphone list* menu allows you to view and manage the status of the microphone workstations used to issue emergency messages both locally or via microphone on the system front panel and remote bases connected by bus. They appear in the form of a list and can be scrolled using the UP and DOWN arrows. Each microphone workstation is linked to a summary status:

The local microphone workstation, with microphone on the system front panel:

Local Fire Mic: **DISABLED** → Disabled, in “disablement”
FAULT → At least one fault active
OK → Operating, no fault detected

Remote emergency microphone workstation:

Remote Fire Mic: **DISABLED** → Disabled, in “disablement”
NOT IN USE → Disabled, not connected
FAULT → At least one fault active
OK → Operating, no fault detected

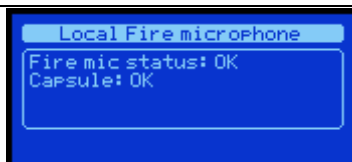

For the details of the status of the emergency microphone workstations you can select from the list and press OK to access the *Local Fire microphone* screen in case of local microphone workstation, *Remote Fire microphone* in case of remote microphone workstations, in both cases the status is shown in detail.

Details of the operating status for the local microphone workstation:

Fire Mic Status: **DISABLED** → Disabled, in “disablement”
FAULT → At least one fault active
OK → Operating, no fault detected

Details the status of the microphone capsule:

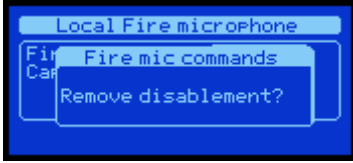

	<p>Capsule:</p> <p>OPEN → Microphone capsule or wiring interrupted</p> <p>SHORT → Microphone capsule or wiring in short-circuit</p> <p>OK → Microphone capsule and wiring intact</p>
	<p>Details of the operating status for the remote microphone workstation:</p> <p>Fire Mic Status:</p> <p>DISABLED → Disabled, in “disablement”</p> <p>FAULT → At least one fault active</p> <p>OK → Operating, no fault detected</p> <p>Details of the connection to the system for the remote workstation:</p> <p>Communication:</p> <p>FAULT → Communication error</p> <p>OK → Communication operating</p> <p>Details the status of the microphone capsule:</p> <p>Capsule:</p> <p>OPEN → Microphone capsule or wiring interrupted</p> <p>SHORT → Microphone capsule or wiring in short-circuit</p> <p>OK → Microphone capsule and wiring intact</p>
	<p>To access the POP-UP where to insert or remove the “disablement” condition, you must have access level 2, otherwise a screen is displayed where you are required to login to carry out this operation.</p> <p>From the POP-UP, with the section in “disablement” you can replace the local microphone without the system reporting the fault. It is also possible, from the “disablement” condition, to remove a remote microphone workstation without the system reporting the fault.</p> <p>NOTE: When the “Fire microphone” section is in “disablement”, all functions linked to the emergency microphone workstations are deactivated. Any “FAULTS” are also removed.</p>

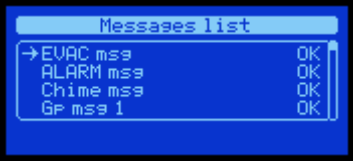
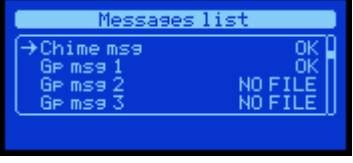
<h3>Menu MESSAGES</h3>	
	<p>The <i>Messages list</i> menu allows you to view and manage the status of the system messages pre-recorded on uSD as file with .wav extension. They appear in the form of a list and can be scrolled using the UP and DOWN arrows. Each message/file in the list is linked to the summary status:</p> <p>DISABLED → Message in “disablement”</p> <p>NO uSD → No uSD or not detected</p> <p>BAD uSD → uSD unusable</p> <p>NO IMPRINT → File image not created / File not loaded</p> <p>NO FILE → File/message not present</p> <p>FAULT → File/message in error</p> <p>OK → File/message OK</p>
	<p>11 messages can be managed:</p> <p>EVAC → Evacuation message (Controlled)</p> <p>ALARM → Generic alarm message (Controlled)</p> <p>CHIME → “Din-Don” message</p> <p>Gp msg 1-8 → Generic message</p> <p>The evacuation and alarm messages are continuously controlled to verify their integrity.</p> <p>Files format:</p> <p>Evacuation message → EVAC → evac.wav</p> <p>Generic alarm message → ALARM → alarm.wav</p>



"Din-Don" message → CHIME → chime.wav
 Generic message 1:8 → Gp msg 1:8 → msg1.wav / msg8.wav
 Files must have the following characteristics: Format **WAV, 48KHz, MONO, 16bit**
 Position of files: Files must be saved in the uSD root, that is not within sub-folders.
 uSD formatting: To format the uSD, see the dedicated chapter

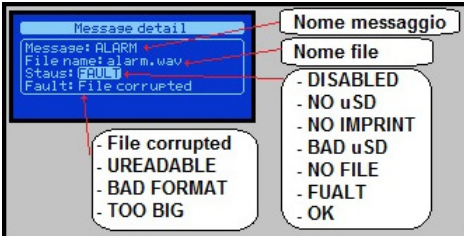

For details of the status of a message, you can select it from the list and press OK to access the *Message detail* screen that indicates the status in detail. In particular, the display shows the type of message, the file name, the status and the possible error.

Faults are as follows:

FILE CORRUPTED	→ File corrupted
UNREADABLE	→ File unreadable
BAD FORMAT	→ Incorrect file format
TOO BIG	→ Excessive file size

To access the POP-UP where to insert or remove the "disablement" condition, you must have access level 2, otherwise a screen is displayed where you are required to login to carry out this operation.

From the POP-UP you can listen to the selected message on the monitor loudspeaker, without playing it on the speakers.

By placing the whole section of messages in "disablement", you can safely remove the uSD to add or remove messages/files.

File names are fixed and formats must be adhered to so that the system recognises the messages/files; if a file has a different name from those expected, it is ignored.

For the system to create the image of the files, the section must be in "disablement"; insert the uSD with the messages/files in the correct format, select the "Get uSD imprint" command and at the end of the validation process, still in disablement, you can verify the validation result by scrolling the status of the messages/files in the detail screen. To activate new messages, remove "disablement."

NOTE: When the uSD section is in "disablement" all system functions related to pre-recorded messages are deactivated; the uSD is off and can be safely removed. Any "FAULTS" related to messages are also removed. The "disablement" function allows working on messages without interrupting the system operation and without generating "FAULTS."



INPUT CONTACTS Menu

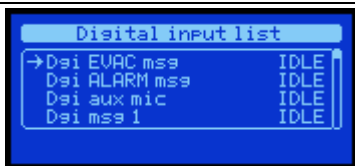

The *Digital input list* menu allows you to view the status of the system digital inputs, in the form of a list, and you can scroll them using the UP and DOWN arrows. Each input in the list is linked to a summary status:

DISABLED → Input in “disablement”

FAULT → Faulty input

ACTIVE → Active input

IDLE → Idle input

For an input status details, you can select it from the list and press OK to access the *Digital input detail* screen that indicates the status in detail. In particular, the display shows the name of the input, the condition, the status and the possible active error. Faults are as follows:

CABLE CUT → Cable cut, connector removed

CABLE SHORT → Cable in short-circuit

CIRCUIT FAILURE → Faulty control circuit

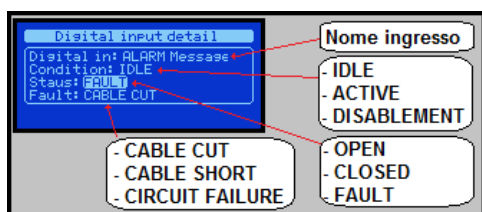

To access the POP-UP where to insert or remove the “disablement” condition, you must have access level 2, otherwise a screen is displayed where you are required to login to carry out this operation.

By placing the whole section of inputs in “disablement”, you can work on the wiring, preventing the system from reporting faults or accidentally launching a message. At the end of the wiring operations, remove the “disablement” condition.

NOTE: When the input section is in “disablement”, all system functions related to the input contacts are deactivated. Any “FAULTS” related to wiring are also removed. The “disablement” function allows working on the wiring without interrupting the system operation and without generating “FAULTS”.

ETHERNET Menu

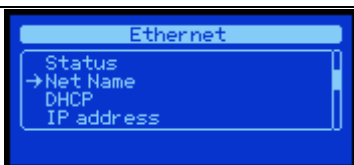

The ETHERNET menu manages the network features. You can view the interface status and configure the operating parameters. The functions are shown as a list and can be browsed using the UP and DOWN arrows. When the desired selection is pointed by the arrow, press OK to access the section.



ETH STATUS Sub-menu

The *ETH STATUS* menu displays the the network interface status of connection.

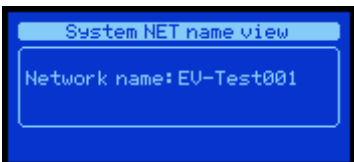

The System NET name view sub-menu allows you to view and configure the name of the system network.

To change the network name simply press OK to access the System NET name conf screen to enter the desired data, compose the name by changing one letter at a time until you get the desired combination; use the right and left arrows to move between letters and the up and down arrows to change the value of the selected letter. When all letters coincide with the desired settings, simply press OK to save them; press **BACK** to cancel the changes.

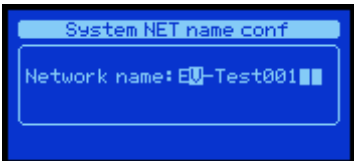

To change the network configuration you must have access level 2, if not a screen is displayed where you are required to login to carry out this operation.

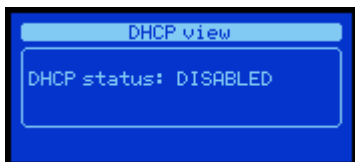

The DHCP View sub-menu allows you to view and configure the manual or automatic IP address allocation via allocation from DHCP server. To change the option, simply press OK to access the DHCP conf screen to set the DHCP ENABLED or DISABLED parameter. To change the network configuration you must have access level 2, if not a screen is displayed where you are required to login to carry out this operation.

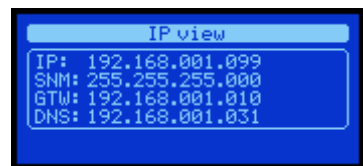
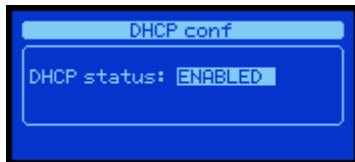

The IP view sub-menu allows you to view and configure the system network configuration parameters.

Configurable parameters are the IP network address, the Subnet Mask, the Gateway address and the DNS address.

To change network parameters simply press OK to access the IP conf screen to enter the desired data, compose the addresses by changing one digit at a time until you get the desired combination; use the right and left arrows to move between digits and the up and down arrows to change the value of the selected digit. When all digits coincide with the desired settings, simply press OK to save them; press BACK to cancel the changes.

To change the network configuration you must have access level 2, if not a screen is displayed where you are required to login to carry out this operation.

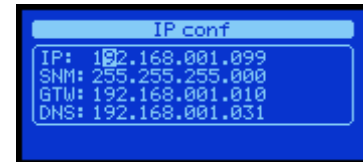

SYSTEM CONF LIST Menu

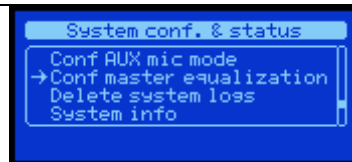
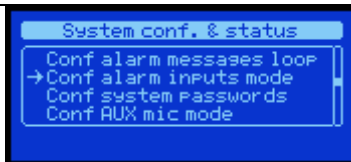
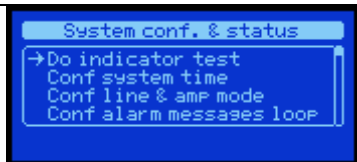

The SYSTEM CONF LIST menu allows you to configure the system. Below the description and use of each section

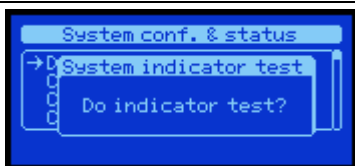

In the **DO INDICATOR TEST** sub-menu, the *System indicator test* option allows you to test all system indicators.

By pressing OK all indicators will turn on for 2 seconds - even the display will turn completely white - and the acoustic indicators will emit a continuous beep. If an indicator is off during this operation, or some pixels do not turn white, or no sound is heard from the system, contact the service centre and report the fault.

The test can be run at access level 1

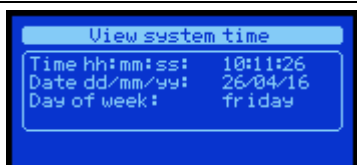

The **CONF SYSTEM TIME** sub-menu allows you to view and configure the system date and time.

To change the system date and time simply press OK to access the *Set system time* screen. Select the field to be changed with the RIGHT and LEFT arrows and select the desired value with the UP and DOWN arrows.

To save the configuration, simply press OK, press BACK to cancel the changes.

To change the system date and time you must have access level 2, if not a screen is displayed where you are required to login to carry out this operation.

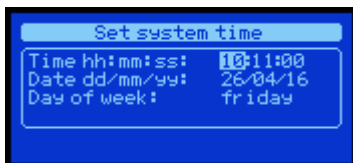

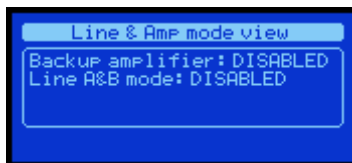

The **CONF LINE & AMP MODE** sub-menu allows you to view and configure the backup amplifier and the line operation in A&B mode.

The system provides the operation with or without backup amplifier:

Backup amplifier: DISABLED / ENABLED → Backup amplifier: NOT ACTIVE / ACTIVE

The system provides the operation with the speaker line in single or A&B mode:

Line A&B mode: DISABLED / ENABLED → A&B Line mode: NOT ACTIVE / ACTIVE

In case of ACTIVE A&B line mode, you can configure the volume delta to be applied, in case of a line fault, to the one still working. In fact, the A&B mode allows you to independently manage the line faults and, in case of a fault, isolate the faulty line and simultaneously recover the lost sound pressure by transferring power on the line not in error.

To change the operating parameters simply press OK to access the *Line & Amp mode config* screen. Select the desired setting with the RIGHT and LEFT arrows and select the desired value with the UP and DOWN arrows.

To save the configuration, simply press OK, press BACK to cancel the changes.

To change the backup amplifier configuration and the operation of the line in A&B mode you must have access level 3, if not a screen is displayed where you are required to login to carry out this operation.

NOTE: changing the operating mode of the line cancels the calibration values of the line impedance and blocks the management of the line and amplifiers in the *disablement* condition.

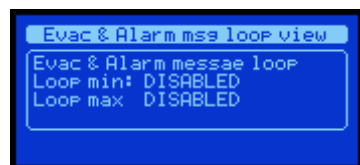

The **CONF ALARM MESSAGE LOOP** menu allows you to view and configure the minimum and maximum number of repetitions of the pre-recorded alarm and evacuation messages.

The minimum number establishes how many times the pre-recorded message is played before accepting the stop command; the parameter can be disabled by setting the value 0 = DISABLED.

The maximum number establishes how many times at most the pre-recorded message is played before it is automatically terminated; the parameter can be disabled by setting the value 0 = DISABLED.

The parameters of minimum and maximum number of message playback are only applied to alarm and evacuation messages.

NOTE: if the configuration of minimum or maximum playback is active for pre-recorded messages during playback, the main screen will display the  symbol.

To change the operating parameters, simply press OK to access the *Evac & Alarm msg loop config* screen. Select the desired setting with the RIGHT and LEFT arrows and select the desired value with the UP and DOWN arrows.

To save the configuration, simply press OK, press BACK to cancel the changes.

To change the minimum and maximum number of alarm and evacuation pre-recorded message playback, you must have access level 3, if not a screen is displayed where you are required to login to carry out this operation.

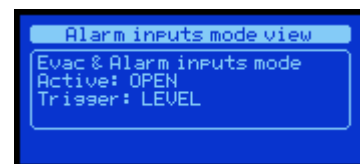

The **CONF ALARM INPUT MODE** menu allows you to view and configure the operating mode of the inputs associated to the alarm and evacuation pre-recorded messages.

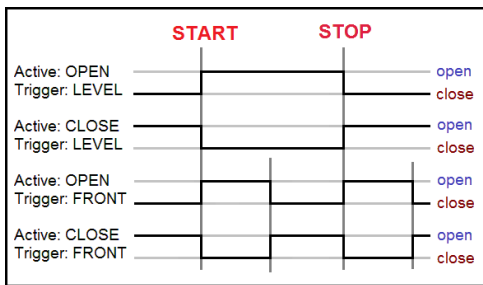

An input can be active when closing or opening the contact and work on front lines or on level.

Active: OPEN/CLOSE → Active: OPENING / CLOSING
 Trigger: LEVEL/FRONT → Mode: LEVEL / FRONT

To change the operating parameters, simply press OK to access the *Alarm inputs mode config* screen. Select the desired setting with the RIGHT and LEFT arrows and select the desired value with the UP and DOWN arrows.

To save the configuration, simply press OK, press BACK to cancel the changes.

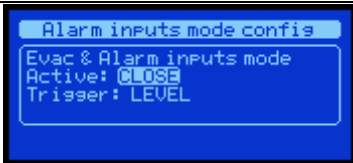

NOTE: If you configure the inputs in TRIGGER = FRONT mode the start and stop of the message takes place during transition from OPEN→CLOSE contact or vice-versa; for this reason when powered the system will not be able to detect an active contact. Vice-versa, if you configure the inputs in TRIGGER = LEVEL mode the start and stop of the message takes place following the status of the input which can be active CLOSED or OPEN; for this reason, if the contact is active when the system is turned on and after the start-up sequence, the message will be immediately launched.

To change the operating configuration of the inputs associated with the alarm and evacuation pre-recorded messages, you must have access level 3, if not a screen is displayed where you are required to login to carry out this operation.

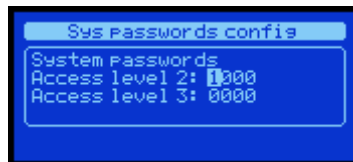
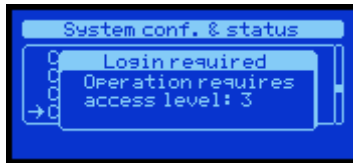
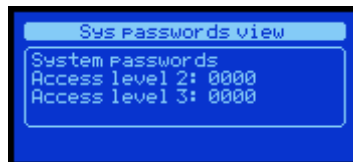

The **CONF SYSTEM PASSWORDS** menu allows you to view and configure the system access passwords. The current password to access level 2 and the password to access level 3 are displayed.

To change them simply press OK to access the *Sys password config* screen; to enter the password compose it by changing one digit at a time until you get the desired combination; use the right and left arrows to move between digits and the up and down arrows to change the value of the selected digit. When all digits coincide with the password to be entered, simply press OK to save them; press BACK to cancel the changes.

To change the system password you must have access level 3, if not a screen is displayed where you are required to login to carry out this operation.

NOTE: if the passwords to access level 2 and 3 coincide, at the time of authentication the system will authenticate the highest level, that is 3.

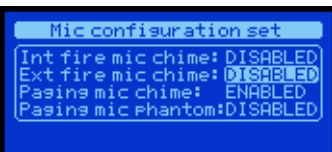
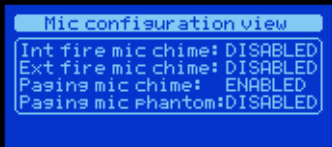

The **MIC CONFIGURATION MODE** menu allows you to view and configure the operating parameters of the system microphones.

In particular, you can enable or disable the playback of the *chime* on the integrated VVF microphone, on the remote VVF microphone and on the *paging* microphone. It is also possible to activate or deactivate the *phantom* voltage output for the paging microphone in order to power dynamic microphones.

For each item you can set the values:

DISABLED → Off or disabled / ENABLED → On or enabled

To change the parameter, simply press OK to access the *MIC configuration mode* configuration screen. Select the desired setting with the RIGHT and LEFT arrows and select the desired value with the UP and DOWN arrows. To confirm the configuration press OK to cancel the changes press BACK. The configured values are applied at the time of confirmation.

To change the microphone configuration you must have access level 3, if not a screen is displayed where you are required to login to carry out this operation.

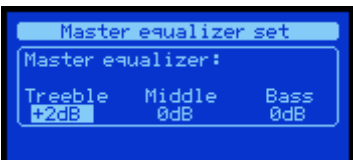
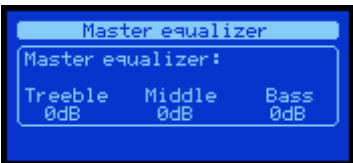
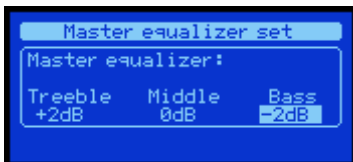

The **CONF MASTER EQUALIZER** menu allows you to view and configure the equalisation parameters of the system audio output. You can configure treble, medium and bass tones; configurable values are expressed in decibels referred to 0dB.

The configurable values for each band are: -15dB, -12 dB, -10 dB, -8 dB, -6 dB, -4 dB, -2 dB, -1 dB, 0 dB, +1 dB, +2 dB, +4 dB, +6 dB, +8 dB, +10 dB, +12 dB, +15 dB

To configure an equalisation value, simply press OK to access the *Master equalizer set* configuration screen.

Select the band to be changed with the RIGHT and LEFT arrows and select the desired value with the UP and DOWN arrows. To confirm the configuration press OK; to cancel the changes, press BACK. The configured values are applied in real time during parameter editing.

To change the system equalisation you must have access level 2, if not a screen is displayed where you are required to login to carry out this operation.

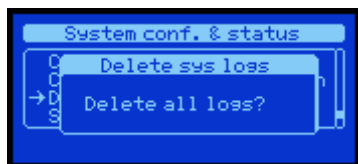
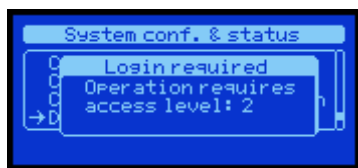

The **DELETE SYSTEM LOGS** menu allows you to delete all *Logs* system events; to complete the operation, simply press OK; to cancel press BACK.

To perform this operation you must be logged in at access level 2, otherwise a POP-UP will appear indicating the need to login at access level 2 to complete the operation.

NOTE: The deletion of all *Logs* will empty the list of recorded events and will write a *Log* deletion event.

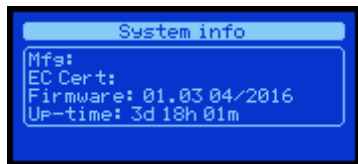

The **SYSTEM INFO** menu displays the system information:

- Mfg:** → System manufacturer
- EC Cert:** → CE certificate number
- Firmware:** → Version of the uploaded software
- Up-Time:** → On time (dd - days / hh - hours / mm - minutes)



SYSTEM VOLUMES Menu

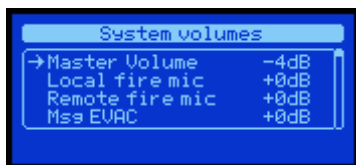

The **SYSTEM VOLUMES** menu allows you to view and independently configure the volume of each system sound source.

The volumes are displayed as a list and it is expressed in decibel referred to 0dB.

Configurable volumes are:

- Master volume → System master volume
- Local fire mic → Volume of the PTT emergency microphone
- Remote fire mic → Volume of the remote emergency microphone
- Msg EVAC → Volume of the pre-recorded evacuation message
- Msg ALARM → Volume of the pre-recorded alarm message
- Bgm Music → Volume of the background music
- Msg Chime → Volume of the pre-recorded announcement message (Din-Don)
- Msg Gpo # → Volume of the pre-recorded generic message (1-8)

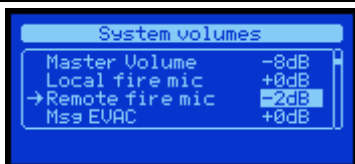

To configure a volume simply select the source using the UP and DOWN arrows and press OK, the pointed volume will be highlighted; using the UP and DOWN arrows, you can change its value, pressing OK saves and applies the value. When configuring the displayed value is applied in real time, press BACK to go back to the previous value.

The configurable volume values for each source are: MUTE, -60dB, -50 dB, -42 dB, -36 dB, -30 dB, -24 dB, -20 dB, -16 dB, -12 dB, -10 dB, -8 dB, -6 dB, -4 dB, -3 dB, -2 dB, -1 dB, 0 dB, +1 dB, +2 dB, +3 dB, +6 dB

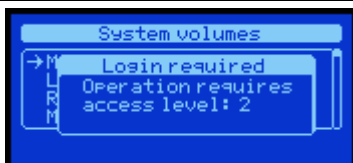

To change the volumes of the machine emergency functions you must have access level 2, if not a screen is displayed where you are required to login to carry out this operation.



MESSAGE SCHEDULER Menu

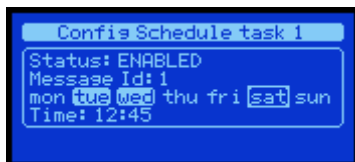
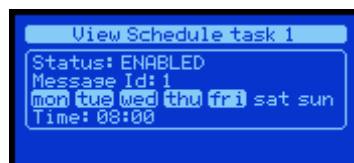
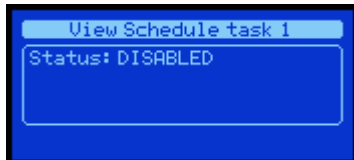
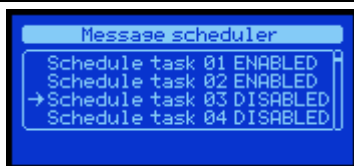

The **MESSAGE SCHEDULER** menu allows you to view and configure the launching of a pre-recorded message according to a repetitive time schedule. The system provides for a maximum of 24 time schedules that are displayed in the form of a list. Each *Task* programming is numbered (01-24) and indicates whether it is *ENABLED* or *DISABLED*. You can view the details for each *Task* programming via the *View schedule task xx* where, in the window title, xx indicates the number of the selected *Task*. If the *Task* is disabled only the word *DISABLED* is displayed to indicate that that *Task* is not active.

If, on the contrary, the *Task* is active, the following information is displayed:

- Numeric identification of the pre-recorded message that will be automatically launched.
- Days of the week when the message will be automatically launched (Mon = Monday, Tue = Tuesday, Wed = Wednesday, Thu = Thursday, Fri = Friday, Sat = Saturday, Sun = Sunday)
- Time when the message will be automatically launched (hh:mm)

To understand whether a weekday is active: **mon** = NOT ACTIVE / **mon** = ACTIVE

When the task is active, the display shows a cursor that highlights the editable field; use the right and left arrows to move between editable fields. Use the UP and DOWN arrows to edit the selected fields. Press OK to save changes. Press BACK to discard the changes and the *Task* configuration is not modified.

NOTE: The identified message will be automatically launched every active day of the week at the configured time; for multiple repetitions on the same weekday, you must use multiple *Tasks*.

SYSTEM LOGS Menu

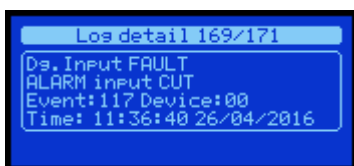

The **SYSTEM LOGS** menu displays the System events stored in *Logs* events. The number of stored events can vary and is shown in the window title. (Example: if the *Logs* are deleted the list will only contain a log indicating the deletion of all *Logs*). Both the system events list screen *Logs list xxx/zzz* and the system event detail screen *Logs detail xxx/zzz* display the number of the selected event and the total number of the stored events *Logs list XXX / ZZZ* where **XXX** is the number of the selected Log and **ZZZ** the total number of logs.

In the system *Logs* list screen you can chronologically browse the system events, the first *Log* of the list (e.g. No.171/171) is the most recent event, using the DOWN arrow you can view the *Logs* that took place before.

To view the details of an event simply select it from the list using the UP and DOWN arrows and press OK. A new screen will appear showing all data relating to the selected event: Text description on two rows, event *Id*: and source of the event *Device*:

Each event is accompanied by the date and time when it was recorded according to the standard hh:mm:ss dd/mm/yyyy, where:

hh → hour(00-24) / mm → minutes (00-59) / ss → seconds (00-59) / dd → day (01-31) / mm → month (01-12) / yyyy → year (20xx)

The full list and related codes are detailed in the dedicated section.



ACCESS LEVEL LOGIN Menu

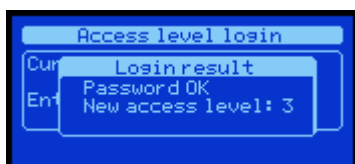
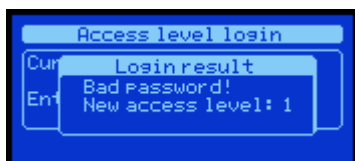
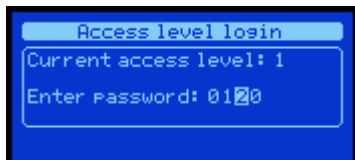
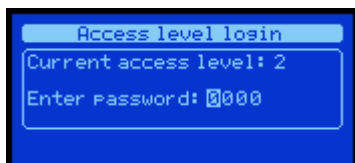

The **ACCESS LEVEL LOGIN** menu allows the user to login and obtain the desired access rights. The system provides three access levels 1 – 2 – 3 where level 1 has the lowest priority and level 3 has the highest priority. The screen displays the current access level.

To login you must know the password of the desired access level. An incorrect password takes the system to access level 1.

To enter the password you must compose it by changing one digit at a time until you get the desired combination; use the right and left arrows to move between digits and the up and down arrows to change the value of the selected digit. When all digits coincide with the password to be entered, simply press OK to proceed with the validation. If the password is incorrect, a POP-UP will appear indicating the new access level obtained. If the password is incorrect, a POP-UP will appear indicating the new access level of 1.

NOTE: if the passwords to access level 2 and 3 coincide, at the time of authentication the system will authenticate the highest level, that is 3.

SYSTEM FAULT

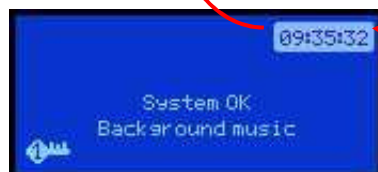
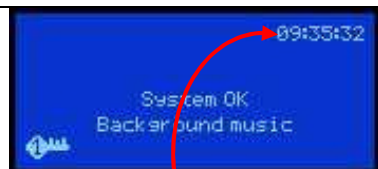

The SYSTEM FAULT signal is achieved with a flashing indication on the frontpanel display. In a normal operating condition, the system time will flash inside a frame. If for any reason the time indicator stops flashing, the unit will be in a SYSTEM FAULT condition. In that case, after 10 seconds, approximately, a watchdog timer will force a reset that will reboot the unit.

6. PROCEDURES and USING THE SYSTEM

7.1 Authentication

- 1) Access the menu: press OK from the main screen and access the list of menus.

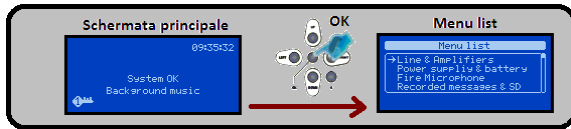

- 2) Select "Access level login" in the menu list using the UP and DOWN keys, press OK to access the menu.

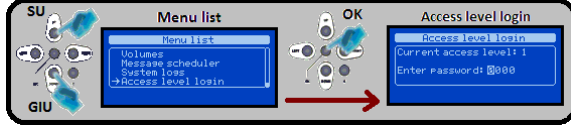

- 3) Compose the password using the UP and DOWN keys to edit the digit highlighted by the cursor, use the RIGHT and LEFT keys to select the digit to be modified moving the cursor.



- 4) After the correct password has been composed with all digits, press OK to login. A POP-UP screen indicates the new access level; if the password is incorrect the access level will be 1, if correct you can access at level 2 or 3 depending on the entered password.

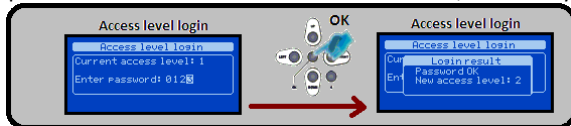

- 5) Exit the menu by pressing the BACK key repeatedly.

7.2 Speaker Line Calibration

- 1) Access the menu: press OK from the main screen and access the list of menus. To run the procedure you must be logged-in to access level 2

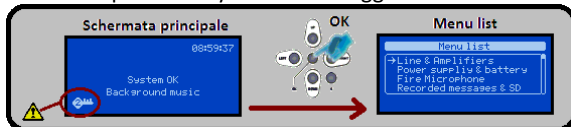

- 2) Select "Line & Amplifiers" in the menu list using the UP and DOWN keys, press OK to access the menu.

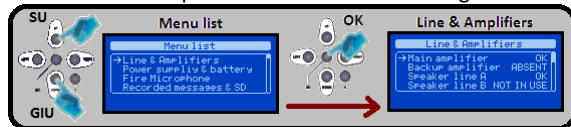

- 3) Select "Main amplifier" in the list and press OK to access the menu

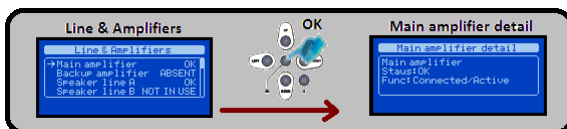

- 4) In the "Main amplifier" screen press OK to access the POP-UP "Line & Amp commands" and press OK to place the section in "disablement."

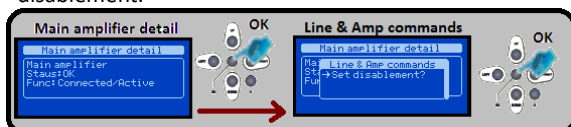

- 5) In the "Main amplifier" screen press OK to access the POP-UP "Line & Amp commands."

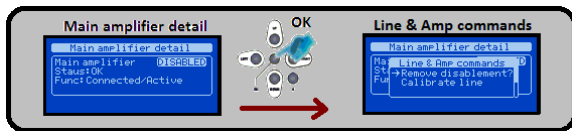

- 6) Select "Calibrate line" using the UP and DOWN keys and activate the calibration of the line of speakers by pressing the OK key.



- 7) Select "Main amplifier" in the list and press OK to access the menu.

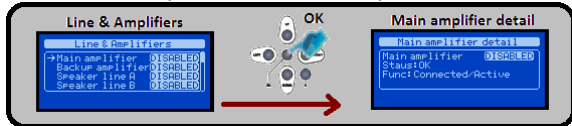

- 9) In the "Main amplifier" screen press OK to access the POP-UP "Line & Amp commands" and press OK to remove the section from "disablement."



- 10) Exit the menu by pressing the BACK key repeatedly.

7.3 Battery Calibration

- 1) Access the menu: press OK from the main screen and access the list of menus. To run the procedure you must be logged-in to access level 2.

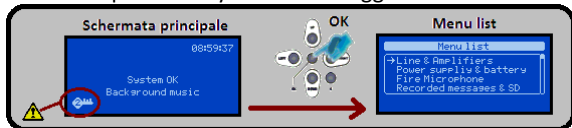

- 2) Select "Power Supply Unit" in the menu list using the UP and DOWN keys, press OK to access the menu.

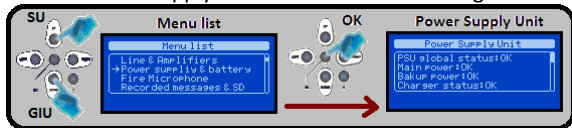

- 3) In the "Power Supply Unit" screen press OK to access the POP-UP "Power supply commands" and press OK to place the power supply section in "disablement."

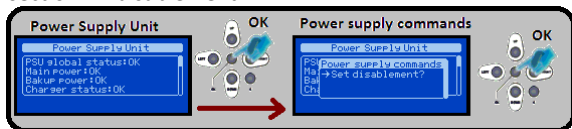

- 4) In the "Power Supply Unit" press OK to access the POP-UP "Power supply commands."

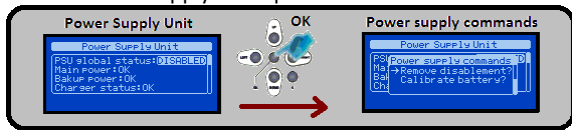

- 5) Select "Calibrate battery" using the UP and DOWN keys and activate the calibration of the battery impedance by pressing the OK key. The operation lasts for about twenty minutes during which a POP-UP screen will indicate the time remaining to the end of the operation.



- 6) In the "Power Supply Unit" screen press OK to access the POP-UP "Power supply commands" and press OK to remove the section from "disablement."

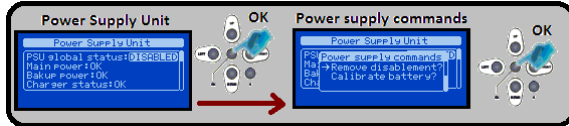

- 7) Exit the menu by pressing the BACK key repeatedly.

7.4 Volume Setting

- 1) Access the menu: press OK from the main screen and access the list of menus. To run the procedure you must be logged-in to access level 2.

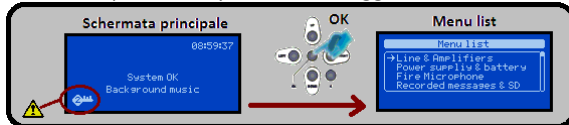

- 2) Select "System volumes" in the menu list using the UP and DOWN keys, press OK to access the menu.



- 3) Select the volume to be modified from the list using the UP and DOWN keys, press OK to modify the volume value.

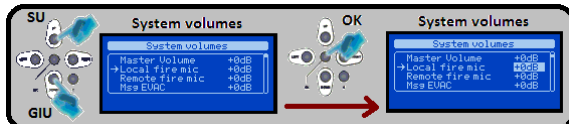

- 4) Modify the selected volume using the UP and DOWN keys until you reach the desired value, then press OK to save the change.

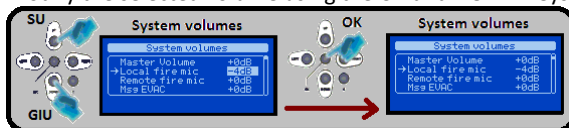

- 5) Exit the menu by pressing the BACK key repeatedly.



7. TABLE OF EVENTS, FAULTS and TROUBLESHOOTING

EVENT	LOG words	LOG detail	POP-UP words	Event description	Action
SYS	System power ON	System power ON Startup successful		System on, the event is recorded at the end of the start-up sequence.	
SYS	System old rtc time	System time setup event Log previous rtc time		Edit system date and time, the event is recorded with the date and time prior to the change.	
SYS	System new rtc time	System time setup event Log new rtc time		Edit system date and time, the event is recorded with the date and time after the change.	
SYS	System logs deleted	All system logs deleted by user		Deletion of system events by user command. All LOG have been deleted.	
SYS	Auth access level 2	Authentication event Current access level 2		Authentication to access level 2	
SYS	Auth access level 3	Authentication event Current access level 3		Authentication to access level 3	
VOICE ALARM	Local fire mike START	Alarm message START Local fire mike	Local fire microphone	Launch of an alarm message from integrated alarm microphone.	
VOICE ALARM	Local fire mike STOP	Alarm message STOP Local fire mike		Stop of an alarm message from integrated alarm microphone.	
VOICE ALARM	Remote fire mike START	Alarm message START Remote fire mike	Remote fire mic	Launch of an alarm message from remote alarm microphone.	
VOICE ALARM	Remote fire mike STOP	Alarm message STOP Remote fire mike		Stop of an alarm message from remote alarm microphone.	
VOICE ALARM	Eth alarm talk START	Alarm message START From Ethernet	ETH Alarm talk	Launch of an alarm message from ethernet.	
VOICE ALARM	Eth alarm talk STOP	Alarm message STOP From Ethernet		Stop of an alarm message from ethernet.	
VOICE ALARM	EVAC message START	EVAC message START From uSD Player	Evac Message playback	Start playback of evacuation message from uSD.	
VOICE ALARM	EVAC message STOP	EVAC message STOP From uSD Player		Stop playback of evacuation message from uSD.	
VOICE ALARM	ALARM message START	ALARM message START From uSD Player	Alarm Message playback	Start playback of alarm message from uSD.	
VOICE ALARM	ALARM message STOP	ALARM message STOP From uSD Player		Stop playback of alarm message from uSD.	
FAULT WARNING	Line NOT calibrated	Line calibration FAULT Line is not calibrated	No line calibration	Error: Line not calibrated	Calibrate the line of speakers
	Line calibrated	Line calibration RESUME Line is now calibrated		The event is stored at the end of the line calibration procedure with positive outcome.	
	Line calibration fault	Line calibration FAULT Unable to cal line	Line calibration error	The event is stored at the end of the line calibration procedure with negative outcome.	
	Line cal resume	Line calibration RESUME Line is correctly cal		Error of uncalibrated line restored	
FAULT WARNING	Main amp FAULT	Main amplifier FAULT Amplifier is unusable	Main amplifier fail	Primary amplifier fault.	Contact the technical service centre.
	Main amp RESUME	Main amplifier RESUME Main amp is GOOD		Primary amplifier fault restored	
	Main amp OVERTEMP	Main amplifier OVERTEMP Amplifier is overheating		Primary amplifier overheating.	Check the System ventilation.
	Main amp T RESUME	Main ampl temp RESUME Temperature range is OK		The operating temperature of the primary amplifier falls within the specification parameters.	
FAULT WARNING	Backup amp FAULT	Backup amplifier FAULT Amplifier is unusable	Backup amplifier fail	Backup amplifier fault.	Contact the technical service centre.
	Backup amp RESUME	Backup amplifier RESUME Backup amp is GOOD		Backup amplifier fault restored	
	Backup amp OVERTEMP	Backup amp OVERTEMP "Amplifier is overheating		Backup amplifier overheating.	Check the System ventilation.
	Backup amp T RESUME	Backup amp temp RESUME Temperature range is OK		The operating temperature of the backup amplifier falls within the specification parameters.	
FAULT WARNING	Line A GROUND SHORT	Line A GROUND SHORT Line shorted to EARTH	Line A short to GND	Speaker line A short-circuited to earth.	Check the speaker line A.
	Line A GND SHORT RESUME	Line A gnd short RESUME Line A isolation is OK		Fault of line A short-circuited to earth restored.	
FAULT WARNING	Line A NO LOAD	Line A LOAD FAULT Line A is OPEN	Line A no load	Complete loss of line A load.	Check the speaker line A.
	Line A NO LOAD RESUME	RESUME from open line A Line A load is GOOD		Fault of complete loss of line A load restored.	
FAULT WARNING	Line A UNDERLOAD	Line A LOAD FAULT Line A UNDERLOAD	Line A underload	Partial loss of line A load.	Check the speaker line A.
	Line A UNDERLOAD RESUME	RESUME from underload A Line A load is GOOD		Fault of partial loss of line A load restored.	
FAULT WARNING	Line A OVERLOAD	Line A LOAD FAULT Line A OVERLOAD	Line A overload	Increase of line A load.	Check the speaker line A.
	Line A OVERLOAD RESUME	RESUME from overload A Line A load is GOOD		Fault of increase of line A load restored.	
FAULT WARNING	Line A BAD LOAD	Line A LOAD FAULT Line A BAD LOAD	Line A bad load	Load error: impedance of speaker line A is out of specification.	Check that the impedance of speaker line A falls within the specification parameters.
	Line A BAD LOAD RESUME	RESUME from bad load A Line A load is GOOD		Load error of speaker line A restore.	
FAULT WARNING	Line A LOAD SHORT	Line A SHORT FAULT Line A is SHORTED	Line A load short	The speaker line A is in short-circuit.	Check the speaker line A.
	Line A LD SHORT RESUME	RESUME from short lin A Line A load is GOOD		Fault of short-circuited speaker line A restored.	
FAULT WARNING	Line B GROUND SHORT	Line B GROUND SHORT Line shorted to EARTH	Line B short to GND	Speaker line B short-circuited to earth.	Check the speaker line B.
	Line B GND SHORT RESUME	Line B gnd short RESUME Line B isolation is OK		Fault of short-circuited to earth line B restored.	
FAULT WARNING	Line B NO LOAD	Line B LOAD FAULT Line B is OPEN	Line B no load	Complete loss of line B load.	Check the speaker line B.



	Line B NO LOAD RESUME	RESUME from open line B Line B load is GOOD		Fault of complete loss of line B load restored.	
FAULT WARNING	Line B UNDERLOAD	Line B LOAD FAULT Line B UNDERLOAD	Line B underload	Partial loss of line B load.	Check the speaker line B.
	Line B UNDERLOAD RESUME	RESUME from underload B Line B load is GOOD		Fault of partial loss of line B load restored.	
EVENT	LOG words	LOG detail	POP-UP words	Event description	Action
FAULT WARNING	Line B OVERLOAD	Line B LOAD FAULT Line B OVERLOAD	Line B overload	Increase of line B load.	Check the speaker line B.
	Line B OVERLOAD RESUME	RESUME from overload B Line B load is GOOD		Fault of increase of line B load restored.	
FAULT WARNING	Line B BAD LOAD	Line B LOAD FAULT Line B BAD LOAD	Line B bad load	Load error: impedance of speaker line B is out of specification.	Check that the impedance of speaker line B falls within the specification parameters.
	Line B BAD LOAD RESUME	RESUME from bad load B Line B load is GOOD		Load error of speaker line B restored.	
FAULT WARNING	Line B LOAD SHORT	Line B SHORT FAULT Line B is SHORTED	Line B load short	The speaker line B is in short-circuit.	Check the speaker line B.
	Line B LD SHORT RESUME	RESUME from short lin B Line B load is GOOD		Fault of short-circuited speaker line B restored.	
FAULT WARNING	Main power LOST	Mains power FAULT Mains power is LOST	Main power loss	Absence of primary power supply	Check connection to the system power mains.
	Main power RESTORED	Mains fault RESUME Mains power RESTORED		Error of absence of primary power supply restored.	
FAULT WARNING	Main power fuse BLOW	Mains fuse FAULT Mains fuse is BLOW	Mains fuse blow	Blown primary power supply fuse.	Replace the primary power supply fuse
	Main power fuse GOOD	Mains fuse fault RESUME Mains fuse is OK		Error of blown primary power supply fuse restored.	
FAULT WARNING	Battery presence LOST	Battery presence FAULT Battery is UNCONNECTED	Batt disconnected	Disconnected backup power supply source battery.	Connect the battery pack as per the specification.
	Battery presence OK	Battery pres RESUME Battery is connected		Error of disconnected backup battery restored.	
FAULT WARNING	Battery fuse BLOW	Battery fuse FAULT Battery fuse is BLOW	Batt fuse blow	Blown backup battery fuse.	Replace the backup battery fuse.
	Battery fuse GOOD	Batt fuse fault RESUME Battery fuse is OK		Error of blown backup battery fuse restored	
FAULT WARNING	Batt temp probe SHORT	Batt temp probe FAULT Batt temp probe SHORT	Batt temp probe short	Faulty backup battery temperature probe: the connection is short-circuited.	Check the backup battery temperature probe.
	Batt temp probe GOOD	Batt T probe flt RESUME Batt temp probe is OK		Fault of short-circuited backup battery temperature probe restored.	
FAULT WARNING	Batt temp probe CUT	Batt temp probe FAULT Batt temp probe CUT	Batt temp probe cut	Faulty backup battery temperature probe: the connection is interrupted.	Check the backup battery temperature probe.
	Batt temp probe GOOD	Batt T probe flt RESUME Batt temp probe is OK		Fault of backup battery temperature probe interrupted circuit restored.	
	Chrg temp probe SHORT	Chrg temp probe FAULT Chrg temp probe SHORT	PSU temp probe short	Faulty backup battery charge circuit temperature probe: the connection is short-circuited.	Contact the technical service centre.
	Chrg temp probe GOOD	Chrg T probe flt RESUME Chrg temp probe is OK		Fault of short-circuited backup battery charge circuit temperature probe restored.	
FAULT WARNING	Chrg temp probe CUT	Chrg temp probe FAULT Chrg temp probe CUT	PSU temp probe cut	Faulty backup battery charge circuit temperature probe: the connection is interrupted.	Contact the technical service centre.
	Chrg temp probe GOOD	Chrg T probe flt RESUME Chrg temp probe is OK		Fault of interrupted circuit backup battery charge circuit temperature probe restored.	
FAULT WARNING	Battery charger FAIL	Battery charger FAULT Batt chrg is unusable	Charger failure	Faulty backup battery charge circuit.	Contact the technical service centre.
	Battery charger GOOD	Batt chrg fault RESUME Battery charger is OK		Backup battery charge circuit fault restored.	
FAULT WARNING	Batt charger OVERTEMP	Battery charger FAULT Batt charger OVERTEMP	Charger overtemp	Overheating of the battery charge circuit.	Check the System ventilation.
	Batt charger T RESUME	Batt chrg fault RESUME Batt charger temp is OK		The operating temperature of the backup battery charge circuit falls within the specification parameters.	
FAULT WARNING	Battery OVERTEMP	Battery FAULT Battery OVERTEMP	Battery over-temp	Overheating of the backup battery unit.	Check the System ventilation.
	Battery temp RESUME	Battery fault RESUME Battery temp is OK		The operating temperature of the backup battery unit falls within the specification parameters.	
FAULT WARNING	Battery UNDERTEMP	Battery FAULT Battery UNDERTEMP	Battery under-temp	Temperature of the backup battery unit below the minimum operating temperature.	Check that the environmental conditions are appropriate to the installation specifications.
	Battery temp RESUME	Battery fault RESUME Battery temp is OK		The operating temperature of the backup battery unit falls within the specification parameters.	
FAULT WARNING	Battery impedance FAIL	Battery FAULT Batt Z out of range	Batt Z out of range	Excessive drift of the backup battery impedance.	Replace the batteries and calibrate the impedance.
	Battery impedance RESUME	Battery fault RESUME Battery Z is OK		The impedance drift of the backup battery falls within the specification parameters.	
FAULT WARNING	Battery not calibrated	Batt calibration FAULT Batt is not calibrated	Batt not calibrated	Calibration error of the backup battery impedance.	Check the batteries and calibrate the battery impedance.
	Battery calibrated	Batt cal fault RESUME Battery is calibrated		Backup battery impedance calibration error corrected.	
FAULT WARNING	LOW POWER KILLING UNIT	LOW battery FAULT LOW V. - KILLING UNIT	Batt Low CUT-OFF	System running on flat backup battery. Imminent shutdown	Restore the primary power supply immediately.
	POWER KILL RESUME	Low batt fault RESUME Battery voltage is OK		Imminent shutdown condition restored.	
FAULT WARNING	PSU WATCHDOG RESET	Power Supply Unit FAULT WATCHDOG RESET	PSU WATCHDOG RESET	Indicates a forced reset (WatchDog) of the power supply unit processor.	Contact the service centre
	PSU WATCHDOG RESUME	Power Supply Unit RESUME WATCHDOG RESET	PSU WATCHDOG RESUME	Forced reset (WatchDog) of the power supply unit processor restored.	
FAULT WARNING	PSU communication FAIL	PSU communication FAULT No comm with PSU	PSU communication loss	Communication error between the power supply unit and the main processor.	Check the power supply unit connection flat-cable / contact the service centre.
	PSU comm. RESUME	PSU comm fault RESUME Comm with PSU restored		Communication between the power supply unit and the main processor restored.	Monitor the phenomenon.
FAULT	Local fire mike CUT	Local fire mike FAULT	Int fire mic cut	Removal/cut of local emergency microphone cable.	Check the local emergency



WARNING		Cable CUT			microphone connection / replace.
	Local fire mike RESUME	Loc fire mic fit RESUME Resume from cable-cut		Fault of cut local emergency microphone cable restored.	
FAULT WARNING	Local fire mike SHORT	Local fire mike FAULT Cable SHORT	Int fire mic short	Short-circuit of the local emergency microphone.	Check the local emergency microphone connection / replace.
	Local fire mike RESUME	Loc fire mic fit RESUME Resume from cable-short		Short-circuit fault of local emergency microphone restored.	
	Remote fire mic MOUNT	Remote fire mike MOUNT IDxx fire mike added		Added remote emergency microphone base.	
EVENT	LOG words	LOG detail	POP-UP words	Event description	Action
	Remote fire mic UNMOUNT	Remote fire mic UNMOUNT IDxx fire mike removed		Removed remote emergency microphone base from system	
FAULT WARNING	Rem mic comm LOST	Remote mike comm FAULT Communication ERROR	Ext fire mic com	Communication error with remote emergency microphone base	Check the base connection with the system.
	Rem mic comm RESTORED	Remote mic comm RESUME Communication restored		Communication error between remote emergency microphone base and system restored.	
FAULT WARNING	Rem mic caps CUT	Remote mic FAULT Capsule CUT	Ext fire mic cut	Fault to microphone capsule of remote emergency microphone base. Capsule interrupted.	Check the microphone / Contact the service centre.
	Rem mic caps RESTORED	Remote mic fault RESUME Capsule cut restored		Fault to microphone capsule of remote emergency microphone base.	
FAULT WARNING	Rem mic caps SHORT	Remote mic FAULT Capsule SHORT	Ext fire mic short	Fault to microphone capsule of remote emergency microphone base. Capsule in short-circuit.	Check the microphone / Contact the service centre.
	Rem mic caps RESTORED	Remote mic fault RESUME Capsule short restored		Fault to microphone capsule of remote emergency microphone base.	
FAULT WARNING	uSD no imprint	uSD imprint FAULT uSD has no imprint	No uSD imprint	Imprint of files on the uSD card not created	Create the imprint of the uSD files.
	uSD imprint done	uSD impr fault RESUME uSD imprint done		Absence error of uSD file imprint restored.	
FAULT WARNING	uSD presence LOST	uSD presence FAULT NO uSD was found	uSD absent	uSD not detected.	Insert a uSD. See uSD preparation procedure
	uSD presence RESUME	uSD pres fault RESUME uSD is present		uSD not detected error restored	
FAULT WARNING	uSD filesystem FAULT	uSD filesystem FAULT uSD is UNUSABLE	uSD bad filesystem	uSD filesystem error.	Remove the uSD and repeat the uSD preparation procedure / Replace the uSD.
	uSD filesystem RESUME	uSD filesys fit RESUME uSD is back in use		uSD filesystem error restored.	
FAULT WARNING	uSD player FAULT	uSD player FAULT Cannot play stored msg	uSD player failure	uSD file playback error.	Remove the uSD and repeat the uSD preparation procedure / Replace the uSD
	uSD player RESUME	uSD player fault RESUME Stored msg are playable		uSD file playback error restored.	
FAULT WARNING	uSD ALARM message CORRUPT	uSD ALARM message FAULT ALARM msg is CORRUPTED	uSD ALARM msg corrupt	The alarm pre-recorded message file is corrupt and cannot be played.	Remove the uSD and repeat the uSD preparation procedure / Replace the uSD
	uSD ALARM message RESUME	uSD ALARM msg fit RESUME ALARM message playable		Corrupted alarm file error restored.	
FAULT WARNING	uSD EVAC message CORRUPT	uSD EVAC message FAULT EVAC msg is CORRUPTED	uSD EVAC msg corrupt	The evacuation pre-recorded message file is corrupt and cannot be played.	Remove the uSD and repeat the uSD preparation procedure / Replace the uSD
	uSD EVAC message RESUME	uSD EVAC msg fit RESUME EVAC message playable		Corrupted evacuation file error restored.	
FAULT WARNING	Dg.Input EVAC SHORT	Dg.Input FAULT EVAC input SHORT	EVAC dgi cable short	Digital input associated with short-circuited evacuation message.	Check the wiring of the input associated with the evacuation message
	Dg.Input EVAC RESUME	Dg.Input fault RESUME EVAC restored from short		Error of digital input associated with short-circuited evacuation message restored.	
FAULT WARNING	Dg.Input EVAC CUT	Dg.Input FAULT EVAC input CUT	EVAC dgi cable cut	Digital input associated with cut cable evacuation message.	Check the wiring of the input associated with the evacuation message
	Dg.Input EVAC RESUME	Dg.Input fault RESUME EVAC restored from cut		Error of digital input associated with cut cable evacuation message restored.	
FAULT WARNING	Dg.Input EVAC HW FAIL	Dg.Input HARDWARE FAULT EVAC input failure	EVAC dgi hw failure	Faulty circuitry of digital input associated with evacuation message.	Contact the service centre.
	Dg.Input EVAC HW RESUME	Dg.In EVAC fault RESUME EVAC input hardware OK		Error of faulty circuitry of digital input associated with evacuation message restored.	
FAULT WARNING	Dg.Input ALARM SHORT	Dg.Input FAULT ALARM input SHORT	ALARM dgi cable short	Digital input associated with short-circuited alarm message.	Check the wiring of the input associated with the alarm message
	Dg.Input ALARM RESUME	Dg.Input fault RESUME ALARM restored from short		Error of digital input associated with short-circuited alarm message restored.	
FAULT WARNING	Dg.Input ALARM CUT	Dg.Input FAULT ALARM input CUT	ALARM dgi cable cut	Digital input associated with cut cable alarm message.	Check the wiring of the input associated with the alarm message
	Dg.Input ALARM RESUME	Dg.Input fault RESUME ALARM restored from cut		Error of digital input associated with cut cable alarm message restored.	
FAULT WARNING	Dg.Innput ALARM HW FAIL	Dg.Input HARDWARE FAULT ALARM input failure	ALARM dgi hw failure	Faulty circuitry of digital input associated with alarm message.	Contact the service centre.
	Dg.Input ALARM HW RESUME	Dg.In ALARM fault RESUME ALARM input hardware OK		Error of faulty circuitry of digital input associated with alarm message restored.	
	Line disablement SET	Disablement SET Line DISABLED		Amplifiers and speaker line in "disablement" management module.	
	Line disabl. REMOVED	Disablement REMOVED Line NOT disabled		Active amplifiers and speaker line (not in "disablement") management module.	
	PSU disablement SET	Disablement SET Pwr management DISABLED		Power supply in "disablement" management module.	
	PSU disabl. REMOVED	Disablement REMOVED Pwr manag. NOT disabled		Active power supply (not in "disablement") management module.	
	Mic disablement SET	Disablement SET Fire mike disabled		Emergency microphones in "disablement" management module.	
	Mic disabl. REMOVED	Disablement REMOVED Fire mike NOT disabled		Active emergency microphones (not in "disablement") management module.	



	uSD disablement SET	Disablement SET uSD DISABLED		Pre-recorded messages on uSD in "disablement" management module.	
	uSD disabl. REMOVED	Disablement REMOVED uSD NOT disabled		Pre-recorded messages on active uSD (not in "disablement") management module.	
	Dg.In. disablement SET	Disablement SET Dig inputs DISABLED		Digital inputs in "disablement" management module.	
	Dg.In. disabl. REMOVED	Disablement REMOVED Dig inputs NOT disabled		Active digital inputs (not in "disablement") management module.	
	Eth disablement SET	Disablement SET Ethernet DISABLED		Ethernet network "disablement" management module.	
	Eth disabl. REMOVED	Disablement REMOVED Ethernet NOT disabled		Active ethernet network (not in "disablement") management module.	
FAULT WARNING	DSP communication FAIL	DSP communication FAULT unable to comm with DSP	DSP communication loss	Communication error between the main processor and DSP audio processor.	Contact the service centre
EVENT	LOG words	LOG detail	POP-UP words	Event description	Action
	DSP comm. RESUME	DSP comm RESUME Comm with DSP restored		Communication error between the main processor and DSP audio processor restored.	
FAULT WARNING	Log buffer ERROR	Log buffer FAULT Buffer integrity error	Log buffer error	Storage error of the Logs system events.	Contact the service centre
FAULT WARNING	SYS WATCHDOG RESET	System power ON SYS RESET BY WATCHDOG	Watchdog system reset	Automatic restart after the system block.	Contact the service centre
FAULT WARNING	FLASH DATA FAILURE	Data Flash Corrupted CRC error	Data Flash failure	The data stored in the internal "Flash" are corrupted, the CRC calculation revealed an error.	Contact the service centre
	FLASH DATA RESTORE	Data Flash restore CRC OK		The data stored in the internal "Flash" are intact, the CRC calculation is correct	Warn the service centre

8. TECHNICAL SPECIFICATIONS

	AE300
Primary power supply	AC 230V +10% -15%; 50Hz; 350W; 1,72A Fuse 3,15A
Backup power supply	48V – integrated batteries (4x 12V 7.2°/h pb-gel) Max output current in the absence of network power supply: 8,3A Minimum absorption: 150mA (electronic cards self-consumption) Fuse 8,0A
Backup battery life	24h stand-by + 30min full power
Battery charger	I _{max} = 450mA – V _{max} = 55.2V
Output power	Single zone 300W; Z _{min} = 33,50hm line 100V
Frequency response	100Hz – 18Khz @ -3dB
Signal/noise ratio	>90dB
Backup amplifier	YES
Redundant loudspeaker line	YES (Line A, Line B)
Loudspeaker line monitoring	Line A, line B independent monitoring. Impedance measurement via 18Khz tone and FFT analysis. Detection of short-circuit, open circuit, earth leakage.
User interface	Status LEDs, display with dot matrix and keyboard for menu navigation. Keys to directly activate alarm message.
Audio processing	DSP, 16bit-48Khz; 3-band equaliser, compressor on microphone inputs, pre-gain controls, volume master, chime.
Audio inputs/outputs	Background music input, microphone balanced with phantom power supply, active sub woofer output.
Front panel monitor	YES
Emergency microphone	PTT dynamic microphone with monitoring of the capsule. RJ45 input for remote emergency workstation.
Messages activation contacts	8 contact inputs for activation to ground for generic messages
Message scheduler	YES – event structure based on internal clock and calendar
Emergency messages activation inputs	2 monitored inputs against cable cut and short-cut
Status outputs	3 open-collector outputs, max 12V. Requires external pull-up
Communication	RS485, USB-B, RJ45 10 BASE-T/100
Battery monitoring	DC resistor measurement
Certifications and conformity	EN54-16, EN54-4, BS-EN5839-8, 60849
Access levels 2 and 3	Password key selector from menu
Chassis, dimensions and weights	Powder coated steel – 12Kg excluding batteries Width 440mm, Height 11 rack unit (490mm) – Depth 150mm



9. FUNCTIONS WITH REQUIREMENT ACCORDING TO EN54-16: 2008

7.6.2	Manual silencing of the voice alarm condition	YES
7.9	Alarm condition output	YES
8.4	Indication of faults related to voice alarm zones	YES
9	Disablement condition	YES
10	Voice alarm manual control	YES
12	Emergency Microphones	YES
13.14	Redundant power amplifiers	YES

10. FUNCTIONS ACCORDING TO EN54-4: 2007

The AE300 device is equipped with a power supply unit in accordance with Standard EN54-4: 2007. The following table lists the main features implemented.

4.2.1, 4.2.2, 4.2.3	The power supply unit accepts two power supply sources: electric network (primary) and battery (secondary)
4.2.6	The primary power supply source (electrical network) is the exclusive source for the system, in addition to the currents associated with battery monitoring.
4.2.7, 4.2.10	In case of lack of main source, the device automatically switches to the backup source. When the primary source is restored, the device automatically switches back to it. Moreover, the power supply unit is built so as to ensure power supply to the system without outages in case of lack of one of the two power supply sources (network or battery).
4.2.4, 5.3.1	Automatic battery charger able to charge the battery to at least 80% of its rated capacity in 24h and 100% in the subsequent 48h
4.2.8	The lack of the primary source is indicated by appropriate "fault warning".
5.4	The device recognises and reports the following faults <ul style="list-style-type: none">a) Loss of primary power supply sourceb) Loss of backup power supply sourcec) Increase of the resistor (+25% compared to the calibrated value) inside the battery and associated circuitryd) Battery charger failuree) Blown fuses (network and battery)

MR_DIOP_03 - Rev. 01

DICHIARAZIONE DI PRESTAZIONE

Ai sensi del Reg. (UE) 305/2011 del 09/03/2011, Allegato III

N. 2016300A

1.	Codice identificativo unico del prodotto	2016300A																																																			
2.	Numero di tipo	AE300																																																			
3.	Uso previsto per il prodotto da costruzione	Apparecchiatura di controllo e segnalazione per i sistemi di allarme vocale per impianti di rilevazione e allarme incendio.																																																			
4.	Nome e indirizzo del fabbricante	Proel Spa Via Alla Ruenia, 37/43 - 64027 Sant'Omero (TE) - Italia																																																			
6.	Sistema o sistemi di valutazione e verifica della costanza della prestazione del prodotto da costruzione di cui all'Allegato V al Reg (EC) 305/2011:	1.																																																			
7.	Dichiarazione di prestazione che rientra nell'ambito di un prodotto da costruzione secondo una norma armonizzata	L'organismo notificato n. 0051, IMQ Spa, ha effettuato le prove iniziali di tipo (ITT) per le caratteristiche rilevanti del prodotto, l'ispezione iniziale di fabbrica e il controllo della produzione in fabbrica secondo il sistema 1. di cui all'Allegato V, e ha rilasciato il Certificato di Conformità 0051-CPR-0514/2017 il quale attesta che il prodotto è conforme ai requisiti prescritti dalle Norme Armonizzate EN54-16 ed EN54-4.																																																			
9.	Caratteristiche essenziali dichiarate	<table border="1"> <thead> <tr> <th colspan="3">Norma armonizzata EN54-16</th> </tr> <tr> <th>Descrizione</th> <th>Clausola/e</th> <th>Esito</th> </tr> </thead> <tbody> <tr> <td>Prestazione in caso di incendio</td> <td>4, 5, 7, 10, 12, 16.5, 16.7</td> <td>PASS</td> </tr> <tr> <td>Ritardo nella risposta</td> <td>7.1, 7.4, 7.8, 12</td> <td>PASS</td> </tr> <tr> <td>Affidabilità operativa</td> <td>4, 5, 6, 7, 8, 12, 13, 14</td> <td>PASS</td> </tr> <tr> <td>Durata dell'affidabilità del funzionamento, resistenza termica</td> <td>16.4, 16.8</td> <td>PASS</td> </tr> <tr> <td>Durata dell'affidabilità del funzionamento; resistenza a urti e vibrazioni</td> <td>16.11, 16.12, 16.13</td> <td>PASS</td> </tr> <tr> <td>Durata dell'affidabilità del funzionamento; stabilità elettrica</td> <td>16.14, 16.15</td> <td>PASS</td> </tr> <tr> <td>Durata del funzionamento; resistenza all'umidità</td> <td>16.9, 16.10</td> <td>PASS</td> </tr> </tbody> </table> <table border="1"> <thead> <tr> <th colspan="3">Norma armonizzata EN54-4</th> </tr> <tr> <th>Descrizione</th> <th>Clausola/e</th> <th>Esito</th> </tr> </thead> <tbody> <tr> <td>Prestazione dell'alimentatore</td> <td>4, 5, 6</td> <td>PASS</td> </tr> <tr> <td>Affidabilità operativa</td> <td>4, 5, 6, 7, 8</td> <td>PASS</td> </tr> <tr> <td>Durata dell'affidabilità del funzionamento, resistenza termica</td> <td>9.5</td> <td>PASS</td> </tr> <tr> <td>Durata dell'affidabilità del funzionamento; resistenza a urti e vibrazioni</td> <td>9.7, 9.8, 9.15</td> <td>PASS</td> </tr> <tr> <td>Durate dell'affidabilità del funzionamento; stabilità elettrica</td> <td>Da 9.9 a 9.13</td> <td>PASS</td> </tr> <tr> <td>Durata del funzionamento; resistenza all'umidità</td> <td>9.6, 9.14</td> <td>PASS</td> </tr> </tbody> </table>	Norma armonizzata EN54-16			Descrizione	Clausola/e	Esito	Prestazione in caso di incendio	4, 5, 7, 10, 12, 16.5, 16.7	PASS	Ritardo nella risposta	7.1, 7.4, 7.8, 12	PASS	Affidabilità operativa	4, 5, 6, 7, 8, 12, 13, 14	PASS	Durata dell'affidabilità del funzionamento, resistenza termica	16.4, 16.8	PASS	Durata dell'affidabilità del funzionamento; resistenza a urti e vibrazioni	16.11, 16.12, 16.13	PASS	Durata dell'affidabilità del funzionamento; stabilità elettrica	16.14, 16.15	PASS	Durata del funzionamento; resistenza all'umidità	16.9, 16.10	PASS	Norma armonizzata EN54-4			Descrizione	Clausola/e	Esito	Prestazione dell'alimentatore	4, 5, 6	PASS	Affidabilità operativa	4, 5, 6, 7, 8	PASS	Durata dell'affidabilità del funzionamento, resistenza termica	9.5	PASS	Durata dell'affidabilità del funzionamento; resistenza a urti e vibrazioni	9.7, 9.8, 9.15	PASS	Durate dell'affidabilità del funzionamento; stabilità elettrica	Da 9.9 a 9.13	PASS	Durata del funzionamento; resistenza all'umidità	9.6, 9.14	PASS
Norma armonizzata EN54-16																																																					
Descrizione	Clausola/e	Esito																																																			
Prestazione in caso di incendio	4, 5, 7, 10, 12, 16.5, 16.7	PASS																																																			
Ritardo nella risposta	7.1, 7.4, 7.8, 12	PASS																																																			
Affidabilità operativa	4, 5, 6, 7, 8, 12, 13, 14	PASS																																																			
Durata dell'affidabilità del funzionamento, resistenza termica	16.4, 16.8	PASS																																																			
Durata dell'affidabilità del funzionamento; resistenza a urti e vibrazioni	16.11, 16.12, 16.13	PASS																																																			
Durata dell'affidabilità del funzionamento; stabilità elettrica	16.14, 16.15	PASS																																																			
Durata del funzionamento; resistenza all'umidità	16.9, 16.10	PASS																																																			
Norma armonizzata EN54-4																																																					
Descrizione	Clausola/e	Esito																																																			
Prestazione dell'alimentatore	4, 5, 6	PASS																																																			
Affidabilità operativa	4, 5, 6, 7, 8	PASS																																																			
Durata dell'affidabilità del funzionamento, resistenza termica	9.5	PASS																																																			
Durata dell'affidabilità del funzionamento; resistenza a urti e vibrazioni	9.7, 9.8, 9.15	PASS																																																			
Durate dell'affidabilità del funzionamento; stabilità elettrica	Da 9.9 a 9.13	PASS																																																			
Durata del funzionamento; resistenza all'umidità	9.6, 9.14	PASS																																																			
10	La prestazione di cui ai punti 1 e 2 è conforme alla prestazione dichiarata di cui al punto 9. Si rilascia la presente di dichiarazione di prestazione sotto la responsabilità esclusiva del fabbricante di cui al punto 4.	Sant'Omero il 03/02/2017 Firmato a nome e per conto del fabbricante Fabrizio Sorbi Chairman																																																			

PROEL

PROEL S.p.A. (Worldwide Headquarters) Via alla Ruenia 37/43 - 64027 Sant'Omero (TE) - Italy • Tel. +39 0861 81241 - Fax +39 0861 887862
P.IVA e C.F. 00778590679 • Cap. Soc. Euro: 8.000.000,00 i.v. • R.E.A. 95381 Teramo • PEC: info@pec.proel.com
Società soggetta all'attività di direzione e coordinamento di Willpower Holding S.r.l., società con socio unico

PROEL

CE Marking

Proel Spa, Via Alla Ruenia 37/43 64027 S. Omero (TE) 02/02/2017 0051-CPR-0514
EN 54-4:1997+A1:2002+A2:2006 EN 54-16:2008 DOP n. 2016300A
CONTROL EQUIPMENT AND SIGNALING FOR VOCAL ALARM SYSTEMS. EQUIPPED OF INTEGRATED POWER SUPPLY. Model: AE300

Proel SpA maintains a policy of constant research and development, therefore we reserve the right to apply improvements to any existing equipment at any time without prior notice. REV: 136 / 19-18









PROEL S.p.A.

(World Headquarters - Factory)

Via alla Ruenia 37/43

64027 Sant'Omero (Te) – Italy

Tel: +39 0861 81241

Fax: +39 0861 887862

www.proel.com