

DH

PROFESSIONAL STAGE EQUIPMENT

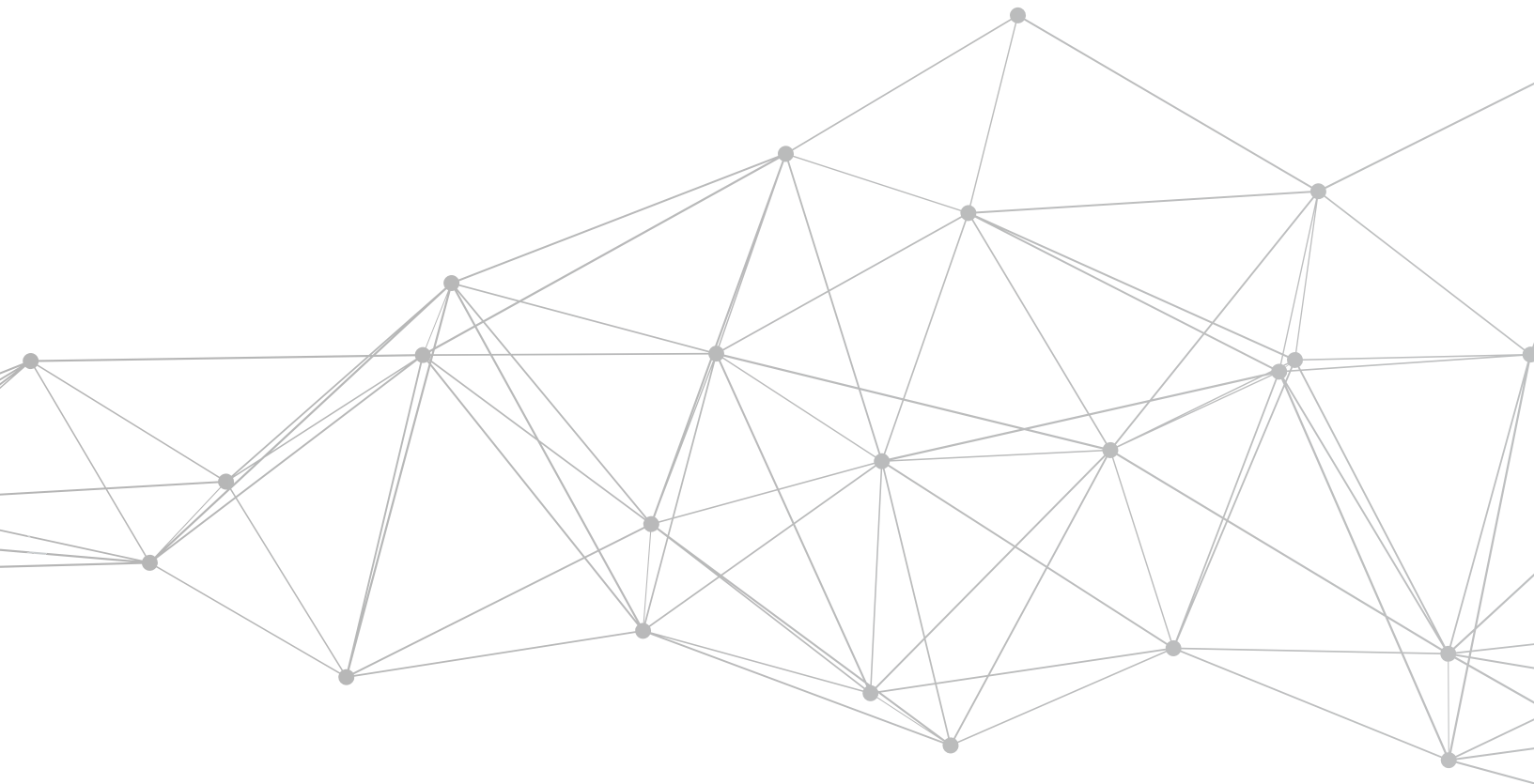





PROFESSIONAL STAGE EQUIPMENT

METAL SYSTEMS 4

MICROPHONE STANDS
KEYBOARD STANDS
SPEAKER STANDS
GUITAR AND MUSIC STANDS

PREMADE CABLES 14

ONEHERO SERIES
DH GOLD SERIES

CONNECTORS 23

ONEHERO SERIES
PROFESSIONAL ADAPTERS

SOFT BAGS 28

ARMOR SERIES
ARMOR ESSENTIAL SERIES
ARMOR WIND ORCHESTRA SERIES
MOON SERIES

STRAPS 42

PERFECT SERIES
SUPERB SERIES
SUPREME SERIES
WIND SERIES

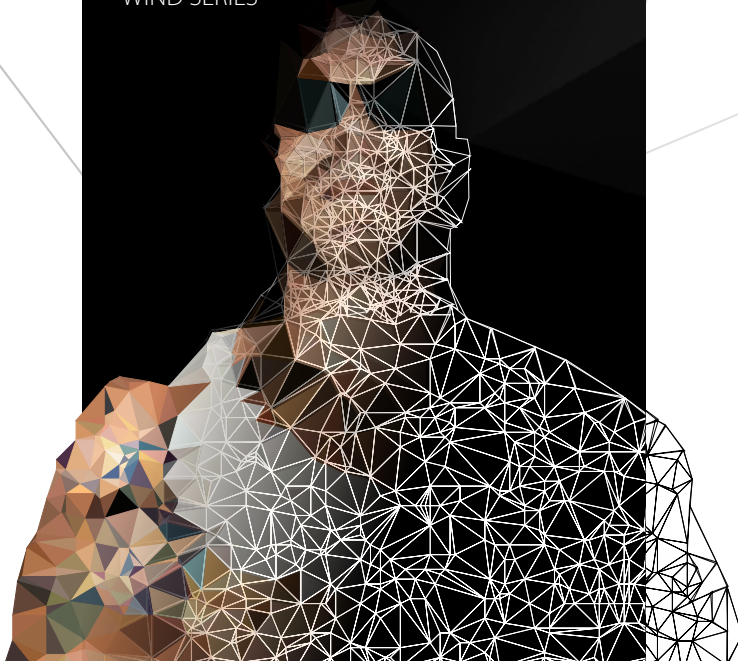

METAL SYSTEMS

La linea "Metal Systems" di METAL SYSTEMS DH si caratterizza per l'utilizzo di materiali di ultima generazione e l'attenta cura nei particolari, oltre all'indiscusso "Italian style" apprezzato e riconosciuto in tutto il mondo come sinonimo di qualità. Per l'ideazione e progettazione di questi prodotti sono stati interpellati i maggiori professionisti del panorama musicale mondiale. Un team di progettisti è riuscito a dare forma e sostanza a tutte le idee con l'ausilio di una continua ricerca e l'uso di tecnologie ad alto valore aggiunto. L'unione di tutti questi fattori ha permesso di raggiungere dei risultati sorprendenti per soddisfare le molteplici richieste espresse dal mercato nel panorama "on-stage".

The DH "Metal Systems" line is characterized by the use of the latest materials and careful attention to details, as well the undisputed "Italian style" appreciated and recognized worldwide for its quality. For the conception and design of these products were polled major professionals in the music world. A team of designers managed to give form and substance to all ideas with the help of continuous research and the use of high value-added technologies. The combination of all these factors has achieved amazing results to meet the multiple needs expressed by the market in the "on-stage" world.



New concept die-cast aluminum joint



Die-cast aluminum sleeve with "soft-grip"



New concept die-cast aluminum base

DHPMS40

- Asta microfonica professionale a giraffa, dotata di base tripode e snodo superiore in alluminio pressofuso, con tubi in acciaio di elevato spessore per un'ottima stabilità. Lo snodo superiore, di nuova concezione, presenta componenti ergonomici e di alta qualità che ne aumentano il frizionamento e permettono regolazioni accurate. E' inoltre provvista di manicotto centrale in alluminio pressofuso ricoperto in morbida gomma "soft-grip" che permette una presa salda per una semplice e sicura regolazione dell'altezza. Dotata di filettatura 3/8" con adattatore a passo 5/8" incluso. Disponibile in nero opaco.

- Professional boom microphone stand, featuring die-cast aluminum heavy duty tripod base and upper joint, with thick steel pipes for optimum stability. The new concept upper joint, presents ergonomic and high-quality components that increase the friction and allow accurate adjustments. It is also provided with a central die-cast aluminum sleeve covered with "soft-grip" rubber which allows a firm grip for a simple and safe height adjustment. Equipped with a 3/8" thread with 5/8" adapter included. Available in matte black.

Height	990 - 1690 mm (38.97" - 66.53")
Base diameter	710 mm (27.95")
Weight	2.90 kg (6.39 lbs)
Boom Length	800 mm (31.49")

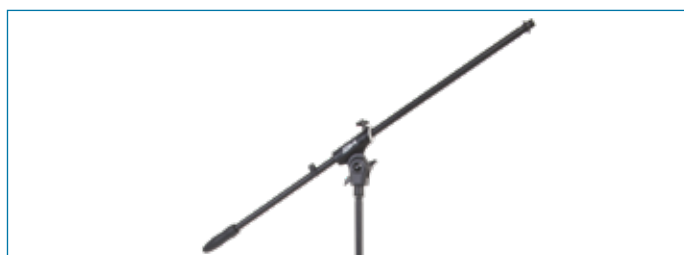

DHPMS50

- Asta microfonica professionale, con le stesse caratteristiche del modello DHPMS40, dotata di giraffa telescopica regolabile. Disponibile in nero opaco (DHPMS50) e cromata (DHPMS55).

- Professional microphone stand, featuring the same characteristics of the DHPMS40 model, with adjustable telescopic boom. Available in matte black (DHPMS50) and chrome finish (DHPMS55).

Height	990 - 1690 mm (38.97" - 66.53")
Base diameter	710 mm (27.95")
Weight	2.90 kg (6.39 lbs)
Boom Length	580 - 910 mm (22.83" - 35.82")

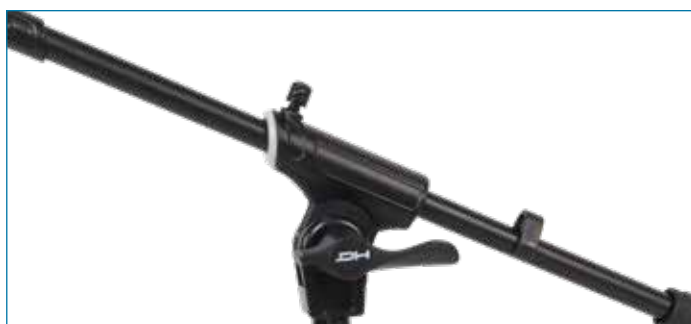

DHPMS55

- Asta microfonica professionale, con le stesse caratteristiche del modello DHPMS40, dotata di giraffa telescopica regolabile. Disponibile in nero opaco (DHPMS50) e cromata (DHPMS55).
- Professional microphone stand, featuring the same characteristics of the DHPMS40 model, with adjustable telescopic boom. Available in matte black (DHPMS50) and chrome finish (DHPMS55).

Height	990 - 1690 mm (38.97" - 66.53")
Base diameter	710 mm (27.95")
Weight	2.90 kg (6.39 lbs)
Boom Length	580 - 910 mm (22.83" - 35.82")



DHPMS60

- Asta microfonica professionale nana, con le stesse caratteristiche del modello DHPMS50, ma con dimensioni ridotte, come da tabella a fondo pagina. Disponibile in nero opaco.
- Professional low profile microphone stand, featuring the same characteristics of the DHPMS50 model, but with reduced dimensions. Available in matte black.

Height	400 - 770 mm (15.74" - 30.31")
Base diameter	600 mm (23.62")
Weight	2.30 kg (5.07 lbs)
Boom Length	580 - 910 mm (22.83" - 35.82")





DHPMS30

- Asta microfonica professionale dritta, dotata di base tripoide in alluminio pressofuso, con tubi in acciaio di elevato spessore per un'ottima stabilità. Provvista di manicotto centrale in alluminio pressofuso ricoperto in morbida gomma "soft-grip" che permette una presa salda per una semplice e sicura regolazione dell'altezza. Dotata di filettatura 3/8" con adattatore a passo 5/8" incluso. Disponibile in nero opaco.
- Professional straight microphone stand, featuring die-cast aluminum heavy duty tripod base with thick steel pipes for optimum stability. Provided with a central die-cast aluminum sleeve covered with "soft-grip" rubber which allows a firm grip for a simple and safe height adjustment. Equipped with a 3/8" thread with 5/8" adapter included. Available in matte black.

Height	880 - 1580 mm (34.50" - 62.20")
Base diameter	710 mm (27.95")
Weight	2.30 kg (5.07 lbs)

DHPMS70

- Braccio telescopico professionale, dotato di snodi in alluminio pressofuso, di nuova concezione, che presentano componenti ergonomici e di alta qualità che ne aumentano il frizionamento e permettono regolazioni accurate. Dotata di filettatura 3/8" con adattatore a passo 5/8" incluso. Può essere utilizzato sull'asta dritta DHPMS30 e sui supporti per tastiera serie DHKS10. Disponibile in nero opaco.
- Professional telescopic boom, equipped with new concept die-cast aluminum joints, present ergonomic and high-quality components that increase the friction and allow accurate adjustments. Equipped with a 3/8" thread with pitch 5/8" adapter included. It can be used with the straight DHPMS30 mic stand and with DHKS10 series keyboard stand. Available in matte black.

Weight	0.60 kg (1.32 lbs)
Boom Length	580 - 910 mm (22.83" - 35.82")



DHPMS10

- Asta microfonica professionale dritta con base in acciaio provvista del nuovo sistema ergonomico ONE-HAND che permette una semplice ed accurata regolazione dell'altezza. La base in acciaio a doppio livello, oltre ad offrire una elevata stabilità è dotata di anello circolare in gomma che evita qualsiasi vibrazione/feedback. Disponibile in nero opaco.
- Professional straight microphone stand with steel base provided with new ergonomic ONE-HAND system that allows simple and accurate height regulation. The two layer steel base ensures high stability and features a rubber ring to avoid any vibration/feedback. Available colour: matte black.

Height	1020 - 1680 mm (40.15" - 66.14")
Base diameter	250 mm (9.84")
Weight	4.20 kg (9.26 lbs)



DHKS40

• Supporto per tastiera a telaio singolo rinforzato, di robusta costruzione. Dotato di tubi di acciaio di alta qualità e giunzioni in alluminio che garantiscono la massima affidabilità. Dotato di un nuovo meccanismo di rilascio di facile utilizzo grazie all'ausilio di una leva che consente una configurazione rapida e una selezione di quattro diverse posizioni d'altezza. E' provvisto inoltre di tappi di gomma autolivellanti che permettono la regolazione su superfici irregolari e assicurano una maggiore stabilità. Fornito smontato per un più facile trasporto. Colori disponibili: nero opaco con inserti in grigio.

• *Single braced heavy duty and sturdy construction keyboard stand. Featuring high-grade steel tubing and die cast aluminium junctions that ensure maximum reliability. Provided with a new easy release mechanism at the touch of a lever that allows a quick set and selection one of four different height positions. Self-levelling rubber caps are supplied for adjustment on uneven surfaces and ensure extra stability. Supplied disassembled for easy shipping. Available colour: matt black with grey insert.*

Tier depth:	380 mm (14.96")
Weight:	4.24 kg (9.34 lbs)
Max loading weight	60 kg (132.27 lbs)
Folded dimension:	1050 x 135 x 510 mm (14.96" x 5.31" x 20.07")

DHKS40 / DHKS50 TECH INFO		
OPENED POSITION	WIDTH	HEIGHT
1	485 mm (19.09")	950 mm (37.40")
2	590 mm (23.22")	880 mm (34.64")
3	700 mm (27.55")	820 mm (32.28")
4	790 mm (31.10")	710 mm (27.95")



DHKS50

• Supporto per tastiera a telaio doppio, rinforzato, di robusta costruzione, particolarmente adatto per tastiere di grandi dimensioni, digitali e piano. Dotato di tubi di acciaio di alta qualità e giunzioni in alluminio che garantiscono la massima affidabilità. Dotato di un nuovo meccanismo di rilascio di facile utilizzo grazie all'ausilio di una leva che consente una configurazione rapida e una selezione di quattro diverse posizioni d'altezza. E' provvisto inoltre di tappi di gomma autolivellanti che permettono la regolazione su superfici irregolari e assicurano una maggiore stabilità. Fornito smontato per un più facile trasporto. Colori disponibili: nero opaco con inserti in grigio.

• *Double braced heavy duty and sturdy construction keyboard stand particularly suitable for larger keyboards and digital pianos. Featuring high-grade steel tubing and die cast aluminium junctions that ensure maximum reliability. Provided with a new easy release mechanism at the touch of a lever that allows a quick set and selection one of four different height positions. Self-levelling rubber caps are supplied for adjustment on uneven surfaces and ensure extra stability. Supplied disassembled for easy shipping. Available colour: matt black with grey insert.*

Tier depth	380 mm (14.96")
Weight	7.34 kg (16.18 lbs)
Max loading weight	90 kg (198.41 lbs)
Folded dimension	1050 x 135 x 510 mm (14.96" x 5.31" x 20.07")





DHKS52

- Supporto per tastiera a telaio doppio, rinforzato, di robusta costruzione, particolarmente adatto per tastiere di grandi dimensioni, digitali e piano. Dotato di tubi di acciaio di alta qualità e giunzioni in alluminio che garantiscono la massima affidabilità. Dotato di un nuovo meccanismo di rilascio di facile utilizzo grazie all'ausilio di una leva che consente una configurazione rapida e una selezione di quattro diverse posizioni d'altezza. È provvisto inoltre di tappi di gomma autolivellanti che permettono la regolazione su superfici irregolari e assicurano una maggiore stabilità. Fornito smontato per un più facile trasporto. Colori disponibili: nero opaco con inserti in grigio.
- *Double braced heavy duty and sturdy construction keyboard stand particularly suitable for larger keyboards and digital pianos. Featuring high-grade steel tubing and die cast aluminium junctions that ensure maximum reliability. Provided with a new easy release mechanism at the touch of a lever that allows a quick set and selection one of four different height positions. Self-levelling rubber caps are supplied for adjustment on uneven surfaces and ensure extra stability. Supplied disassembled for easy shipping. Available colour: matt black with grey insert.*

Tier depth	380 mm (14.96")
Weight	10.0 kg (22.40 lbs)
Max loading weight	90 kg (198.41 lbs)
Folded dimension	1050 x 135 x 510 mm (14.96" x 5.31" x 20.07")

DHKS52 TECH INFO			
OPENED POSITION	WIDTH	HEIGHT	2 nd TIER HEIGHT
1	485 mm (19.09")	950 mm (37.40")	1227 mm (48.30")
2	590 mm (23.22")	880 mm (34.64")	-
3	700 mm (27.55")	820 mm (32.28")	-
4	790 mm (31.10")	710 mm (27.95")	993 mm (39.09")



DHKS10BK - DHKS10SL

- Supporto a colonna per tastiere dotato di doppi bracci regolabili in altezza. Realizzato in alluminio estruso e acciaio tubolare, materiali che assicurano la massima affidabilità. I gambi rientrano nella struttura ed i bracci si ripiegano per permettere un facile trasporto con la pratica borsa in dotazione.
- *Column style keyboard stand, now with additional 3rd leg enhanced stability. Constructed from robust steel tubing and extruded aluminium profile, this roadworthy stand is built with maximum reliability in mind. Other features include double height adjustment arms and legs that retract inside the centre column allowing easy transportation inside the included carrying bag.*

Height	1040 mm (40.94")
Tiers length	lower 440 mm (17.32") – upper 390 mm (15.35")
Weight	7.50 kg (16.53 lbs)
Maximum load	lower tier 25 kg (55.11 lbs) – upper tier 20 kg (44.09 lbs)*
Folded dimensions	1200 mm x 150 mm x 150 mm (47.24" x 5.90" x 5.90")

* Load capacity is 25 kg lower tier and 20 kg for the upper tier when the legs are levelled and positioned firmly on the surface.

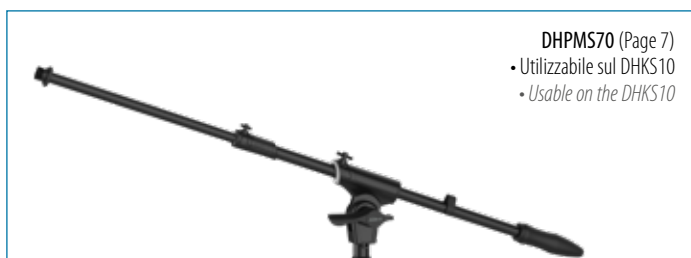

- DHPS70 (Page 7)
- Utilizzabile sul DHKS10
- Usabile on the DHKS10

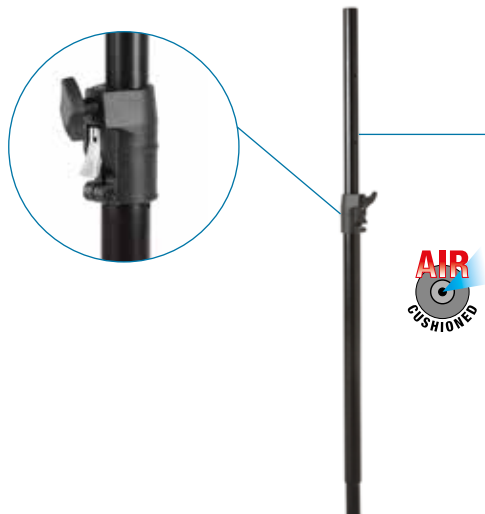

DHSS40

- Distanziale professionale regolabile per satellite – subwoofer, realizzato in acciaio tubolare e parti in alluminio. Dotato del sistema di sicurezza con pin automatico e del collaudato dispositivo ad aria "AIR-CUSHIONED" per garantire massima flessibilità, velocità e facilità nelle operazioni di regolazione. Colore nero opaco.
- Professional height adjustable satellite – subwoofer spacer constructed from robust steel tubes and aluminum parts. Equipped with the security system with automatic pin and the well known "AIR-CUSHIONED" system, to ensure maximum flexibility, fast and easy adjustment. Available in matt black.

Adjustable Height:	880 – 1320 mm (34.64" – 51.96")
Weight:	1 kg (2.20 lbs)
Max load capacity:	40 kg (88.18 lbs)
Ø Termination tube:	35 mm (1.37")

DHSS50KIT

• Coppia di supporti professionali per diffusori acustici, realizzati in acciaio tubolare e parti in alluminio. Dotati del sistema di sicurezza con pin automatico e del collaudato dispositivo ad aria "AIR-CUSHIONED" per garantire massima flessibilità, velocità e facilità nelle operazioni di regolazione. I supporti sono inoltre muniti di collare in pressofusione per garantire una maggiore tenuta dello snodo dei gambi. Pratica borsa in Nylon 210D per un agevole trasporto. Colore nero opaco.

• Pair of professional loudspeakers stands, made of tubular steel and aluminum parts. Equipped with the security system with automatic pin and the well known "AIR-CUSHIONED" system to ensure maximum flexibility, speed and ease in adjustment operations. The stands are also equipped with casting collar in order to ensure a better tightness of the legs joint. Practical Nylon 210D bag for easy transport included. Available in matt black.

Adjustable Height:	1390 - 2000 mm (54.72 - 78.74")
Weight:	3.90 kg (8.59 lbs)
Max load capacity:	50 kg (110.22 lbs)
Ø Base:	1200 mm (47.24")
Ø Upper tube end:	35 mm (1.37")



DHSS60

• Nuovo e robusto stativo professionale per diffusori acustici, realizzato in acciaio tubolare e parti in alluminio pressofuso. Dotato di un esclusivo meccanismo automatico di elevazione per mezzo di un sistema interno ad aria compressa, che aiuta a sollevare il diffusore acustico senza sforzo. Altezza massima 2000 mm. Finitura nero opaco

• New heavy-duty professional loudspeakers stand, made of tubular steel and die cast aluminum parts. Featuring exclusive automatic elevation mechanism powered by an internal system of compressed air, which helps to raise the loudspeaker without effort. Maximum height 2000 mm. Matt black finishing.

Adjustable Height:	1280 - 2000 mm (78.74 - 78.74")
Weight:	5.00 kg (11.02 lbs)
Max load capacity:	50 kg (110.22 lbs)
Ø Upper tube end:	35 mm (1.37")



DHSS20

- Stativo professionale per diffusori acustici, realizzato in acciaio tubolare e parti in alluminio pressofuso. Dotato di meccanismo di elevazione con freno meccanico per garantire la massima stabilità al carico e la facilità di montaggio. Altezza massima 2200 mm. Colore nero opaco (tubo superiore zincato).
- Professional heighth adjustable loudspeaker stand constructed from robust steel tubes and die-cast aluminum. The lifting mechanism features a mechanical brake to guarantee maximum load stability and ease of set up. Maximum height 2200 mm. Matte black colour (upper zinc tube).

Adjustable Height:	1400 - 2200 mm (55.11 - 86.61")
Weight:	8.50 kg (18.73 lbs)
Max load capacity:	60 kg (132.27 lbs)
Ø Base:	1300 mm (51.18")
Ø Upper tube end:	35 mm (1.37")



DHSS30

Stativo professionale per diffusori acustici / sistemi luce, realizzato in acciaio tubolare e parti in alluminio pressofuso. Dotato di meccanismo di elevazione con freno meccanico per garantire la massima stabilità al carico e la facilità di montaggio. Altezza massima 3200 mm. Colore nero opaco (tubo superiore zincato).

Professional heighth adjustable loudspeaker / lighting stand constructed from robust steel tubes and die-cast aluminum. The lifting mechanism features a mechanical brake to guarantee maximum load stability and ease of set up. Maximum height 3200 mm. Matte black colour (upper zinc tube).

Adjustable Height:	1850 - 3200 mm (72.83 - 125.98")
Weight:	9.50 kg (20.94 lbs)
Max load capacity:	60 kg (132.27 lbs)
Ø Base:	1300 mm (51.18")
Ø Upper tube end:	35 mm (1.37")

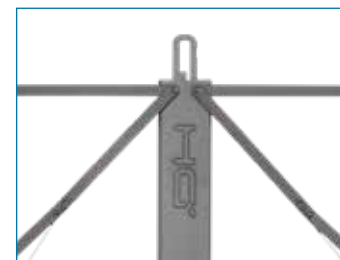

DHMSS10

• Nuovo leggìo professionale ultra leggero a tre sezioni completamente pieghevole. Costruito in acciaio, con base dei gambi, snodi intermedi e blocco superiore in alluminio pressofuso, che garantiscono un'elevata stabilità. Tutte le parti interne di scorrimento sono realizzate in nylon di alta qualità che permettono regolazioni semplici ed accurate. Fornito di pratica borsa in nylon per un agevole trasporto. Colore nero.

• New ultra-light professional music stand with three fully collapsible sections. Built in steel, with TRIPOD base, intermediate joints and upper block in die-cast aluminum, which guarantee a high stability. All the inner sliding parts are made of high quality nylon that allow simple and accurate adjustments. Supplied with nylon carrying bag included for easy transport. Black colour.

Adjustable height 680 - 1250 mm (26.77" - 49.21")

Weight 1.60 Kg (3.52 lbs)

Ø Base 680 mm (26.77")

Music sheet dimensions W 440 x H 240 mm (17.32" - 9.44")



DHMSS30

Nuovo leggìo professionale con tavola appoggia spartiti regolabile e base tripoide. Progettato per sostenere carichi notevoli, è dotato di tutti gli snodi realizzati in alluminio pressofuso con parti di scorrimento in nylon, che oltre a garantire regolazioni precise e veloci ne aumentano la stabilità e la durezza nel tempo. Il manicotto centrale, anche esso in alluminio, è ricoperto in morbida e resistente gomma "soft-grip" per una presa salda e sicura. Fornito di pratica borsa in nylon per un agevole trasporto. Disponibile in nero opaco.

New professional music stand with adjustable metal upper plate and tripod base. Designed to support heavy weight, it is equipped with all die cast aluminum joints with inner nylon parts, which in addition to ensuring precise and quick adjustments, will increase the stability and durability over time. The central sleeve, also made of die cast aluminum, is covered with "soft-grip" durable rubber for a firm and secure grip. Supplied with nylon carrying bag for easy transport. Available in matt black.

Adjustable height 780 - 1250 mm (30.70" - 49.21")

Weight 2.60 Kg (5.73 lbs)

Ø Base 600 mm (23.62")

Music sheet dimensions W 500 x H 340 mm (19.68" - 13.38")

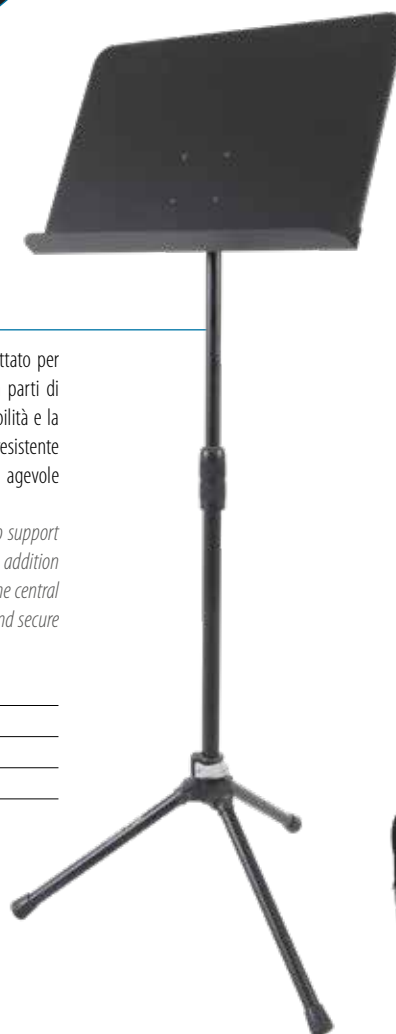



DHMS75

- Leggio professionale per spartiti, dotato del nuovo sistema "one hand" per una rapida e facile regolazione dell' altezza. Provvisto di base triangolare in acciaio per la massima stabilità. Colori disponibili: nero opaco.
- Professional sheet music stand with one hand quick release adjustment system that enables smooth. Heavy triangular cast iron base for maximum stability. Available color: matt black with grey insert.

Adjustable height	1060 - 1600 mm (41.73" - 62.99")
Weight	2.720 Kg (5.99 lbs)
Ø Base	500 mm (19.68")
Music sheet dimensions	W 510 x H 330 mm (20.07" - 12.99")

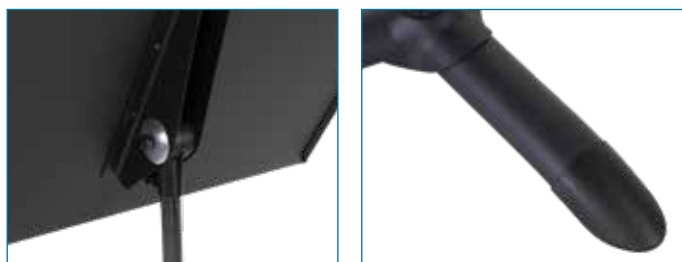

DHPGS10

• Nuova supporto universale da terra per chitarra, realizzato in acciaio e alluminio. Regolabile in altezza per mezzo del manico in alluminio pressofuso ricoperto in gomma "soft-grip". Dotato del sistema di chiusura AUTO-LOCK, che permette il blocco automatico della chitarra semplicemente appoggiandola sul gancio predisposto. Tutte le parti a contatto con il prodotto sono rivestite in morbida gomma ed EVA per proteggere la finitura dello strumento. Completamente ripiegabile per un facile trasporto. Colore nero opaco.

• New universal floor standing stand for guitar, made of steel and aluminum. Adjustable height by means of the "soft-grip" rubber covered die-cast aluminum clutch. Equipped with the AUTO-LOCK closing system, which allows automatic locking of the guitar simply resting it on the dedicated hook. All contact parts are covered with soft rubber and EVA to protect the instrument's finish. Fully foldable for easy transport. Matt black color.

Height	670 - 1290 mm (26.37" - 50.78")
Base diameter	600 mm (23.6")
Net weight	1.45 Kg (3.19 lbs)
Maximum loading weight	15 Kg (33.07 lbs)



PREMADE CABLES

ONEHERO

ONEHERO è una nuova serie di cavi assemblati e connettori dal design unico ed esclusivo, frutto della ricerca dell'R&D di PROEL che ancora una volta, ha scelto di investire risorse nella progettazione di strumenti innovativi e professionali dedicati alle crescenti richieste del mercato. I cavi assemblati si distinguono per i materiali utilizzati, di ultima generazione ed altissima qualità come rame rosso OHFC (Oxygen Free High Conductivity) lavorato in assenza di ossigeno, che migliora sensibilmente il trasferimento elettrico del segnale, rendendolo più trasparente, puro, limpido, fluido e dinamico.

ONEHERO is a new series of premade cables and connectors with a unique and exclusive design, the result of PROEL R & D that once again, chose to invest resources in the design of innovative and professional tools dedicated to the growing market demands. The premed cables are distinguished by the materials used, the latest generation and very high quality as red copper OHFC (Oxygen Free High Conductivity) worked in the absence of oxygen, which significantly improves the electric signal transfer, making it more transparent, pure, clear, fluid and dynamic.





DHS100

INSTRUMENT CABLE

Ø 6.3 mm MONO JACK PLUG – Ø 6.3 mm MONO JACK PLUG

- Guaina esterna: Ø 7.0 mm PVC ad alta flessibilità
- Conduttore: rame rosso 1x0,50 mm²
- 1° schermo: PVC DH ad alta conduttività
- 2° schermo: a treccia di rame stagnato - 128x0,10 mm
- Overall jacket: Ø 7.0 mm high grade flexible PVC
- Conductor: 1x0,50 mm² bare copper
- 1st shield: DH high conductivity PVC
- 2nd shield: dense braided tinned copper wire - 128x0,10 mm

CODE	LENGTH
DHS100LU1	1 mt (3,28 ft)
DHS100LU2	2 mt (6,56 ft)
DHS100LU3	3 mt (9,84 ft)
DHS100LU5	5 mt (16,40 ft)
DHS100LU6	6 mt (19,69 ft)
DHS100LU10	10 mt (32,81 ft)



DHS120

INSTRUMENT CABLE

Ø 6.3 mm MONO JACK PLUG – Ø 6.3 mm RIGHT ANGLE MONO JACK PLUG

- Guaina esterna: Ø 7.0 mm PVC ad alta flessibilità
- Conduttore: 1x0,50 mm²
- 1° schermo: PVC DH ad alta conduttività
- 2° schermo: a treccia di rame stagnato - 128x0,10 mm
- Overall jacket: Ø 7.0 mm high grade flexible PVC
- Conductor: 1x0,50 mm²
- 1st shield: DH high conductivity PVC
- 2nd shield: dense braided tinned copper wire - 128x0,10 mm

CODE	LENGTH
DHS120LU3	3 mt (9,84 ft)
DHS120LU5	5 mt (16,40 ft)
DHS120LU6	6 mt (19,69 ft)



DHS200

UNBALANCED CABLE

Ø 6.3 mm MONO JACK PLUG – 3P FEMALE XLR

- Guaina esterna: Ø 7.0 mm PVC ad alta flessibilità
- Conduttori: rame rosso 2x0,34 mm²
- 1° schermo: LLPDE
- 2° schermo: a treccia di rame stagnato - 128x0,10 mm
- Overall jacket: Ø 7.0 mm high grade flexible PVC
- Conductors: 2x0,34 mm² bare copper
- 1st shield: LLPDE
- 2nd shield: dense braided tinned copper wire - 128x0,10 mm

CODE	LENGTH
DHS200LU3	3 mt (9,84 ft)
DHS200LU5	5 mt (16,40 ft)
DHS200LU10	10 mt (32,81 ft)



DHS220

UNBALANCED CABLE

Ø 6.3 mm MONO JACK PLUG – 3P MALE XLR

- Guaina esterna: Ø 7.0 mm PVC ad alta flessibilità
- Conduttori: rame rosso 2x0,34 mm²
- 1° schermo: LLPDE
- 2° schermo: a treccia di rame stagnato - 128x0,10 mm
- Overall jacket: Ø 7.0 mm high grade flexible PVC
- Conductors: 2x0,34 mm² bare copper
- 1st shield: LLPDE
- 2nd shield: dense braided tinned copper wire - 128x0,10 mm

CODE	LENGTH
DHS220LU1	1 mt (3,28 ft)
DHS220LU3	3 mt (9,84 ft)
DHS220LU5	5 mt (16,40 ft)
DHS220LU10	10 mt (32,81 ft)



DHS140

BALANCED CABLE

Ø 6.3 mm STEREO JACK PLUG – Ø 6.3 mm STEREO JACK PLUG

- Guaina esterna: Ø 7.0 mm PVC ad alta flessibilità
- Conduttori: rame rosso 2x0,34 mm²
- 1° schermo: PVC DH
- 2° schermo: a treccia di rame stagnato - 128x0,10 mm
- Overall jacket: Ø 7.0 mm high grade flexible PVC
- Conductors: 2x0,34 mm² bare copper
- 1st shield: DH high grade PVC
- 2nd shield: dense braided tinned copper wire - 128x0,10 mm

CODE	LENGTH
DHS140LU1	1 mt (3,28 ft)
DHS140LU2	2 mt (6,56 ft)
DHS140LU3	3 mt (9,84 ft)
DHS140LU5	5 mt (16,40 ft)



DHS210

BALANCED CABLE

Ø 6.3 mm STEREO JACK PLUG – 3P FEMALE XLR

- Guaina esterna: Ø 7.0 mm PVC ad alta flessibilità
- Conduttori: rame rosso 2x0,34 mm²
- 1° schermo: PVC DH
- 2° schermo: a treccia di rame stagnato - 128x0,10 mm
- Overall jacket: Ø 7.0 mm high grade flexible PVC
- Conductors: 2x0,34 mm² bare copper
- 1st shield: DH high grade PVC
- 2nd shield: dense braided tinned copper wire - 128x0,10 mm

CODE	LENGTH
DHS210LU1	1 mt (3,28 ft)
DHS210LU2	2 mt (6,56 ft)
DHS210LU3	3 mt (9,84 ft)
DHS210LU5	5 mt (16,40 ft)



DHS230

BALANCED CABLE

Ø 6.3 mm STEREO JACK PLUG – 3P MALE XLR

- Guaina esterna: Ø 7.0 mm PVC ad alta flessibilità
- Conduttori: rame rosso 2x0,34 mm²
- 1° schermo: PVC DH
- 2° schermo: a treccia di rame stagnato - 128x0,10 mm
- Overall jacket: Ø 7.0 mm high grade flexible PVC
- Conductors: 2x0,34 mm² bare copper
- 1st shield: DH high grade PVC
- 2nd shield: dense braided tinned copper wire - 128x0,10 mm

CODE	LENGTH
DHS230LU05	0,5 mt (1,64 ft)
DHS230LU1	1 mt (3,28 ft)
DHS230LU2	2 mt (6,56 ft)
DHS230LU3	3 mt (9,84 ft)
DHS230LU5	5 mt (16,40 ft)
DHS230LU10	10 mt (32,81 ft)



DHS240

BALANCED CABLE

3P FEMALE XLR – 3P MALE XLR

- Guaina esterna: Ø 7.0 mm PVC ad alta flessibilità
- Conduttori: rame rosso 2x0,34 mm²
- 1° schermo: PVC DH
- 2° schermo: a treccia di rame stagnato - 128x0,10 mm
- Overall jacket: Ø 7.0 mm high grade flexible PVC
- Conductors: 2x0,34 mm² bare copper
- 1st shield: DH high grade PVC
- 2nd shield: dense braided tinned copper wire - 128x0,10 mm

CODE	LENGTH
DHS240LU05	0,5 mt (1,64 ft)
DHS240LU1	1 mt (3,28 ft)
DHS240LU2	2 mt (6,56 ft)
DHS240LU3	3 mt (9,84 ft)
DHS240LU5	5 mt (16,40 ft)
DHS240LU6	6 mt (19,69 ft)
DHS230LU10	10 mt (32,81 ft)



DHS505

ADAPTER CABLE

2 X RCA - 2 X RCA

- Guaina esterna: 2xØ 5.0 mm PVC ad alta flessibilità
- Conduttori: rame rosso 2x0,22 mm²
- 1° schermo: LLDPE
- 2° schermo: a spirale di rame rosso
- Overall jacket: Ø 2xØ 5.0 mm high grade flexible PVC
- Conductors: 2x0,22 mm² bare copper
- 1st shield: LLDPE
- 2nd shield: dense spiral bare copper wire

CODE	LENGTH
DHS505LU18	1,8 mt (5,91 ft)
DHS505LU3	3 mt (9,84 ft)



DHS520

INSERT CABLE

3,5 STEREO JACK PLUG - 2 X RCA

- Guaina esterna: Ø 6.5 mm - Ø 5.0 mm PVC ad alta flessibilità
- Conduttori: rame rosso 0,22 mm²
- 1° schermo: LLDPE
- 2° schermo: a spirale di rame rosso
- Overall jacket: Ø 6.5 mm - Ø 5.0 mm high grade flexible PVC
- Conductors: 0,22 mm² bare copper
- 1st shield: LLDPE
- 2nd shield: dense spiral bare copper wire

CODE	LENGTH
DHS520LU18	1,8 mt (5,91 ft)
DHS520LU3	3 mt (9,84 ft)
DHS520LU5	5 mt (16,40 ft)



DHS530

INSERT CABLE

6,3 STEREO JACK PLUG - 2 X RCA

- Guaina esterna: Ø 6.5 mm - Ø 5.0 mm PVC ad alta flessibilità
- Conduttori: rame rosso 0,22 mm²
- 1° schermo: LLDPE
- 2° schermo: a spirale di rame rosso
- Overall jacket: Ø 6.5 mm - Ø 5.0 mm high grade flexible PVC
- Conductors: 0,22 mm² bare copper
- 1st shield: LLDPE
- 2nd shield: dense spiral bare copper wire

CODE	LENGTH
DHS530LU18	1,8 mt (5,91 ft)
DHS530LU3	3 mt (9,84 ft)



DHS535

ADAPTER CABLE

2 X 6,3 MONO JACK PLUG - 2 X RCA

- Guaina esterna: 2xØ 5.0 mm PVC ad alta flessibilità
- Conduttori: rame rosso 2x0,22 mm²
- 1° schermo: LLDPE
- 2° schermo: a spirale di rame rosso
- Overall jacket: 2xØ 5.0 mm high grade flexible PVC
- Conductors: 2x0,22 mm² bare copper
- 1st shield: LLDPE
- 2nd shield: dense spiral bare copper wire

CODE	LENGTH
DHS535LU18	1,8 mt (5,91 ft)
DHS535LU3	3 mt (9,84 ft)
DHS535LU5	5 mt (16,40 ft)



DHS540

INSERT CABLE

6,3 STEREO JACK PLUG - 2 X 6,3 MONO JACK PLUG

- Guaina esterna: Ø 6.5 mm - Ø 5.0 mm PVC ad alta flessibilità
- Conduttori: rame rosso 0,22 mm²
- 1° schermo: LLDPE
- 2° schermo: a spirale di rame rosso
- Overall jacket: Ø 6.5 mm - Ø 5.0 mm high grade flexible PVC
- Conductors: 0,22 mm² bare copper
- 1st shield: LLDPE
- 2nd shield: dense spiral bare copper wire

CODE	LENGTH
DHS540LU18	1,8mt (5,91 ft)
DHS540LU3	3 mt (9,84 ft)
DHS540LU5	5 mt (16,40 ft)



DHS545

INSERT CABLE

3,5 STEREO JACK PLUG - 2 X 6,3 MONO JACK PLUG

- Guaina esterna: Ø 6.5 mm - Ø 5.0 mm PVC ad alta flessibilità
- Conduttori: rame rosso 0,22 mm²
- 1° schermo: LLDPE
- 2° schermo: a spirale di rame rosso
- Overall jacket: Ø 6.5 mm - Ø 5.0 mm high grade flexible PVC
- Conductors: 0,22 mm² bare copper
- 1st shield: LLDPE
- 2nd shield: dense spiral bare copper wire

CODE	LENGTH
DHS545LU18	1,8mt (5,91 ft)
DHS545LU3	3 mt (9,84 ft)
DHS545LU5	5 mt (16,40 ft)



DHS550

BALANCED CABLE

3,5 STEREO JACK PLUG - 3,5 STEREO JACK PLUG

- Guaina esterna: Ø 5.0 mm PVC ad alta flessibilità
- Conduttori: rame rosso 2x0,22 mm²
- 1° schermo: LLDPE
- 2° schermo: a spirale di rame rosso
- Overall jacket: Ø 5.0 mm high grade flexible PVC
- Conductors: 2x0,22 mm² bare copper
- 1st shield: LLDPE
- 2nd shield: dense spiral bare copper wire

CODE	LENGTH
DHS550LU18	1,8mt (5,91 ft)
DHS550LU3	3 mt (9,84 ft)



DHS560

ADAPTER BALANCED CABLE

3,5 STEREO JACK PLUG - 6,3 STEREO JACK PLUG

- Guaina esterna: Ø 5.0 mm PVC ad alta flessibilità
- Conduttori: rame rosso 2x0,22 mm²
- 1° schermo: LLDPE
- 2° schermo: a spirale di rame rosso
- Overall jacket: Ø 5.0 mm high grade flexible PVC
- Conductors: 2x0,22 mm² bare copper
- 1st shield: LLDPE
- 2nd shield: dense spiral bare copper wire

CODE	LENGTH
DHS560LU18	1,8mt (5,91 ft)
DHS560LU3	3 mt (9,84 ft)



DHS595

STEREO CABLE

3,5 STEREO JACK PLUG - 2 X 3P MALE XLR

- Guaina esterna: Ø 6.5 mm - Ø 5.0 mm PVC ad alta flessibilità
- Conduttori: rame rosso 0,22 mm²
- 1° schermo: LLDPE
- 2° schermo: a spirale di rame rosso
- Overall jacket: Ø 6.5 mm - Ø 5.0 mm high grade flexible PVC
- Conductors: 0,22 mm² bare copper
- 1st shield: LLDPE
- 2nd shield: dense spiral bare copper wire

CODE	LENGTH
DHS595LU18	1,8mt (5,91 ft)
DHS595LU3	3 mt (9,84 ft)
DHS595LU5	5 mt (16,40 ft)



DHS600

INSTRUMENT CABLE

2 X Ø 6.3 mm RIGHT ANGLE MONO JACK PLUG

- Guaina esterna: Ø 7.0 mm PVC ad alta flessibilità
- Conduttore: 1x0,50 mm²
- 1° schermo: PVC DH ad alta conduttività
- 2° schermo: a treccia di rame stagnato - 128x0,10 mm
- Overall jacket: Ø 7.0 mm high grade flexible PVC
- Conductor: 1x0,50 mm²
- 1st shield: DH high conductivity PVC
- 2nd shield: dense braided tinned copper wire - 128x0,10 mm

CODE	LENGTH
DHS600LU015	0,15 mt (5,90 ft)
DHS600LU03	0,3 mt (11,81 ft)

PREMADE CABLES

DH
GOLD

La linea Gold della serie DH, si è sempre posizionata ai vertici del mercato in quanto a caratteristiche tecniche, affidabilità, e durevolezza nel tempo. Con la tradizione di PROEL e gli elevati standard di efficienza e di qualità dei prodotti, abbiamo raggiunto obiettivi importanti in fatto di competitività e il rispetto da parte di professionisti del settore. Le peculiarità fondamentali che contraddistinguono questa serie e che hanno permesso di ottenere elevatissime performance sono il controllo costante della qualità, la scelta dei materiali e la loro lavorazione. Per i cavi DHG PROEL ha scelto materiali indiscutibili, geometrie particolari, cura del design e controllo costante della qualità riuscendo a rispettare la fedeltà e a garantire l'integrità del segnale.

The well-known DH Gold series, has always been at the top of the market due to its technical features, reaching a considerable competitiveness and the esteem from the professionals of the field. The tradition of Proel together with constant quality control, choice of materials and production methods are the key features that identify the series and that have led it to very high performances.

PROEL has chosen for its DHG cables a selection of pure materials, distinctive patterns as well as unprecedented product design's accuracy and constant quality monitoring, all elements that have allowed us to follow closely the signal integrity.





DHG100

INSTRUMENT CABLE

Ø 6.3 mm MONO JACK PLUG – Ø 6.3 mm MONO JACK PLUG

- Guaina esterna: Ø 6.5 mm PVC ad alta flessibilità
- 1° schermo: PVC DH ad alta conduttività
- 2° schermo: a treccia di rame rosso
- Overall jacket: Ø 6.5 mm high grade flexible PVC
- 1st shield: DH high conductivity PVC
- 2nd shield: dense braided red copper wire

CODE	LENGTH
DHG100LU05	0,5 mt (1,64 ft)
DHG100LU1	1 mt (3,28 ft)
DHG100LU2	2 mt (6,56 ft)
DHG100LU3	3 mt (9,84 ft)
DHG100LU5	5 mt (16,40 ft)
DHG100LU6	6 mt (19,69 ft)
DHG100LU10	10 mt (32,81 ft)



DHG120

INSTRUMENT CABLE

Ø 6.3 mm MONO JACK PLUG – Ø 6.3 mm RIGHT ANGLE MONO JACK PLUG

- Guaina esterna: Ø 6.5 mm PVC ad alta flessibilità
- 1° schermo: PVC DH ad alta conduttività
- 2° schermo: a treccia di rame rosso
- Overall jacket: Ø 6.5 mm high grade flexible PVC
- 1st shield: DH high conductivity PVC
- 2nd shield: dense braided red copper wire

CODE	LENGTH
DHG120LU3	3 mt (9,84 ft)
DHG120LU5	5 mt (16,40 ft)
DHG120LU6	6 mt (19,69 ft)



DHG200

UNBALANCED CABLE

Ø 6.3 mm MONO JACK PLUG – 3P FEMALE XLR

- Guaina esterna: Ø 6.5 mm PVC ad alta flessibilità
- 1° schermo: PVC DH
- 2° schermo: a treccia di rame stagnato
- Overall jacket: Ø 6.5 mm high grade flexible PVC
- 1st shield: DH high grade PVC
- 2nd shield: dense braided tinned copper wire

CODE	LENGTH
DHG200LU3	3 mt (9,84 ft)
DHG200LU5	5 mt (16,40 ft)
DHG200LU10	10 mt (32,81 ft)



DHG220

UNBALANCED CABLE

Ø 6.3 mm MONO JACK PLUG – 3P MALE XLR

- Guaina esterna: Ø 6.5 mm PVC ad alta flessibilità
- 1° schermo: PVC DH
- 2° schermo: a treccia di rame stagnato
- Overall jacket: Ø 6.5 mm high grade flexible PVC
- 1st shield: DH high grade PVC
- 2nd shield: dense braided tinned copper wire

CODE	LENGTH
DHG220LU1	1 mt (3,28 ft)
DHG220LU3	3 mt (9,84 ft)
DHG220LU5	5 mt (16,40 ft)
DHG220LU10	10 mt (32,81 ft)



DHG140

BALANCED CABLE

Ø 6.3 mm STEREO JACK PLUG – Ø 6.3 mm STEREO JACK PLUG

- Guaina esterna: Ø 6.5 mm PVC ad alta flessibilità
- 1° schermo: PVC DH
- 2° schermo: a treccia di rame stagnato
- Overall jacket: Ø 6.5 mm high grade flexible PVC
- 1st shield: DH high grade PVC
- 2nd shield: dense braided tinned copper wire

CODE	LENGTH
DHG140LU1	1 mt (3,28 ft)
DHG140LU2	2 mt (6,56 ft)
DHG140LU3	3 mt (9,84 ft)
DHG140LU5	5 mt (16,40 ft)



DHG210

BALANCED CABLE

Ø 6.3 mm STEREO JACK PLUG – 3P FEMALE XLR

- Guaina esterna: Ø 6.5 mm PVC ad alta flessibilità
- 1° schermo: PVC DH
- 2° schermo: a treccia di rame stagnato
- Overall jacket: Ø 6.5 mm high grade flexible PVC
- 1st shield: DH high grade PVC
- 2nd shield: dense braided tinned copper wire

CODE	LENGTH
DHG210LU1	1 mt (3,28 ft)
DHG210LU2	2 mt (6,56 ft)
DHG210LU3	3 mt (9,84 ft)
DHG210LU5	5 mt (16,40 ft)



DHG230

BALANCED CABLE

Ø 6.3 mm STEREO JACK PLUG – 3P MALE XLR

- Guaina esterna: Ø 6.5 mm PVC ad alta flessibilità
- 1° schermo: PVC DH
- 2° schermo: a treccia di rame stagnato
- Overall jacket: Ø 6.5 mm high grade flexible PVC
- 1st shield: DH high grade PVC
- 2nd shield: dense braided tinned copper wire

CODE	LENGTH
DHG230LU05	0,5 mt (1,64 ft)
DHG230LU1	1 mt (3,28 ft)
DHG230LU2	2 mt (6,56 ft)
DHG230LU3	3 mt (9,84 ft)
DHG230LU5	5 mt (16,40 ft)
DHG230LU10	10 mt (32,81 ft)



DHG240

BALANCED CABLE

3P FEMALE XLR – 3P MALE XLR

- Guaina esterna: Ø 6.5 mm PVC ad alta flessibilità
- 1° schermo: PVC DH
- 2° schermo: a treccia di rame stagnato
- Overall jacket: Ø 6.5 mm high grade flexible PVC
- 1st shield: DH high grade PVC
- 2nd shield: dense braided tinned copper wire

CODE	LENGTH
DHG240LU05	0,5 mt (1,64 ft)
DHG240LU1	1 mt (3,28 ft)
DHG240LU2	2 mt (6,56 ft)
DHG240LU3	3 mt (9,84 ft)
DHG240LU5	5 mt (16,40 ft)
DHG240LU6	6 mt (19,69 ft)
DHG230LU10	10 mt (32,81 ft)



DHG505

ADAPTER CABLE

2 X RCA - 2 X RCA

- Guaina esterna: 2 * Ø 6.0 mm PVC ad alta flessibilità
- 1° schermo: Foglio in alluminio
- 2° schermo: a spirale di rame rosso
- Overall jacket: 2 * Ø 6.0 mm high grade flexible PVC
- 1st shield: Aluminium foil
- 2nd shield: dense spiral red copper wire

CODE	LENGTH
DHG505LU1 8	1,8 mt (5,91 ft)
DHG505LU3	3 mt (9,84 ft)
DHG505LU5	5 mt (16,40 ft)



DHG520

INSERT CABLE

3,5 STEREO JACK PLUG - 2 X RCA

- Guaina esterna: 2 * Ø 4.0 mm PVC ad alta flessibilità
- 1° schermo: Foglio in alluminio
- 2° schermo: a spirale di rame rosso
- Overall jacket: 2 * Ø 4.0 mm high grade flexible PVC
- 1st shield: Aluminium foil
- 2nd shield: dense spiral red copper wire

CODE	LENGTH
DHG520LU1 8	1,8 mt (5,91 ft)
DHG520LU3	3 mt (9,84 ft)
DHG520LU5	5 mt (16,40 ft)



DHG530

INSERT CABLE

6,3 STEREO JACK PLUG - 2 X RCA

- Guaina esterna: 2 * Ø 6.0 mm PVC ad alta flessibilità
- 1° schermo: Foglio in alluminio
- 2° schermo: a spirale di rame rosso
- Overall jacket: 2 * Ø 6.0 mm high grade flexible PVC
- 1st shield: Aluminium foil
- 2nd shield: dense spiral red copper wire

CODE	LENGTH
DHG530LU1 8	1,8 mt (5,91 ft)
DHG530LU3	3 mt (9,84 ft)
DHG530LU5	5 mt (16,40 ft)



DHG535

ADAPTER CABLE

2 X 6,3 MONO JACK PLUG - 2 X RCA

- Guaina esterna: 2 * Ø 6.0 mm PVC ad alta flessibilità
- 1° schermo: Foglio in alluminio
- 2° schermo: a spirale di rame rosso
- Overall jacket: 2 * Ø 6.0 mm high grade flexible PVC
- 1st shield: Aluminium foil
- 2nd shield: dense spiral red copper wire

CODE	LENGTH
DHG535LU1 8	1,8 mt (5,91 ft)
DHG535LU3	3 mt (9,84 ft)
DHG535LU5	5 mt (16,40 ft)



DHG540

INSERT CABLE

6,3 STEREO JACK PLUG - 2 X 6,3 MONO JACK PLUG

- Guaina esterna: 2 * Ø 6.0 mm PVC ad alta flessibilità
- 1° schermo: Foglio in alluminio
- 2° schermo: a spirale di rame rosso
- Overall jacket: 2 * Ø 6.0 mm high grade flexible PVC
- 1st shield: Aluminium foil
- 2nd shield: dense spiral red copper wire

CODE	LENGTH
DHG540LU1 8	1,8 mt (5,91 ft)
DHG540LU3	3 mt (9,84 ft)
DHG540LU5	5 mt (16,40 ft)



DHG545

INSERT CABLE

3,5 STEREO JACK PLUG - 2 X 6,3 MONO JACK PLUG

- Guaina esterna: 2 * Ø 4.0 mm PVC ad alta flessibilità
- 1° schermo: Foglio in alluminio
- 2° schermo: a spirale di rame rosso
- Overall jacket: 2 * Ø 4.0 mm high grade flexible PVC
- 1st shield: Aluminium foil
- 2nd shield: dense spiral red copper wire

CODE	LENGTH
DHG545LU1 8	1,8 mt (5,91 ft)
DHG545LU3	3 mt (9,84 ft)
DHG545LU5	5 mt (16,40 ft)



DHG550

BALANCED CABLE

3,5 STEREO JACK PLUG - 3,5 STEREO JACK PLUG

- Guaina esterna: Ø 6.0 mm PVC ad alta flessibilità
- 1° schermo: Foglio in alluminio
- 2° schermo: a spirale di rame rosso
- Overall jacket: Ø 6.0 mm high grade flexible PVC
- 1st shield: Aluminium foil
- 2nd shield: dense spiral red copper wire

CODE	LENGTH
DHG550LU1 8	1,8 mt (5,91 ft)
DHG550LU3	3 mt (9,84 ft)
DHG550LU5	5 mt (16,40 ft)



DHG555

EXTENSION BALANCED CABLE

3,5 STEREO JACK PLUG - 3,5 FEMALE STEREO JACK

- Guaina esterna: Ø 6.0 mm PVC ad alta flessibilità
- 1° schermo: Foglio in alluminio
- 2° schermo: a spirale di rame rosso
- Overall jacket: Ø 6.0 mm high grade flexible PVC
- 1st shield: Aluminium foil
- 2nd shield: dense spiral red copper wire

CODE	LENGTH
DHG555LU3	3 mt (9,84 ft)
DHG555LU5	5 mt (16,40 ft)



DHG560

ADAPTER BALANCED CABLE

3,5 STEREO JACK PLUG - 6,3 STEREO JACK PLUG

- Guaina esterna: Ø 6.0 mm PVC ad alta flessibilità
- 1° schermo: Foglio in alluminio
- 2° schermo: a spirale di rame rosso
- Overall jacket: Ø 6.0 mm high grade flexible PVC
- 1st shield: Aluminium foil
- 2nd shield: dense spiral red copper wire

CODE	LENGTH
DHG560LU3	3 mt (9,84 ft)
DHG560LU5	5 mt (16,40 ft)



DHG565

EXTENSION BALANCED CABLE

6,3 STEREO JACK PLUG - 6,3 FEMALE STEREO JACK

- Guaina esterna: Ø 6.5 mm PVC ad alta flessibilità
- 1° schermo: Foglio in alluminio
- 2° schermo: a spirale di rame rosso
- Overall jacket: Ø 6.5 mm high grade flexible PVC
- 1st shield: Aluminium foil
- 2nd shield: dense spiral red copper wire

CODE	LENGTH
DHG565LU3	3 mt (9,84 ft)
DHG565LU5	5 mt (16,40 ft)



DHG575

ADAPTER CABLE
6,3 MONO JACK PLUG - RCA

- Guaina esterna: Ø 6.5 mm PVC ad alta flessibilità
- 1° schermo: PVC DH
- 2° schermo: a treccia di rame rosso
- Overall jacket: Ø 6.5 mm high grade flexible PVC
- 1st shield: DH high grade PVC
- 2nd shield: dense braided red copper wire

CODE	LENGTH
DHG575LU18	1,8 mt (5,914 ft)
DHG575LU3	5 mt (9,84 ft)



DHG580

ADAPTER CABLE
3P FEMALE XLR - RCA

- Guaina esterna: Ø 6.5 mm PVC ad alta flessibilità
- 1° schermo: PVC DH
- 2° schermo: a treccia di rame rosso
- Overall jacket: Ø 6.5 mm high grade flexible PVC
- 1st shield: DH high grade PVC
- 2nd shield: dense braided red copper wire

CODE	LENGTH
DHG580LU18	1,8 mt (5,914 ft)
DHG580LU3	5 mt (9,84 ft)



DHG585

ADAPTER CABLE
3P MALE XLR - RCA

- Guaina esterna: Ø 6.5 mm PVC ad alta flessibilità
- 1° schermo: PVC DH
- 2° schermo: a treccia di rame rosso
- Overall jacket: Ø 6.5 mm high grade flexible PVC
- 1st shield: DH high grade PVC
- 2nd shield: dense braided red copper wire

CODE	LENGTH
DHG585LU18	1,8 mt (5,91 ft)
DHG585LU3	3 mt (9,84 ft)
DHG585LU5	5 mt (16,40 ft)



DHG595

STEREO CABLE
3,5 STEREO JACK PLUG - 2 X 3P MALE XLR

- Guaina esterna: 2 * Ø 4.0 mm PVC ad alta flessibilità
- 1° schermo: Foglio in alluminio
- 2° schermo: a spirale di rame stagnato
- Overall jacket: 2 * Ø 4.0 mm high grade flexible PVC
- 1st shield: Aluminium foil
- 2nd shield: dense spiral tinned copper wire

CODE	LENGTH
DHG595LU18	1,8 mt (5,91 ft)
DHG595LU3	3 mt (9,84 ft)
DHG595LU5	5 mt (16,40 ft)



CONNECTORS

ONEHERO

ONEHERO è una nuova serie di cavi assemblati e connettori dal design unico ed esclusivo, frutto della ricerca dell'R&D di PROEL che ancora una volta, ha scelto di investire risorse nella progettazione di strumenti innovativi e professionali dedicati alle crescenti richieste del mercato. Caratteristiche distintive dei connettori sono l'ergonomicità dei manicotti, realizzati in pressofusione di zinco, la punta in ottone dorato, il guscio posteriore in nylon rinforzato, il passacavo in PVC che garantisce una eccellente protezione del cavo ed una speciale pinza interna per un semplice ed ottimale serraggio. Questa gamma di prodotti, soddisfa le maggiori tipologie di connessione in ambito professionale.

ONEHERO is a new series of premade cables and connectors with a unique and exclusive design, the result of PROEL R & D that once again, chose to invest resources in the design of innovative and professional tools dedicated to the growing market demands. Distinctive characteristics of the connectors are the ergonomics of the sleeves, the zinc die-casting bodies, the gold-plated brass tips, the reinforced nylon rear shell, PVC sleeves which ensure an excellent protection of the cables and a special inner strain relief for a simple and optimum tightening. This range of products meets the major types of professional connection.



Gold plated brass tip



Zinc alloy die cast body



Identification ring



Nylon special strain relief



Nylon and PVC backshell



DHJ63MBK - DHJ63MNK

• Jack Mono Professionale ONEHERO - Ø 6.3 mm - 1/4". Robusto manicotto ergonomico realizzato in pressofusione di lega di zinco e punta in ottone dorato. Guscio posteriore in nylon rinforzato e passacavo in PVC per garantire una eccellente protezione del cavo. Speciale pinza interna per un semplice ed ottimale serraggio. Disponibile in nero opaco (DHJ63MBK) e nickel (DHJ63MNK). Fornito con anelli colorati: grigio, rosso e nero.

• ONEHERO Professional Ø 6.3 mm Mono jack plug, Featuring ergonomic and heavy duty body made by zinc alloy die-casting and golden plate brass tip. Reinforced nylon rear shell and PVC sleeve to provide excellent cable protection. Special inner strain relief for a simple and optimum tightening. Available in matt black (DHJ63MBK) and nickel (DHJ63MNK). Supplied with colored rings: grey, red and black.



DHJ63SBK - DHJ63SNK

• Jack Stereo Professionale ONEHERO - Ø 6.3 mm - 1/4", con le stesse caratteristiche del connettore Mono. Disponibile in nero opaco (DHJ63SBK) e nickel (DHJ63SNK). Fornito con anelli colorati: grigio, rosso e nero.

• ONEHERO Professional Ø 6.3 mm Stereo jack plug, featuring the same characteristics of the Mono connector. Available in matt black (DHJ63SBK) and nickel (DHJ63SNK). Supplied with colored rings: grey, red and black.



DHJ63MABK - DHJ63MANK

• Jack Mono Professionale ONEHERO - Ø 6.3 mm - 1/4" ad angolo 90° con le stesse caratteristiche del connettore dritto. Disponibile in nero opaco (DHJ63MABK) e nickel (DHJ63MANK). Fornito con anelli colorati: grigio, rosso e nero.

• ONEHERO Professional Ø 6.3 mm Mono 90° angle jack plug, featuring the same characteristics of the straight connector. Available in matt black (DHJ63MABK) and nickel (DHJ63MANK). Supplied with colored rings: grey, red and black.



DHJ35SBK - DHJ35SNK

• Jack Stereo Professionale ONEHERO - Ø 3.5 mm - 1/8". Robusto manicotto ergonomico realizzato in pressofusione di lega di zinco. La punta in ottone dorato, ha uno speciale anello distanziale che permette l'utilizzo del connettore con smartphone e tablet muniti di custodia. Passacavo posteriore in PVC per garantire una eccellente protezione del cavo. Speciale pinza interna per un semplice ed ottimale serraggio. Disponibile in nero opaco (DHJ35SBK) e nickel (DHJ35SNK).

• ONEHERO Professional Ø 3.5 mm Stereo jack plug, Featuring ergonomic and heavy duty body made by zinc alloy die-casting. The golden plate brass tip features a special spacer ring to allow the use of the connector with smartphones and tablets bearing dedicated housing. PVC back sleeve to provide excellent cable protection. Special inner strain relief for a simple and optimum tightening. Available in matt black (DHJ35SBK) and nickel (DHJ35SNK).



DHFX3PBK - DHFX3PNK

• Connettore Professionale XLR 3 poli femmina volante ONEHERO. Fornito di un innovativo pulsante di rilascio dalla connessione. Robusto manicotto ergonomico realizzato in pressofusione di lega di zinco e speciali contatti dorati per incrementare la conduttività. Guscio posteriore in nylon rinforzato e passacavo in PVC per garantire una eccellente protezione del cavo. Speciale pinza interna per un semplice ed ottimale serraggio, adatta a ricevere cavi da 3 a 7 mm di diametro. Disponibile in nero opaco (DHFX3PBK) e nickel (DHFX3PNK). Fornito con anelli colorati: grigio, rosso e nero.

• *ONEHERO 3 pole female Professional XLR cable mount connector. Supplied with an improved button for latch lock. Featuring ergonomic and heavy duty body made by zinc alloy die-casting and special gold plated contacts that increase the conductivity. Reinforced nylon rear shell and PVC sleeve to provide excellent cable protection. Special inner strain relief for a simple and optimum tightening that allows to receive cables from 3 to 7 mm diameter. Available in matt black (DHFX3PBK) and nickel (DHFX3PNK). Supplied with colored rings: grey, red and black.*



DHMX3PBK - DHMX3PNK

• Connettore Professionale XLR 3 poli maschio volante ONEHERO. Dotato di robusto manicotto ergonomico realizzato in pressofusione di lega di zinco e speciali contatti di dimensioni maggiorate per incrementare la conduttività ed evitare il movimento durante la connessione. Guscio posteriore in nylon rinforzato e passacavo in PVC per garantire una eccellente protezione del cavo. Speciale pinza interna per un semplice ed ottimale serraggio, adatta a ricevere cavi da 3 a 7 mm di diametro. Disponibile in nero opaco (DHMX3PBK) e nickel (DHMX3PNK). Fornito con anelli colorati: grigio, rosso e nero.

• *ONEHERO 3 pole Professional XLR cable mount connector. Featuring ergonomic and heavy duty body made by zinc alloy die-casting and special gold plated improved contacts that increase the conductivity and avoid moving. Reinforced nylon rear shell and PVC sleeve to provide excellent cable protection. Special inner strain relief for a simple and optimum tightening that allows to receive cables from 3 to 7 mm diameter. Available in matt black (DHMX3PBK) and nickel (DHMX3PNK). Supplied with colored rings: grey, red and black.*



DHRCAMBB – DHRCAMBR

• Connettore Professionale RCA maschio volante ONEHERO. Dotato di robusto manicotto ergonomico realizzato in pressofusione di lega di zinco e speciali contatti per incrementare la conduttività ed evitare il movimento durante la connessione. Passacavo in PVC per garantire una eccellente protezione del cavo. Disponibile in nero opaco con passacavo nero (DHRCAMBB) e passacavo rosso (DHRCAMBR).

• *ONEHERO Professional male RCA cable mount connector. Featuring ergonomic and heavy duty body made by zinc alloy die-casting and special gold plated improved contacts that increase the conductivity and avoid moving. PVC sleeve to provide excellent cable protection. Available in matt black with black sleeve (DHRCAMBB) or red sleeve (DHRCAMBR).*



DHRCAMNB – DHRCAMNR

• Connettore Professionale RCA maschio volante ONEHERO, con le stesse caratteristiche del connettore nero. Disponibile nel colore nickel con passacavo nero (DHRCAMNB) e passacavo rosso (DHRCAMNR).

• *ONEHERO Professional male RCA, featuring the same characteristics of the black connector Available in nickel plated body with black sleeve (DHRCAMNB) or red sleeve (DHRCAMNR).*



• Linea completa di adattatori professionali per tutte le diverse soluzioni di interconnessione. Realizzati con corpo interamente in metallo e ricoperti in materiale plastico ad alta resistenza, con terminazioni anticorrosione placcate in oro 24k. Colore nero. Confezione standard: 4 pezzi

• Complete line of professional adapters for different interconnecting solutions. They are constructed with solid metal body with external high grade plastic compound covering and 24k Gold plated corrosion free connections. Black color. Master pack: 4 pcs.

DHMA290

Ø 6.3 mm MONO JACK
3P FEMALE XLR



DHMA295

Ø 6.3 mm STEREO JACK
3P FEMALE XLR



DHMA300

Ø 6.3 mm MONO JACK
3P MALE XLR



DHMA305

Ø 6.3 mm STEREO JACK
3P MALE XLR



DHMA320

Ø 6.3 mm MONO JACK SOCKET
3P MALE XLR



DHMA500

RCA FEMALE
3P MALE XLR



DHMA615

3P XLR MALE
Ø 6.3 mm STEREO JACK SOCKET



DHMA625

3P FEMALE XLR
Ø 6.3 mm STEREO JACK SOCKET



DHPA108

Ø 3.5 mm STEREO JACK SOCKET
Ø 3.5 mm STEREO JACK SOCKET



DHPA122A

Ø 3.5 mm STEREO JACK
Ø 3.5 mm STEREO JACK SOCKET



DHPA120

Ø 3.5 mm STEREO JACK
Ø 6.3 mm STEREO JACK SOCKET



DHPA158

Ø 6.3 mm MONO JACK
Ø 3.5 mm STEREO JACK SOCKET



DHPA140

Ø 3.5 mm STEREO JACK
2 X Ø 3.5 mm STEREO JACK SOCKET



DHPA170

Ø 6.3 mm STEREO JACK
2 X Ø 6.3 mm STEREO JACK SOCKET



DHPA165

Ø 6.3 mm STEREO JACK
Ø 3.5 mm STEREO JACK SOCKET



DHPA190

Ø 6.3 mm MONO JACK
RCA FEMALE



DHPA180

RCA MALE
Ø 6.3 mm MONO JACK SOCKET



DHPA250

Ø 6.3 mm STEREO JACK
2 X RCA FEMALE



DHPA210

RCA SOCKET
RCA SOCKET



SOFT BAGS

ARMOR BAGS PREMIUM SERIES

Proel presenta la nuova serie di borse professionali per chitarra ARMOR, studiate per offrire la massima protezione e per soddisfare tutte le esigenze dei musicisti. Tutte le borse sono realizzate in robusto Nylon 1680D "waterproof" di alta qualità con cuciture rinforzate dal design unico. Provviste di imbottitura in DHFOAM® da 35mm complessivi e rivestimento interno in morbido velluto di colore grigio. Sono inoltre dotate di poggia manico con strap in velcro e di inserti regolabili sulla base per un ottimale posizionamento dello strumento.

Proel introduces the new ARMOR series of professional guitar bags, designed to offer maximum protection and to meet all the needs of musicians. All bags are made of durable and high quality 1680D Nylon "waterproof" with unique design reinforced seams. Provided with DHFOAM® 35mm padding and a total inner lining made of soft gray velvet. They are also equipped with Velcro fixed neck rest and adjustable padded insert on the base for an optimal positioning of the instrument.



- Morbido rivestimento interno in velluto con inserti cuciti e rinforzati per meccaniche e paletta
- Soft inner velvet lining with sewn-in additional protection for headstock and mechanics areas



- Ampie tasche frontali con numerosi scomparti per libri di musica, tablet, cavi etc.
- *Large front pockets with several compartments for music books, tablets, cables etc.*



- Maniglia dal design unico
- *Unique design handle*



- Confortevole maniglia imbottita
- *Comfortable padded handle*



- Tracolle posteriori regolabili imbottite a scomparsa, con ganci in metallo
- *Adjustable padded and retractable rear straps, with metal hooks*



- Chiusure rinforzate con Zip DH ottenute in pressofusione
- *Reinforced die cast aluminum DH zip pulls*



DHZAGB

- Borsa imbottita per chitarra Acustica. Disponibile nel colore nero.
- *Padded Acoustic guitar bag. Available in black.*



DHZCGB

- Borsa imbottita per chitarra Classica. Disponibile nel colore nero.
- *Padded Classic guitar bag. Available in black.*





DHZEBB

- Borsa imbottita per chitarra Elettrica. Disponibile nel colore nero.
- *Padded Electric guitar bag. Available in black.*



DHZEBB

- Borsa imbottita per Basso elettrico. Disponibile nel colore nero.
- *Padded electric Bass bag. Available in black.*



SOFT BAGS

ARMOR BAGS ESSENTIAL

New

Le nuova serie di borse per chitarra ARMOR ESSENTIAL è il risultato di un'attenta analisi del mercato in merito alle esigenze di studenti e musicisti sempre in movimento, che quotidianamente fanno uso di borse per il trasporto e la custodia dei propri strumenti musicali. E' nata così una linea molto funzionale e pratica, caratterizzata dall'indiscusso stile DH ARMOR. Le borse sono realizzate in Nylon 1200D "waterproof" di alta qualità, con cuciture rinforzate, imbottitura interna in DHFOAM da 25mm complessivi e rivestimento interno in morbido velluto di colore nero. Sono dotate di poggia manico regolabile e di un'ampia tasca anteriore porta spartiti con all'interno una pratica stringa in velcro fermacavo. Completano la linea ARMOR ESSENTIAL le seguenti caratteristiche:

- Tracolle posteriori imbottite e regolabili, con ganci in metallo pressofuso
- Confortevole maniglia imbottita
- Inserti in Nylon 600D cuciti e rinforzati per meccaniche e paletta
- Chiusure "reverse" da 10 con Zip DH ottenuta in pressofusione

The new ARMOR ESSENTIAL series of guitar bags is the result of a careful analysis of the market regarding the needs of students and musicians who are always on the move, who daily use bags for carrying and storing their musical instruments. Thus a very functional and practical line was born, characterized by the undisputed DH ARMOR style. The bags are made of high quality 1200D "waterproof" Nylon with reinforced stitching, 25mm DHFOAM padding and soft black velvet internal lining. They are equipped with an adjustable neck rest and a large front pocket with a practical Velcro tie to hold the cable. The following features complete the ARMOR ESSENTIAL line:

- *Padded and adjustable rucksack straps, with die-cast metal hooks*
- *Comfortable padded handle*
- *600D Nylon inserts sewn and reinforced at the mechanics and headstock areas*
- *Reversed size 10 zipper with metal moulded DH zip pulls*



- Chiusure rinforzate con Zip DH ottenute in pressofusione
- Reinforced die cast aluminum DH zip pulls



- Maniglia dal design unico
- Unique design handle



- Confortevole maniglia imbottita
- Comfortable padded handle



- Tracolle posteriori regolabili imbottite a scomparsa, con ganci in metallo
- Adjustable padded and retractable rear straps, with metal hooks



- Resistenti piedini in gomma per un appoggio sicuro
- Strong rubber feet for a secure support



DHEAGB *New*

- Borsa imbottita per chitarra Acustica. Disponibile nel colore nero.
- *Padded Acoustic guitar bag. Available in black color.*



DHECGB *New*

- Borsa imbottita per chitarra Classica. Disponibile nel colore nero.
- *Padded Classic guitar bag. Available in black color.*





DHEEGB *New*

- Borsa imbottita per chitarra Elettrica. Disponibile nel colore nero.
- Padded Electric guitar bag. Available in black color.



DHEEBB *New*

- Borsa imbottita per basso Elettrico. Disponibile nel colore nero.
- Padded Electric Bass bag. Available in black color.



SOFT BAGS

ARMOR BAGS WIND ORCHESTRA

New

Dall'esperienza dell'originale serie ARMOR, abbiamo realizzato una nuova linea di borse Professionali per strumenti a fiato, ARMOR WIND ORCHESTRA, caratterizzata dall'impiego di Nylon 1680D "waterproof" di alta qualità, rifinito con nastri in cotone di alto spessore molto resistente e cuciture rinforzate, ganci ed anelli pressofusi anticorrosione. L'imbottitura è realizzata in DHFOAM di 45 mm complessivi ed il rivestimento interno è in morbido velluto di colore nero. Le borse sono inoltre provviste di inserti rinforzati e rifiniti per la massima protezione dello strumento e di piedini in gomma resistente per un ottimale isolamento sulle superfici di contatto. Caratteristiche che ne fanno una linea di borse con i massimi standard qualitativi oggi disponibili sul mercato. Inoltre per questa serie:

- Tracolle imbottite e regolabili, con ganci in metallo pressofuso
- Tasca interna per bocchino rimovibile
- Confortevoli maniglie doppie per un agevole trasporto
- Chiusure YKK rovesciate e anticorrosione con Zip DH ottenute in pressofusione

From the experience of the original ARMOR series, we have created a new line of Professional wind instruments bags, ARMOR WIND ORCHESTRA, characterized by the use of high quality "waterproof" Nylon 1680D, finished with very strong thick cotton ribbon and reinforced seams, anti-corrosion die-cast hooks and rings. The padding is made of 45 mm DHFOAM in total and the inner lining is in soft black velvet. The bags are also equipped with reinforced and finished inserts for maximum protection of the instrument and resistant rubber feet for optimum insulation on the contact surfaces. Features that make it a line of bags with the highest quality standards available on the market today.

Also for this series:

- Padded and adjustable rucksack straps, with die-cast metal hooks
- Removable internal pocket for mouthpiece
- Comfortable double handles for easy transport
- YKK reverse anticorrosion closures with metal moulded DH zip pulls



- Chiusure rinforzate con Zip DH ottenute in pressofusione
- Reinforced die cast aluminum DH zip pulls



- Tracolle imbottite e regolabili, con ganci in metallo pressofuso
- Padded and adjustable rucksack straps, with die-cast metal hooks



- Imbottitura in DHFOAM da 45 mm con rivestimento interno in morbido velluto
- 45 mm DHFOAM padding with soft velvet lining

DHWASB New

- Borsa imbottita per sassofono contralto. Disponibile nel colore nero.
- *Padded alto saxophone bag. Available in black color.*



DHWTSB New

- Borsa imbottita per sassofono tenore. Disponibile nel colore nero.
- *Padded tenor saxophone bag. Available in black color.*



DHWTBP *New*

- Borsa imbottita per tromba. Disponibile nel colore nero.
- Padded trumpet bag. Available in black color.



DHWTBB *New*

- Borsa imbottita per trombone. Disponibile nel colore nero.
- Padded trombone bag. Available in black color.



SOFT BAGS



Borse professionali per tastiera realizzate in robusto nylon 600D "waterproof" con imbottitura in DHFOAM da 30 mm e 3 mm di imbottitura extra ricoperta in morbido tessuto. Provviste di tracolle imbottite sganciabili e regolabili con ganci in metallo, di confortevoli maniglie imbottite e di 3 ampie tasche frontali A4 per libri di musica ed accessori. All'interno hanno due morbide cinghie per fissare lo strumento ed inoltre sono dotate di due resistenti ruote per un pratico e confortevole trasporto.

Professional keyboard bags made of 600D rugged and "waterproof" nylon with 30mm DHFOAM® padding and 3mm extra inner soft lining. Featuring strong adjustable and detachable padded strap with metal hardware, comfortable foam mesh carrying handles and three A4 DIN size pockets for books and accessories. They are also equipped with inner padded straps to hold the instrument and two pairs of strong wheels for a practical and comfortable carriage.



- Ampie tasche frontali A4 per libri di musica ed accessori
- *A4 DIN size pockets for books and accessories*



- Tracolle imbottite sganciabili e regolabili con ganci in metallo
- *Adjustable and detachable padded strap with metal hardware*



- Resistenti ruote per un pratico e confortevole trasporto
- *Strong wheels for a practical and comfortable carriage*

DHMKEY76

• Borsa professionale per tastiera 76 tasti, realizzata in robusto nylon 600D "waterproof" con imbottitura in DHFOAM da 30 mm e 3 mm di imbottitura extra ricoperta in morbido tessuto. Dotata di due resistenti ruote per un pratico e confortevole trasporto. Dimensioni: 1300 (larghezza) x 450 (profondità) x 170 (altezza) mm. Imbottitura 20 mm. Colore nero.

• Professional 76 keys keyboard bag made of 600D rugged and "waterproof" nylon with 30mm DHFOAM® padding and 3mm extra inner soft lining. Featuring two pairs of strong wheels for a practical and comfortable carriage. Inner dimensions: 1300 (width) x 450 (depth) x 170 (height) mm. 20mm soft foam padding. Black colour.



DHMKEY76SL

• Borsa professionale per tastiera 76 tasti, realizzata in robusto nylon 600D "waterproof" con imbottitura in DHFOAM da 30 mm e 3 mm di imbottitura extra ricoperta in morbido tessuto. Dotata di due resistenti ruote per un pratico e confortevole trasporto. Dimensioni: 1250 (larghezza) x 370 (profondità) x 150 (altezza) mm. Imbottitura 20 mm. Colore nero.

• Professional 76 keys keyboard bag made of 600D rugged and "waterproof" nylon with 30mm DHFOAM® padding and 3mm extra inner soft lining. Featuring two pairs of strong wheels for a practical and comfortable carriage. Inner dimensions: 1250 (width) x 370 (depth) x 150 (height) mm. 20mm soft foam padding. Black colour.

DHMKEY61

• Borsa professionale per tastiera 61 tasti, realizzata in robusto nylon 600D "waterproof" con imbottitura in DHFOAM da 30 mm e 3 mm di imbottitura extra ricoperta in morbido tessuto. Dotata di due resistenti ruote per un pratico e confortevole trasporto. Dimensioni: 1090 (larghezza) x 445 (profondità) x 165 (altezza) mm. Imbottitura 20 mm. Colore nero.

• Professional 61 keys keyboard bag made of 600D rugged and "waterproof" nylon with 30mm DHFOAM® padding and 3mm extra inner soft lining. Featuring two pairs of strong wheels for a practical and comfortable carriage. Inner dimension: 1090 (width) x 445 (depth) x 165 (height) mm. 20mm soft foam padding. Black colour.





DHMKEY88SL

- Borsa professionale per tastiera 88 tasti, realizzata in robusto nylon 600D "waterproof" con imbottitura in DHFOAM da 30 mm e 3 mm di imbottitura extra ricoperta in morbido tessuto. Dotata di due resistenti ruote per un pratico e confortevole trasporto. Dimensioni: 1360 (larghezza) x 430 (profondità) x 150 (altezza) mm. Imbottitura 20 mm. Colore nero.

- Professional 88 keys keyboard bag made of 600D rugged and "waterproof" nylon with 30mm DHFOAM® padding and 3mm extra inner soft lining. Featuring two pairs of strong wheels for a practical and comfortable carriage. Inner dimensions: 1360 (width) x 430 (depth) x 150 (height) mm. 20mm soft foam padding. Black colour.

DHMKEY88

- Borsa professionale per tastiera 88 tasti, realizzata in robusto nylon 600D "waterproof" con imbottitura in DHFOAM da 30 mm e 3 mm di imbottitura extra ricoperta in morbido tessuto. Dotata di due resistenti ruote per un pratico e confortevole trasporto. Dimensioni: 1460 (larghezza) x 457 (profondità) x 160 (altezza) mm. Imbottitura 20 mm. Colore nero.

- Professional 88 keys keyboard bag made of 600D rugged and "waterproof" nylon with 30mm DHFOAM® padding and 3mm extra inner soft lining. Featuring two pairs of strong wheels for a practical and comfortable carriage. Inner dimensions: 1460 (width) x 457 (depth) x 160 (height) mm. 20mm soft foam padding. Black colour.



STRAPS

DH STRAPS

Linea completa di tracolle per Chitarra, Basso e Sassofono, ideate da musicisti per i musicisti, accessori fondamentali per qualsiasi chitarrista o bassista e suonatori di sassofoni. Realizzate a regola d'arte, con soluzioni innovative e affidabili, con l'impiego di materiali di prima scelta, come la Vera Pelle Italiana, tessuti di nylon e cotone rinforzato ed accessori in metallo, in diverse lunghezze e materiali, offrendo la massima qualità e durabilità.

Complete line of guitar, bass and saxophone straps, designed by musicians for musicians, essential accessories for any guitarist or bass player and saxophone players. Made to perfection, with innovative and reliable solutions, with the use of first-rate materials, such as the Genuine Italian Leather, reinforced nylon and cotton fabrics and metal accessories, in different lengths and materials, offering the highest quality and durability.

PERFECT SERIES

• Serie di tracolle imbottite, realizzate con Vera Pelle Italiana morbida e confortevole, rifinita a macchina e con aspetti geometrici caratterizzati dalla linearità del brand DH di cui riprende le forme, con logotipo DH in metallo pressofuso. Disponibile in tre varianti di colore.

• Series of padded guitar straps, made with genuine Italian leather, soft and comfortable, machine-finished and with geometric aspects characterized by the linearity of the DH brand of which it takes the forms, with DH die-cast metal logo. Available in three color variants.

DHSTRAP600

• Tracolla regolabile in vera pelle italiana, disponibile nei colori: marrone, grigio, rosso vinaccia.

• Adjustable shoulder strap in genuine Italian leather, available in the following colors: brown, gray, burgundy red.

DHSTRAP600BW

DHSTRAP600GR

DHSTRAP600RD



SUPERB SERIES

• Serie di tracolle regolabili imbottite, realizzate in Nylon, Poliestere e Neoprene con una forte caratterizzazione di tessuti e motivi estetici sempre con riferimento al brand DH, con terminali in Vera Pelle Italiana cuciti a macchina, con applicazione di logotipo DH in metallo pressofuso. Ganci in metallo cromato dall'aspetto robusto e gradevole, per semplici ed accurate regolazioni della lunghezza, che permettono al musicista di adattare in modo accurato lo strumento al proprio stile di suonare. Disponibili in due varianti di colore e due differenti lunghezze.

• Series of adjustable padded guitar straps, made of Nylon, Polyester and Neoprene with a strong characterization of fabrics and aesthetic motifs always with reference to the DH brand, with machine-stitched Genuine Italian leather terminals, with application of DH die-cast metal logo. Hooks in chromed metal with a robust and pleasant appearance, for simple and accurate length adjustments, which allow the musician to accurately adapt the instrument to his own style of playing. Available in two colors and two different lengths.

DHSTRAP400 S

- Tracolla regolabile in Nylon e poliestere, disponibile nei colori nero e grigio/nero. Lunghezza regolabile da 100 cm a 117 cm.
- Adjustable shoulder strap in nylon and polyester, available in total black and grey/black. Adjustable length from 100 cm to 117 cm.

DHSTRAP400BKS

DHSTRAP400GRS

DHSTRAP400 L

- Tracolla regolabile in Nylon e poliestere, disponibile nei colori nero e grigio/nero. Lunghezza regolabile da 120 cm a 150 cm.
- Adjustable shoulder strap in nylon and polyester, available in total black and grey/black. Adjustable length from 120 cm to 150 cm.

DHSTRAP400GRL

DHSTRAP400BKL

SUPREME SERIES

• Serie di tracolle comode e robuste, affidabili ed accattivanti, realizzate con due differenti tipologie di materiali, in nylon rinforzato e cotone a doppio strato, con terminali in Vera Pelle Italiana cuciti a macchina, con applicazione di logotipo DH in metallo pressofuso. Ganci in metallo cromato dall'aspetto robusto e gradevole, per semplici ed accurate regolazioni della lunghezza, che permettono al musicista di adattare in modo accurato lo strumento al proprio stile di suonare. Disponibili in diverse varianti di colore.

• Series of comfortable and sturdy, reliable and attractive guitar straps, made with two different types of materials, in reinforced nylon and double-layer cotton, with machine-stitched Genuine Italian leather terminals, with application of DH die-cast metal logo. Hooks in chromed metal with a robust and pleasant appearance, for simple and accurate length adjustments, which allow the musician to accurately adapt the instrument to his own style of playing. Available in different colors.

DHSTRAP150

• Tracolla regolabile in nylon antistrappo, disponibile nei colori: nero, rosso, grigio, blue.
 • Adjustable shoulder strap made by tear-proof nylon, available in the colors: black, red, gray, blue.



DHSTRAP250

• Tracolla regolabile in cotone rinforzato a doppio strato, disponibile nei colori: nero, grigio, beige, marrone.
 • Adjustable double layer reinforced cotton shoulder strap, available in the colors: black, gray, beige, brown.

DHSTRAP250BW

DHSTRAP250TW

DHSTRAP250GR

DHSTRAP250BK



WIND SERIES

- Serie di tracolle per sassofono, realizzate con diverse tipologie di materiali e varie forme estetiche per utilizzi professionali ed amatoriali.
- *Series of saxophone straps, made with different types of materials and various aesthetic forms for professional and amateur uses.*

DHSTRAP800

- Tracolla per sassofono in Nylon di colore nero semplice e facile da usare, dotata di robusto gancio in metallo antigraffio.
- *Simple and easy to use black Nylon saxophone neck band, equipped with a sturdy scratch-resistant metal hook.*

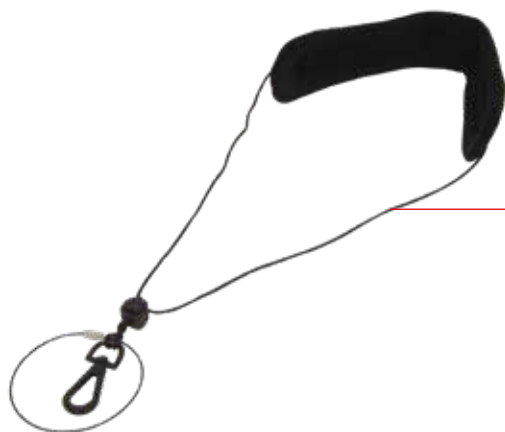

DHSTRAP810

- Tracolla per sassofono realizzata in morbido velluto imbottito di colore nero, dotata di robusto gancio in metallo antigraffio.
- *Padded soft velvet construction saxophone neck band, equipped with sturdy scratch-proof metal hook.*

DHSTRAP820

- Performante tracolla a croce per sassofono, confortevole e facile da usare, con morbida imbottitura per le spalle. Caratterizzata da molteplici regolazioni e dotata di robusto gancio metallico antigraffio. Realizzato in ultra resistente tessuto di nylon nero.
- *Performing saxophone cross strap, comfortable and easy to use, with soft shoulder padding. Characterized by multiple adjustments and equipped with a sturdy scratch-proof metal hook. Made of ultra-resistant black nylon fabric.*



ALPHABETICAL INDEX



ALPHABETICAL INDEX

CODE	PAGE	CODE	PAGE	CODE	PAGE
DHEAGB	34	DHMA305	26	DHS230	16
DHECGB	34	DHMA320	26	DHS240	16
DHEEBB	35	DHMA500	26	DHS505	16
DHEEGB	35	DHMA615	26	DHS520	16
DHFX3PBK	25	DHMA625	26	DHS530	16
DHFX3PNK	25	DHMKEY61	40	DHS535	16
DHG100	19	DHMKEY76	40	DHS540	17
DHG120	19	DHMKEY76SL	40	DHS545	17
DHG140	19	DHMKEY88	41	DHS550	17
DHG200	19	DHMKEY88SL	41	DHS560	17
DHG210	19	DHMS75	13	DHS595	17
DHG220	19	DHMSS10	12	DHS600	17
DHG230	20	DHMSS30	12	DHSS20	11
DHG240	20	DHMX3PBK	25	DHSS30	11
DHG505	20	DHMX3PNK	25	DHSS40	10
DHG520	20	DHPA108	27	DHSS50KIT	10
DHG530	20	DHPA120	27	DHSS60	10
DHG535	20	DHPA122A	27	DHSTRAP150BK	45
DHG540	21	DHPA140	27	DHSTRAP150BL	45
DHG545	21	DHPA158	27	DHSTRAP150GR	45
DHG550	21	DHPA165	27	DHSTRAP150RD	45
DHG555	21	DHPA170	27	DHSTRAP250BK	45
DHG560	21	DHPA180	27	DHSTRAP250BW	45
DHG565	21	DHPA190	27	DHSTRAP250GR	45
DHG575	22	DHPA210	27	DHSTRAP250TW	45
DHG580	22	DHPA250	27	DHSTRAP400BKL	44
DHG585	22	DHPGS10	13	DHSTRAP400BKS	44
DHG595	22	DHPMS10	7	DHSTRAP400GRL	44
DHJ35SBK	24	DHPMS30	7	DHSTRAP400GRS	44
DHJ35SNK	24	DHPMS40	5	DHSTRAP600BW	43
DHJ63MABK	24	DHPMS50	5	DHSTRAP600GR	43
DHJ63MANK	24	DHPMS55	6	DHSTRAP600RD	43
DHJ63MBK	24	DHPMS60	6	DHSTRAP800	46
DHJ63MNB	24	DHPMS70	7	DHSTRAP810	46
DHJ63SBK	24	DHRCAMBB	25	DHSTRAP820	46
DHJ63SNK	24	DHRCAMBR	25	DHWASB	37
DHKS10BK	9	DHRCAMNB	25	DHWTB	37
DHKS10SL	9	DHRCAMNR	25	DHWTPB	37
DHKS40	8	DHS100	15	DHWTSB	37
DHKS50	8	DHS120	15	DHZAGB	30
DHKS52	9	DHS140	15	DHZCGB	30
DHMA290	26	DHS200	15	DHZEBB	31
DHMA295	26	DHS210	15	DHZEGB	31
DHMA300	26	DHS220	15		

• Tutte le specifiche possono essere variate senza alcuna notifica • Design and specifications subject to change without any notice

• E' vietata la riproduzione fotostatica e fotografica del presente catalogo, o di parti di esso, in mancanza di espressa autorizzazione da parte di Proel S.p.a.
 • The photostatic and photographic reproduction of this catalogue, in whole or in part, is strictly prohibited without the prior written consent of Proel S.p.A

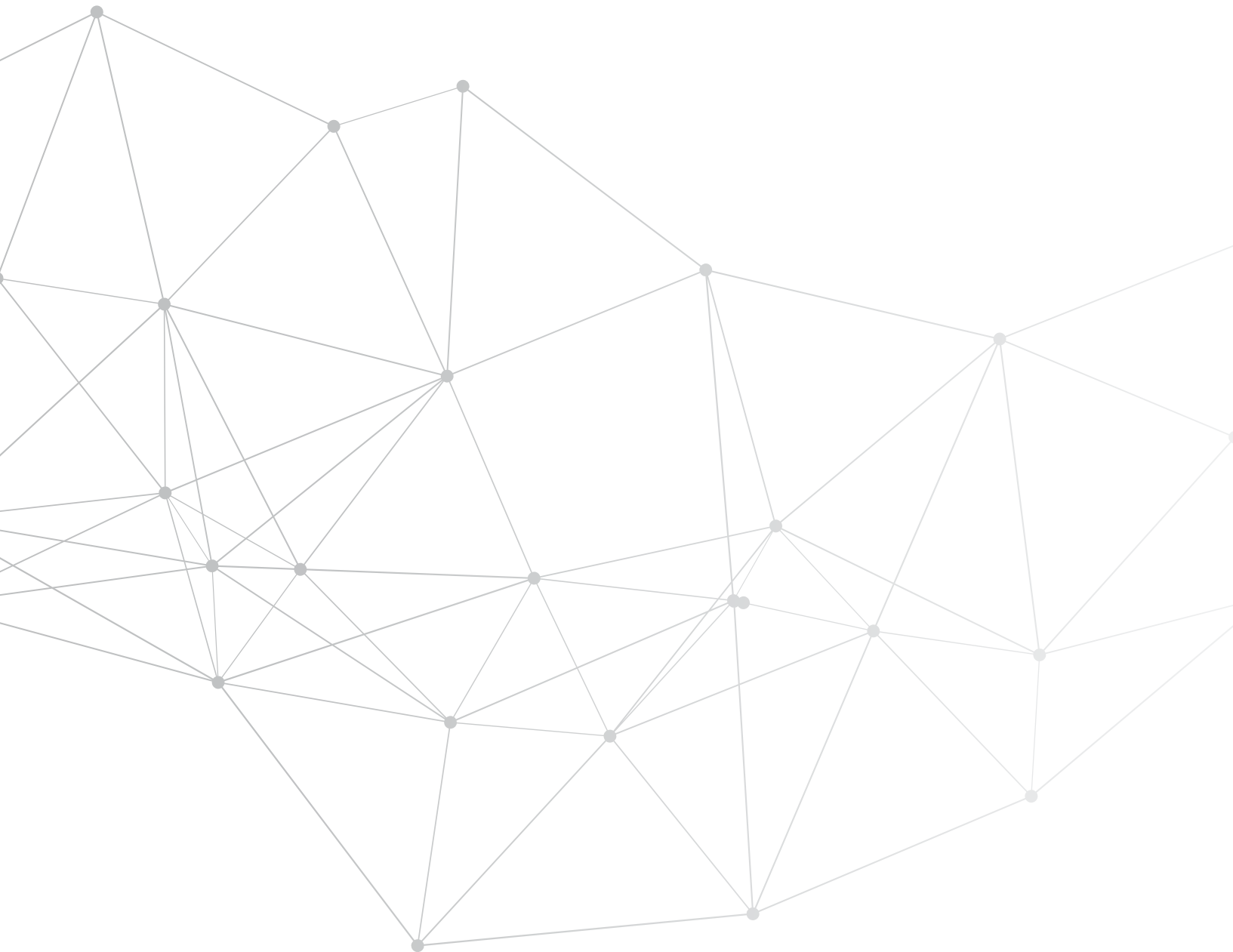

DH
is a brand of

PROEL SPA
(Worldwide Headquarters)
Via alla Ruenia, 37/43
64027 Sant'Omero (TE) - ITALY
Tel. +39 0861 81241
Fax +39 0861 887862
P.I. 00778590679
N.Reg.AEE IT 08020000002762

dhprostage.com