

PROEL 

**STAGE
EQUIPMENT**

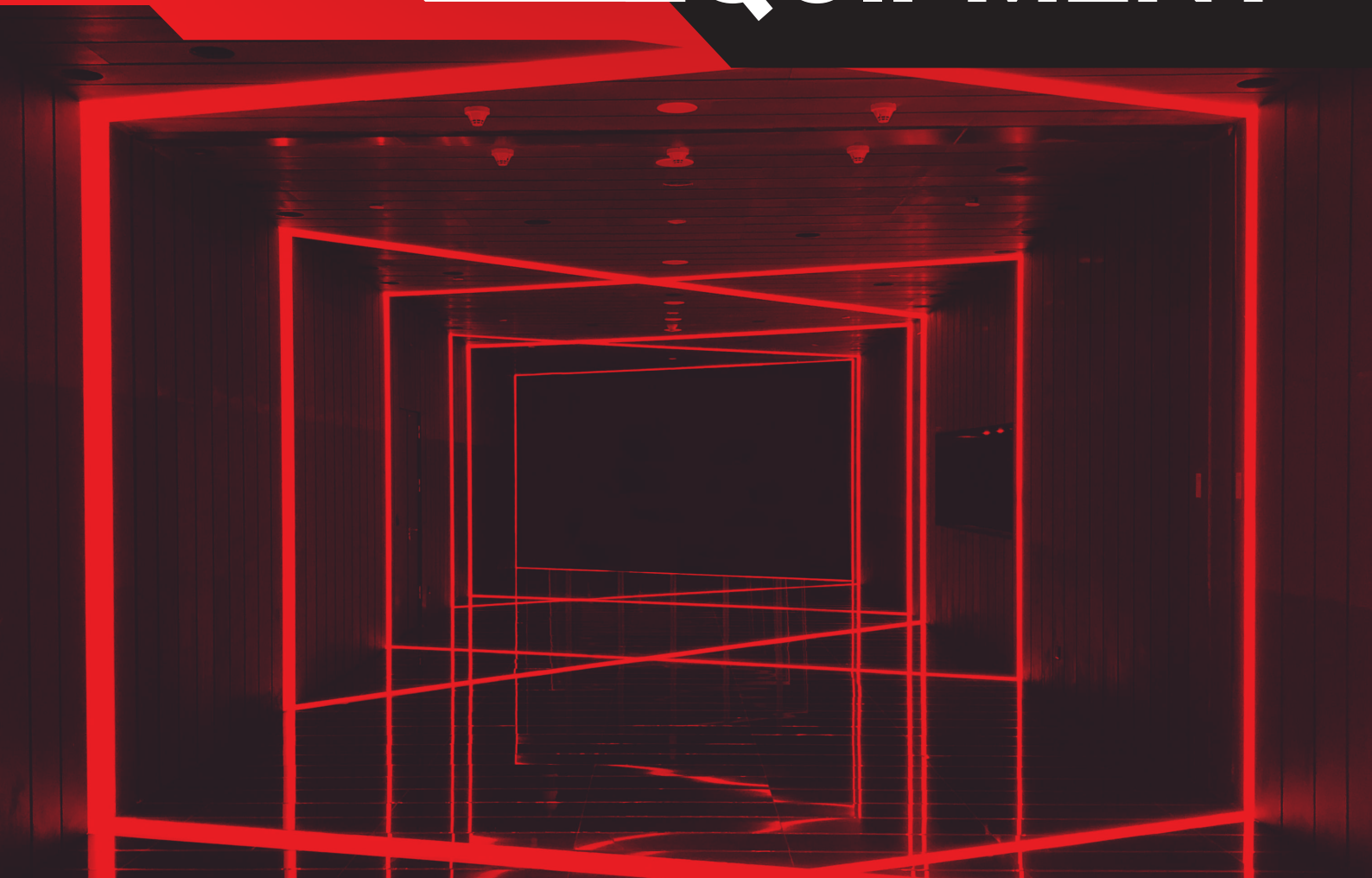

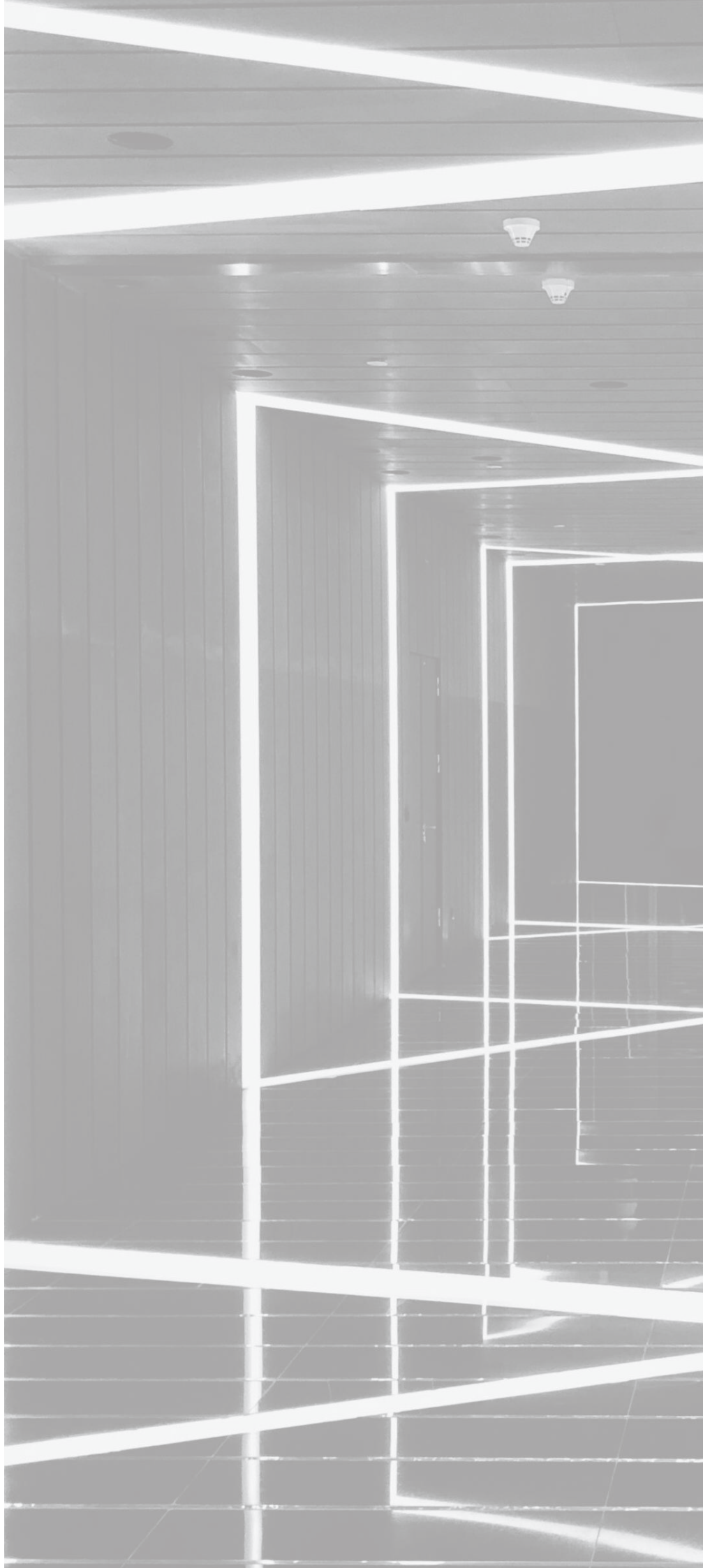



INDEX

| | |
|------------------------------------|------------|
| METAL & RACK SYSTEMS | 4 |
| PROFESSIONAL CABLES | 71 |
| CABLES IN REEL | 120 |
| CONNECTORS | 162 |
| AUDIO SYSTEMS | 186 |
| ELECTRONICS | 201 |
| ELECTRIC DISTRIBUTION | 206 |
| FLIGHT CASES | 217 |
| FLIGHT CASE ACCESSORIES | 228 |
| MOLDED UTILITY CASES - "PP" SERIES | 230 |
| FOAM CASES | 235 |
| ABS CASES - "FORCE" SERIES | 238 |
| WOODEN CASES - "CWC" SERIES | 246 |
| BAGS & STRAPS | 252 |
| WOODEN BENCHES | 267 |
| ALPHABETICAL INDEX | 272 |

METAL SYSTEM INDEX



Microphone Stands & Accessories

| | |
|---|----|
| Microphone KIT "PSE3" Series | 5 |
| Microphone Stands "ALV" Series | 6 |
| Microphone Stands "ON-STAGE" Series | 6 |
| Microphone Stands "PROSTAGE" Series | 7 |
| Microphone Stands "RSM" Series | 10 |
| Microphone Stand and accessories "RSM" Series | 14 |
| Tablet holders | 15 |
| Desktop Microphone Stands "DST" Series | 16 |
| Microphone Holder "APM" Series | 19 |
| Microphone Sponge Windscreen "WS" Series | 21 |
| Microphone Pop Filters "APOP" Series | 22 |
| Microphone Reflection Filters "PRO" Series | 22 |

Keyboard stands & Accessories

| | |
|---|----|
| Keyboard Stands "Snap Lock System" Series | 23 |
| Keyboard Stands "Easy Lock System" Series | 25 |
| Keyboard Stands "Table" Series | 27 |
| Keyboard Stands Accessories | 29 |

Guitar stands

| | |
|---------------------------|----|
| Guitar Stands "FC" series | 30 |
|---------------------------|----|

| | |
|--------------------------|----|
| Mixer Stands "KS" Series | 34 |
|--------------------------|----|

| | |
|---|----|
| Amplifier & Monitor Stands "Easy Lock" Series | 35 |
|---|----|

| | |
|--|----|
| Monitor & Laptop Stands "KP800" Series | 36 |
|--|----|

| | |
|--------------------------------|----|
| Projector mounts "PRPH" Series | 38 |
|--------------------------------|----|

| | |
|--------------------------|----|
| Keyboard benches & Stool | 39 |
|--------------------------|----|

| | |
|--------------------------------|----|
| Drummer's stool & throne "SGB" | 40 |
|--------------------------------|----|

| | |
|----------------------------|----|
| Laptop Stands "LTS" Series | 41 |
|----------------------------|----|

Music Stands

| | |
|---------------------------------------|----|
| Music Stands "RSM" Series | 42 |
| LED Lamps "MSLL" Series & Lamp Holder | 45 |
| Gooseneck Led Lights "SDC" Series | 46 |

Speaker Stands & Accessories

| | |
|--|----|
| Speaker Stands "SPSK" Series | 47 |
| Speaker Stands "FRE" Series | 49 |
| Speaker Stands & Accessories "KP" Series | 50 |
| Wall Mount "KP500" Series | 52 |

Lighting Stands

| | |
|--|----|
| Professional Lighting Stands "P LWIN" Series | 53 |
|--|----|

| | |
|-------------------------------|----|
| Lighting Stands & Accessories | 57 |
|-------------------------------|----|

| | |
|----------------------|----|
| Lighting Stand & Set | 58 |
|----------------------|----|

| | |
|-----------------------------|----|
| Lighting stands accessories | 59 |
|-----------------------------|----|

| | |
|------------------------------------|----|
| Professional trolley "KART" Series | 60 |
|------------------------------------|----|

19" Rack stands, Cabinets & Accessories

| | |
|-----------------------------|----|
| 19" Rack Stands "KR" Series | 61 |
|-----------------------------|----|

| | |
|-----------------------------------|----|
| 19" Rack Stands "STUDIORK" Series | 62 |
|-----------------------------------|----|

| | |
|-------------------------|----|
| 19" Rack Cabinets "FSR" | 64 |
|-------------------------|----|

| | |
|--|----|
| 19" Wall Mount rack cabinets "WMRC" Series | 65 |
|--|----|

| | |
|-----------------------------|----|
| 19" Rack Panels "RK" Series | 66 |
|-----------------------------|----|

| | |
|--------------------------------|----|
| 19" Rack Shelves "ADRK" Series | 68 |
|--------------------------------|----|

| | |
|--|----|
| 19" Rack Drawers & Shelf "ADRK" Series | 69 |
|--|----|

| | |
|----------------------|----|
| 19" Rack Accessories | 70 |
|----------------------|----|

MICROPHONE KIT "PSE" SERIES

METAL SYSTEM

• Il PSE3 è la versione ideale del kit microfonico, studiato per i giovani che muovono i primi passi nel mondo della musica. Il kit include i seguenti articoli: RMS180V2 (asta microfonica nera), DM800 (microfono dinamico), BULK250LU6 (cavo microfonico da 6 mt con connettori xlr Proel in alluminio pressofuso) e APM20 (supporto microfonico in gomma). Il kit è fornito in una pratica borsa di trasporto in nylon.

• The PS3 is the perfect version of the microphone set, studied for young people who are moving the initial steps in the world of music. The set includes the items RSM180V2 (Black microphone stand), DM800 (Dynamic microphone), BULK250LU6 (6 mt microphone cable with metal housing and backshell Proel connectors) and APM20 (rubber microphone holder). All of them in a practical nylon carrying bag.



DM800



APM20



BULK250LU6



PSE3

Componenti

- RSM180V2 - Asta microfonica nera professionale con base tripode in nylon. Pratico manicotto per la regolazione dell'altezza. Giraffa regolabile. Piedini anti scivolo.
- DM800 - Capsula dinamica. Schema polare iper-cardioide. Impedenza di uscita 600 ohm. Interruzione on-off.
- BULK250LU6 - Cavo microfonico professionale OFC - 6 mt. Connettori professionali XLR Proel in alluminio pressofuso e contatti argentati.
- APM20 - Supporto in gomma speciale per microfono, dotato di adattatore 3/8" - 5/8".
- PSE2BAG - Pratica borsa in nylon per il trasporto del set (Prodotto non vendibile separatamente).

Components

- RSM180V2 - Microphone stand with boom, tripod nylon base. Available in matt black (RSM180).
- DM800 - Vocal microphone with exceptional transparency at mid-bass frequencies, cardioid polar pattern, incorporated on/off switch.
- BULK250LU6 - Professional assembled balanced cable with PROEL XLR 3P male - PROEL XLR 3P female cable mount metal housing and backshell connections. 6 mt length.
- APM20 - Special rubber microphone holder (Ø Min - Max: 22 - 26 mm) with 3/8" - 5/8" thread adapter.
- PSE2BAG - Practical black Nylon carrying bag with inner padded pockets for microphone and microphone cable. Not available separately.

MICROPHONES STANDS "ALV" - "ON-STAGE SERIES"

METAL SYSTEM



- La linea di supporti per microfono ALV è caratterizzata da una struttura tubolare in acciaio verniciato, con base circolare in ghisa che aderisce saldamente al terreno riducendo la trasmissione delle vibrazioni. È possibile impilare fino a 6 aste sulla medesima base agevolandone il trasporto. Tutte le parti sono sostituibili. Disponibile con finiture antigraffio in nero opaco.

- The ALIVE line microphone stands feature an enamelled steel tube structure with round cast iron base firmly stands on the floor reducing noise transmission. It is possible to easily stack and carry up to 6 microphone stands on the base. All parts are replaceable. Available with matt black scratch-proof finish.



- La linea di supporti professionali per microfono ON STAGE è caratterizzata da una base circolare in ghisa con anello circolare in gomma per evitare qualunque vibrazione/feedback. Tutte le parti sono sostituibili. Disponibile con finiture antigraffio in nero opaco.

- The ON STAGE line microphone stands feature a heavy round cast iron base with rubber ring to avoid any vibration/feedback. All parts are replaceable. Available with matt black scratch-proof finish.

ALV130BK



Weight: 3,95 kg
Cast iron

OST110BK



Weight: 5,10 kg
Cast iron

OST200BK



Weight: 6,10 kg
Cast iron

ALV130BK

- Asta salvaspazio professionale dritta per microfono, con base in ghisa pesata impilabile e manico di regolazione in nylon. Disponibile in nero opaco (ALV130BK).
- Professional space-saving straight microphone stand with heavy stackable cast iron base and nylon clutch-style height-adjustment. Available in matt black (ALV130BK).

OST110BK

- Asta professionale per microfono dritta, con base in ghisa con anello circolare in gomma antivibrazione e manico di regolazione in nylon. Disponibile in nero opaco (OST110BK).
- Professional straight microphone stand with anti-vibration rubber ring cast iron base and nylon clutch-style height-adjustment. Available in matt black (OST110BK) finish.

OST200BK

- Asta professionale con giraffa telescopica per microfono, dotata di base in ghisa con anello circolare in gomma anti-vibrazione e manico in nylon per la regolazione dell'altezza. Disponibile in nero opaco (OST200BK).
- Professional microphone stand with telescopic boom; featuring anti-vibration rubber ring, cast iron base and nylon clutch-style height-adjustment. Available in matt black finish (OST200BK).

TECH INFO

| Model: | ALV130BK | OST110BK | OST200BK |
|--------------------|--------------------|---------------------|-------------------------------|
| Base dimension: | Ø 250 mm (9,84") | Ø 300 mm (11.8") | Ø 300 mm (11.8") |
| Minimum height: | 950 mm (37.40") | 950 mm (37.40") | 950 mm (37.40") |
| Maximum height: | 1650 mm (64.96") | 1650 mm (64.96") | 1650 mm (64.96") |
| Weight: | 3.95 kg (8.71 lbs) | 5.10 kg (11.24 lbs) | 6.10 kg (13.44 lbs) |
| Available colors:w | Black | Black | Black |
| Boom length: | -- | -- | 540 mm/840 mm (21.26"/33.07") |
| Master Carton: | 6 pcs. | 6 pcs. | 6 pcs. |

MICROPHONE STANDS "PROSTAGE" SERIES

METAL SYSTEM

• Il segreto di questa serie di supporti professionali per microfono risiede nell'uso di componenti ad alta tecnologia. Il design altamente funzionale si unisce all'asta ultrasensibile, e consente la massima affidabilità nell'utilizzo. Queste aste microfoniche sono dotate di snodo in alluminio pressofuso, di un nuovo sistema in nylon per la regolazione dell'altezza, di sistemi di scorrimento protetti e precisi e di piedini in gomma naturale antiscivolo. Tutte le chiusure sono protette da finiture antigraffio. La struttura ha, inoltre, alta resistenza agli impatti. Tutte le parti sono sostituibili. Disponibile con finiture antigraffio in nero opaco o cromate.

• The secret of this professional microphone stand series is to be found in the use of high tech components. The highly functional design combined with the sturdy stand, allows maximum reliability of usage. It features a die-cast aluminum boom swivel joint, new nylon system height adjustment, protected and precise clutch-style adjustment system; anti-skid natural rubber footcaps. All locks are protected by scratchproof finish. Highly impact-resistant. All parts are replaceable. Available with matt black scratch-proof or chrome plated finish.

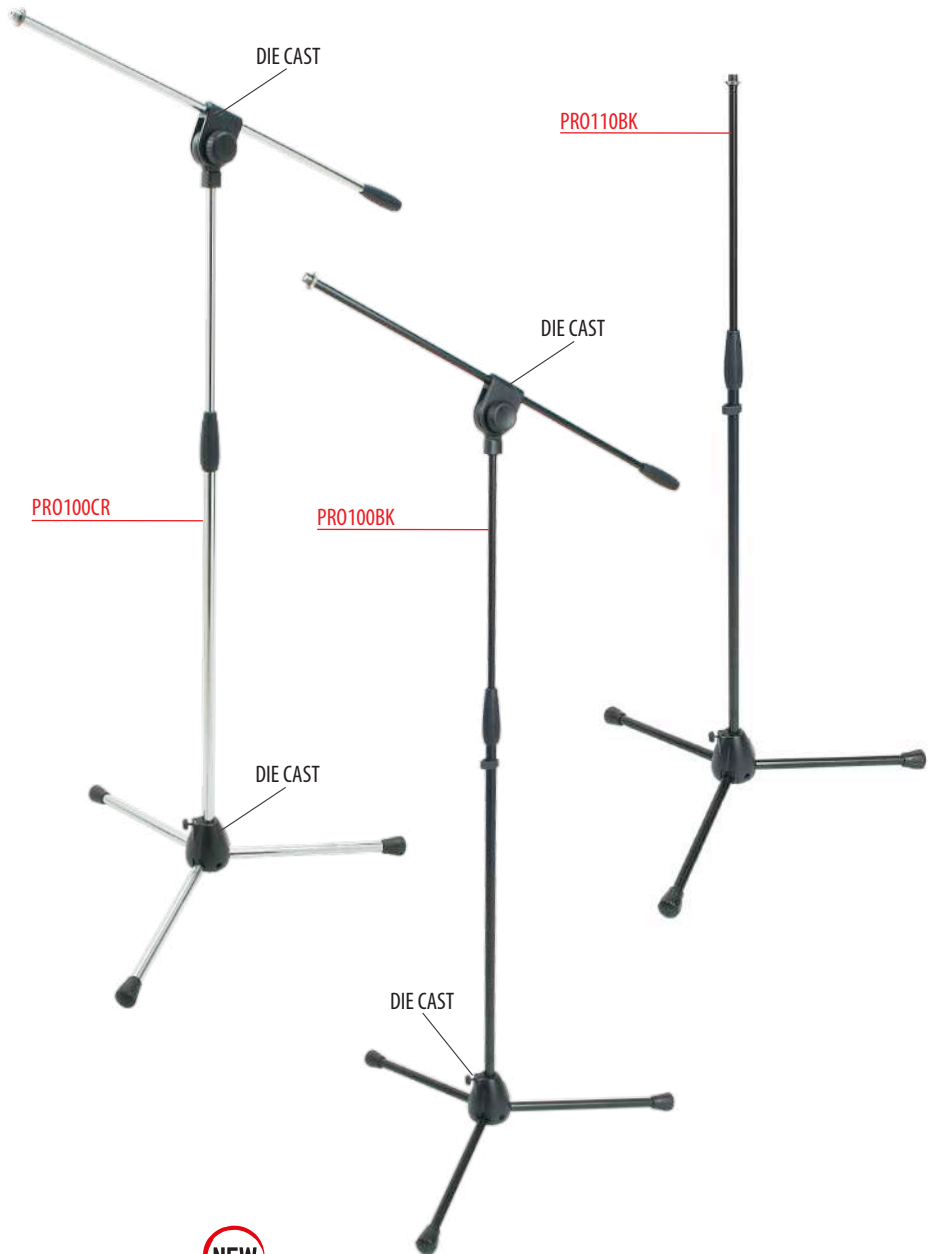

PRO110BK NEW

- Asta professionale dritta per microfono, con base tripode in alluminio pressofuso e manico di regolazione in nylon. Disponibile in nero opaco (PRO110BK).
- Professional straight microphone stand with tripod die-cast aluminum base and nylon clutch-style height adjustment. Available in matt black finish.

PRO100CR - PRO100BK

- Asta professionale a giraffa per microfono, con base tripode in alluminio e manico di regolazione in nylon. Disponibile in nero opaco (PRO100BK) e cromata (PRO100CR).
- Professional microphone stand with boom, tripod die-cast aluminum base and nylon clutch-style height adjustment. Available in matt black (PRO100BK) and chrome plated (PRO100CR) finish.

TECH INFO

| Model | PRO100BK - PRO100CR | PRO110BK |
|-------------------|---------------------------------------|---------------------|
| Base Dimension | Ø 700 mm - (27.56") | Ø 700 mm - (27.56") |
| Minimum height | 950 mm (37.40") | 860 mm (33.86") |
| Maximum height: | 1600 mm (63.00") | 1500 mm (59.06") |
| Weight | 3.3 kg (7.28 lbs) | 2.60 kg (5.73 lbs) |
| Available colors: | Black (PRO100BK) Chrome (PRO100CR) | Black (PRO110BK) |
| Boom length | 750 mm (29.53") | - |
| Master Carton: | 6 pcs. | 6 pcs. |



MICROPHONE STANDS "PROSTAGE" SERIES

METAL SYSTEM



PRMSBAG

- Borsa in nylon rinforzato per aste microfoniche. Disponibile nel colore nero. Dimensioni: 1150 x 160 x 160 mm
- Heavy duty reinforced nylon bag for microphone stands. Available in black. Dimensions: 1150 x 160 x 160 mm



PRO281BK

- Asta professionale "nana" a giraffa telescopica per microfono, con base tripoide in alluminio e manico di regolazione in nylon. Disponibile in nero opaco (PRO281BK).
- Professional low-level microphone stand with telescopic boom, tripod aluminium base and nylon clutch-style height adjustment. Available in matt black (PRO281BK) finish.

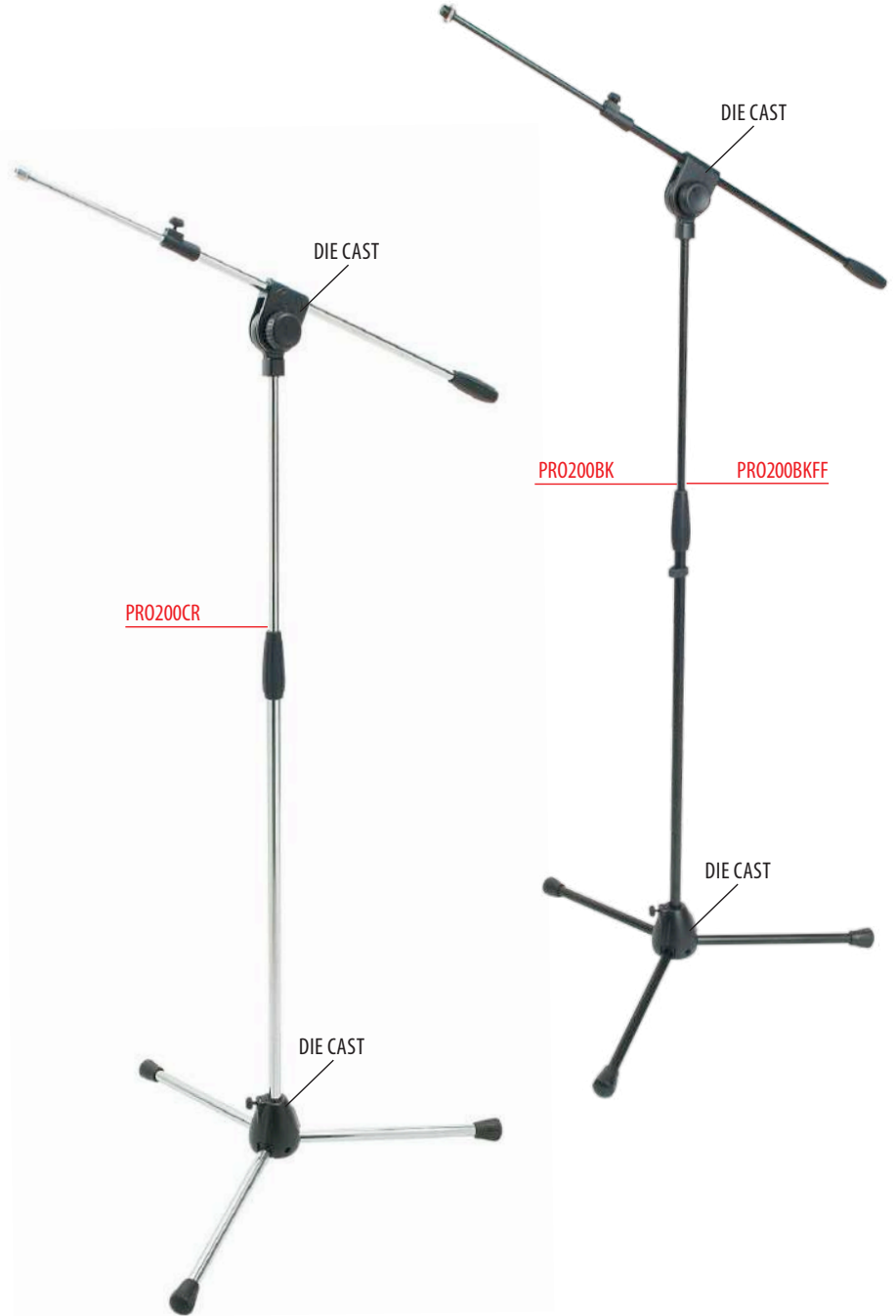

DIE CAST BASE DETAIL

PRO200BK - PRO200CR - PRO200BKFF

- Asta professionale a giraffa telescopica per microfono, con base tripoide in alluminio e manico di regolazione in nylon. Disponibile in nero opaco (PRO200BK), nero opaco con tubolari della base pieni (PRO200BKFF) e cromata (PRO200CR).
- Professional microphone stand with telescopic boom, tripod aluminium base and nylon clutch-style height adjustment. Available in matt black (PRO200BK), chrome plated (PRO200CR) and matt black finish with heavy solid base tubes (PRO200BKFF).

TECH INFO

| Model | PRO200BK - PRO200CR | PRO200BKFF | PRO281BK |
|-------------------|---------------------------------------|-------------------------------|-------------------------------|
| Base Dimension | Ø 700 mm - (27.56") | Ø 700 mm - (27.56") | Ø 700 mm - (27.56") |
| Minimum height | 950 mm (37.40") | 860 mm (33.86") | 570 mm (22.44") |
| Maximum height: | 1600 mm (62.99") | 1500 mm (59.06") | 1000 mm (39.37") |
| Weight | 3.3 kg (7.28 lbs) | 5.70 kg (12.57 lbs) | 2.60 kg (5.73 lbs) |
| Available colors: | Black (PRO200BK) Chrome (PRO200CR) | Black (PRO200BKFF) | Black (PRO281BK) |
| Boom length | 540 mm/840 mm (21.26"/33.07") | 540 mm/840 mm (21.26"/33.07") | 540 mm/840 mm (21.26"/33.07") |
| Master Carton: | 6 pcs. | 6 pcs. | 6 pcs. |

MICROPHONE STANDS "PROSTAGE" SERIES

METAL SYSTEM



PRO300BK



PRO300BK



PRO400BK

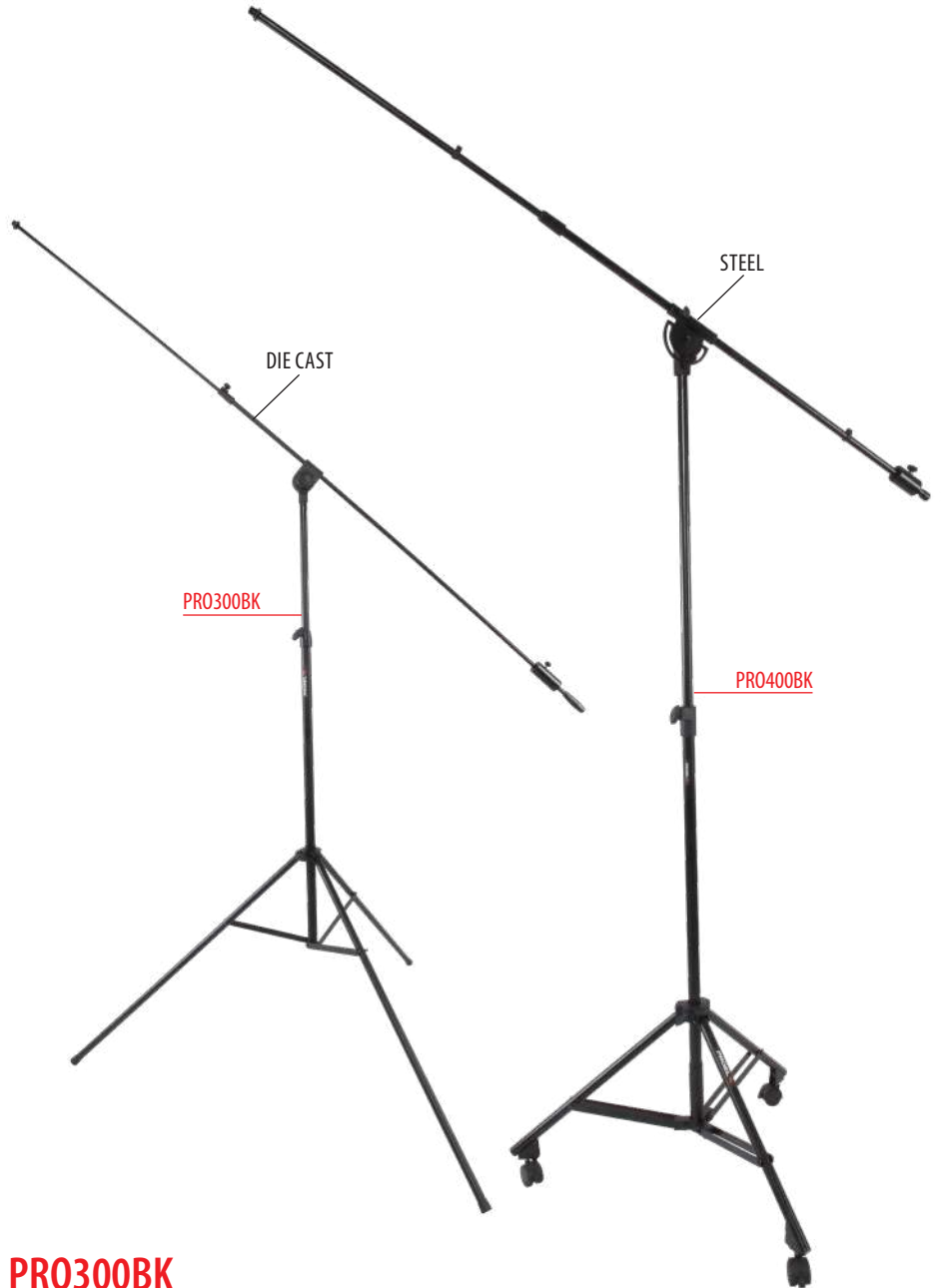

PRO300BK

- Asta microfonica professionale di grandi dimensioni a giraffa telescopica con contrappeso in acciaio per il bilanciamento. Adatta per studi di registrazione ed eventi "live". Snodo superiore in alluminio pressofuso, base tripode e manico di regolazione per l'altezza in nylon. Disponibile in nero opaco (PRO300BK).
- Professional large dimension microphone stand with telescopic boom and steel counterweight for balancing. Suitable for recording studios and "live" events. Featuring upper joint in die-cast aluminum, nylon made tripod legs joint and height adjusting sleeve. Available in matte black (PRO300BK).

PRO400BK

- Asta microfonica professionale di grandi dimensioni con giraffa telescopica con ruote frenanti e pivotanti Ø 50 mm. Adatta per studi di registrazione ed eventi "live". Dotata di snodo superiore e contrappeso regolabili in acciaio, per un'ottimale regolazione e bilanciamento. Base tripode e manico di regolazione dell'altezza in nylon. Gambi in acciaio pieno con doppia barra di collegamento per assicurare una maggiore stabilità. Disponibile in nero opaco (PRO400BK).
- Professional large dimension microphone stand with telescopic boom large and Ø 50 mm swivel castors with brake. Suitable for recording studios and "live" events. Equipped with adjustable stainless steel upper joint and counterweight for an optimal setting and balancing. Nylon made tripod legs joint and height adjustment sleeve. Solid steel legs with double connecting bar to ensure greater stability. Available in matt black (PRO400BK).

TECH INFO

| Model: | PRO300BK | PRO400BK |
|-------------------|-----------------------------------|-----------------------------------|
| Base Dimension: | Ø 1500 mm - (59.05") | Ø 1060 mm - (53.54") |
| Minimum height: | 1600 mm (63.00") | 1360 mm (59.45") |
| Maximum height: | 2350 mm (92.50") | 2300 mm (90.55") |
| Weight: | 5.20 kg (11.46 lbs) | 12.25 kg (27.00 lbs) |
| Available colors: | Black | Black |
| Boom length: | 1350 mm (53.15")/2050 mm (80.71") | 1180 mm (46.46")/2210 mm (87.00") |
| Master Carton: | 1 pc. | 1 pc. |

MICROPHONE STANDS "RSM" SERIES

METAL SYSTEM

• Sin dalla sua introduzione, questa collaudata linea di aste per microfono ha rappresentato un prodotto estremamente competitivo, ora ridisegnato e perfezionato: la struttura in acciaio tubolare garantisce massima affidabilità e durata ed è composta dal nuovo snodo in metallo stampato che permette regolazioni precise. Le gambe si ripiegano per un'agevole trasporto. Tutte le parti di bloccaggio e di frizionamento sono realizzate in gomma naturale, mentre quelle di scorrimento sono in nylon. Disponibile con finiture in nero opaco.

• This established line of microphone stands has offered a highly competitive product since its introduction and now it has been redesigned and enhanced: heavy duty tube structure grants maximum reliability and durability. It features a new molded metal swivel joint for a perfect adjustment. Legs fold down for an easy storage and transport. All locking and friction joints are made with natural rubber whereas sliding joints are made with nylon. Available with matt black finish.



RSM100BK

- Asta a giraffa per microfono, con base tripode in alluminio pressofuso. Disponibile in nero opaco (RSM100BK).
- Microphone stand with boom with tripod die-cast aluminium base. Available in matt black (RSM100BK) finish.

RSM200BK

- Asta a giraffa telescopica per microfono, con base tripode in alluminio pressofuso. Disponibile in nero opaco (RSM200BK).
- Microphone stand with boom with tripod die-cast aluminium base. Available in matt black (RSM200BK) finish.

TECH INFO

| Model: | RSM100BK | RSM200BK |
|-------------------|-------------------|---------------------------------|
| Base Dimension: | Ø 700 mm (27.56") | Ø 700 mm (27.56") |
| Minimum height: | 950 mm (37.40") | 950 mm (37.40") |
| Maximum height: | 1600 mm (62.99") | 1600 mm (62.99") |
| Weight: | 3.3 kg (7.28 lbs) | 2.60 kg (5.73 lbs) |
| Available colors: | Black | Black |
| Boom length: | 750 mm (29.53") | 565 mm (22.24")/860 mm (33.86") |
| Master Carton: | 6 pcs. | 6 pcs. |



MICROPHONE STANDS "RSM" SERIES

METAL SYSTEM



RSM192BK



RSM195BK

DIE CAST

RSM192BK

• Asta professionale "nana", con giraffa telescopica per microfono. Dotata di base tripoide realizzata in alluminio pressofuso ad elevata stabilità, corredata di snodi in nylon per il movimento dei gambi. Snodo superiore di regolazione completamente in acciaio con raccordo in alluminio pressofuso. Manicotto per la regolazione dell'altezza e contrappeso realizzati in gomma "soft grip". Disponibile nella finitura nero opaco antigraffio.

• Professional low-level microphone stand with telescopic boom. Equipped with high stability die cast aluminium tripod base, bearing nylon joints to ensure a fluid legs movement. Fully adjustable steel upper joint with die cast junction. Provided with clutch for height adjusting and counterweight made of "soft grip" rubber. Available in scratch-resistant matte black finish.

RSM195BK

• Asta professionale con giraffa per microfono. Dotata di base tripoide realizzata in alluminio pressofuso ad elevata stabilità, corredata di snodi in nylon per il movimento dei gambi. Snodo superiore di regolazione completamente in acciaio con raccordo in alluminio pressofuso. Manicotto per la regolazione dell'altezza e contrappeso realizzati in gomma "soft grip". Disponibile nella finitura nero opaco antigraffio.

• Professional microphone stand with boom. Equipped with high stability die cast aluminium tripod base, bearing nylon joints to ensure a fluid legs movement. Fully adjustable steel upper joint with die cast junction. Provided with clutch for height adjusting and counterweight made of "soft grip" rubber. Available in scratch-resistant matte black finish.



DIE CAST base with nylon insert

TECH INFO

| | RSM192BK | RSM195BK |
|--------------------------|--------------------------------|-------------------|
| Model: | RSM192BK | RSM195BK |
| Base Dimension: | Ø 720 mm (28.34") | Ø 720 mm (28.34") |
| Minimum height: | 570 mm (22.44") | 975 mm (38.38") |
| Maximum height: | 930 mm (36.61") | 1580 mm (62.20") |
| Weight: | 1.7 kg (3.75 lbs) | 2.2 kg (4.85 lbs) |
| Available colors: | Black (RSM192BK) | Black (RSM195BK) |
| Boom length: | 560 mm/810 mm (22.04"/ 31.89") | 820 mm (32.28") |
| Master Carton: | 6 pcs. | 6 pcs. |

MICROPHONE STANDS "RSM" SERIES

METAL SYSTEM



RSM197BK



RSM198BK

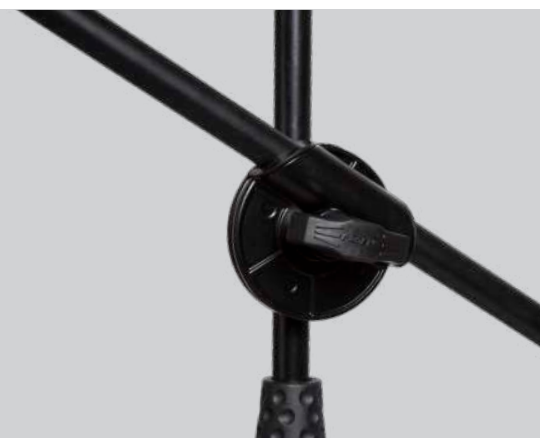

DIE CAST base with nylon insert

RSM197BK NEW

- Asta professionale doppia per microfono, con giraffa regolabile lungo il tubo verticale e terminazioni con filettatura 3/8 (adattatori 5/8 inclusi). Dotata di base tripode realizzata in alluminio pressofuso ad elevata stabilità, corredata di snodi in nylon per il movimento dei gambi. Snodo di regolazione completamente in alluminio pressofuso. Manicotto per la regolazione dell'altezza e contrappeso realizzati in nylon "soft grip". Disponibile nella finitura nero opaco antigraffio.
- Professional double microphone stand, with adjustable boom along the vertical tube and 3/8 threaded terminations (5/8 adapters included).
- Equipped with high stability die cast aluminium tripod base, bearing nylon joints to ensure a fluid legs movement. Fully adjustable die-cast aluminium joint. Provided with clutch for height adjusting and counterweight made of "soft grip" nylon. Available in scratch-resistant matte black finish.

RSM198BK

- Asta professionale con le stesse caratteristiche della RSM195BK, ma con giraffa telescopica. Disponibile nella finitura nero opaco antigraffio.
- Professional microphone stand with same features as per RSM195BK but with telescopic boom. Available in scratch-resistant matte black finish.

TECH INFO

| Model: | RSM197BK | RSM198BK |
|--------------------------|--------------------------------|--------------------------------|
| Base Dimension: | Ø 720 mm (28.34") | Ø 720 mm (28.34") |
| Minimum height: | 975 mm (38.38") | 975 mm (38.38") |
| Maximum height: | 1580 mm (62.20") | 1580 mm (62.20") |
| Weight: | 2.1 kg (4.63 lbs) | 2.1 kg (4.63 lbs) |
| Available colors: | Black (RSM197BK) | Black (RSM198BK) |
| Boom length: | 560 mm/810 mm (22.04"/ 31.89") | 560 mm/810 mm (22.04"/ 31.89") |
| Master Carton: | 6 pcs. | 6 pcs. |

MICROPHONE STANDS "RSM" SERIES

METAL SYSTEM



HIGH GRADE NYLON JOINT

• Sin dall' inizio della sua introduzione, questa linea di supporti per microfoni si è rivelata estremamente competitiva. Il suo successo risiede nell'uso di componenti tecnologicamente avanzati a prezzi competitivi, design creativo e stabilità. Tali supporti sono fabbricati con materiali attentamente scelti, come tutti i particolari scorrevoli in nylon e gli inserti in ottone: ciò assicura un'alta qualità di funzionamento nel tempo. Disponibili con finiture in nero opaco o cromate.

• This line of microphone stands has turned out to be highly competitive since its introduction. Its success is to be found in the use of high-tech components at competitive prices, creative design and stability. The stands are made with accurately chosen materials, such as all nylon sliding joints and brass inserts granting long lasting high quality. Available with matt black or chrome plated finish.



RSM180

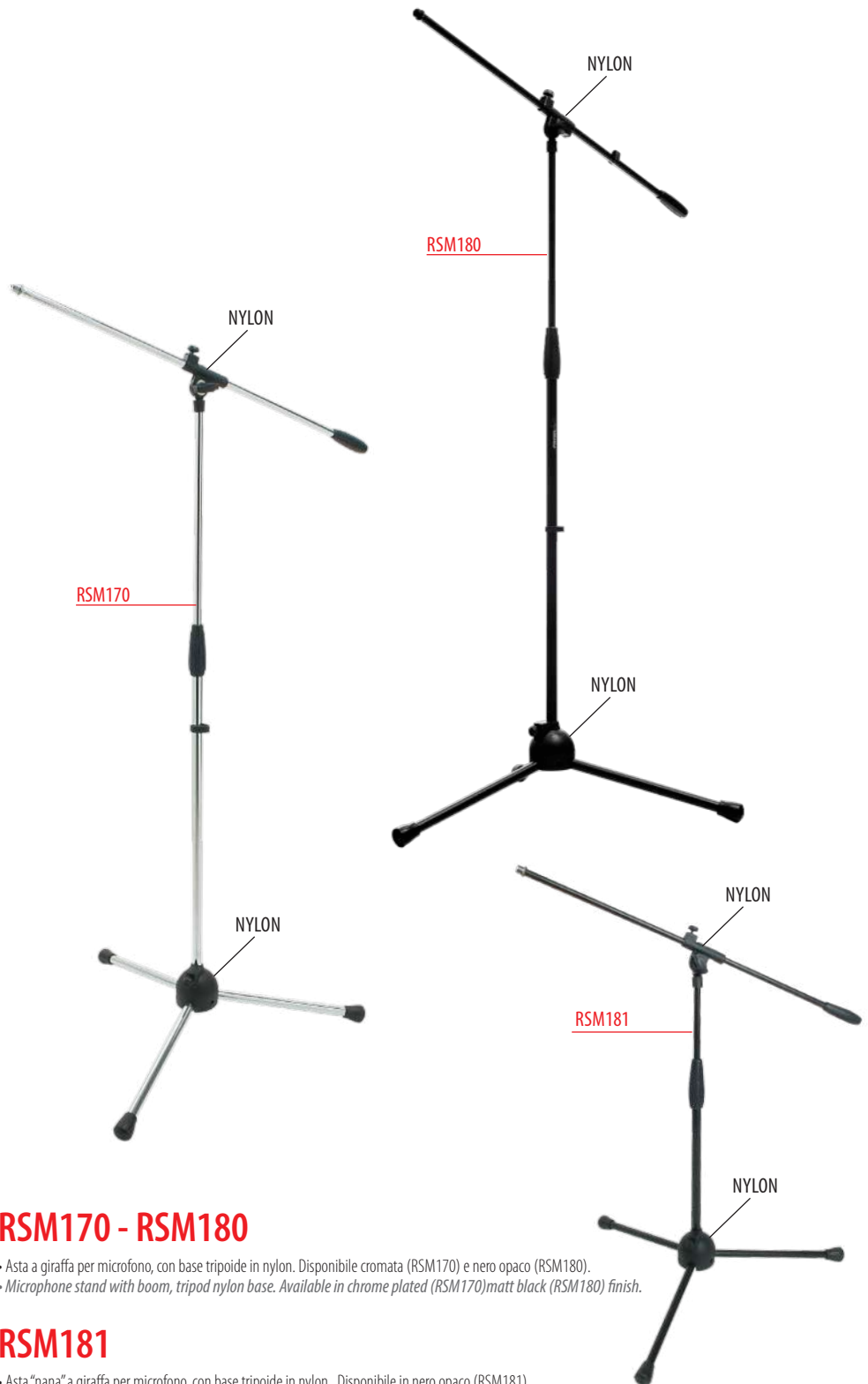

RSM170 - RSM180

- Asta a giraffa per microfono, con base tripode in nylon. Disponibile cromata (RSM170) e nero opaco (RSM180).
- Microphone stand with boom, tripod nylon base. Available in chrome plated (RSM170) matt black (RSM180) finish.

RSM181

- Asta "nana" a giraffa per microfono, con base tripode in nylon. Disponibile in nero opaco (RSM181).
- Low-level microphone stand with boom, tripod nylon base. Available in matt black finish (RSM181).

| TECH INFO | | |
|-------------------|-----------------------------------|--------------------|
| Model: | RSM170 - RSM180 | RSM181 |
| Base Dimension: | Ø 680 mm (26.77") | Ø 680 mm (26.77") |
| Minimum height: | 900 mm (00.00") | 500 mm (19.69") |
| Maximum height: | 1500 mm (59.05") | 850 mm (33.46") |
| Weight: | 2.20 kg (4.85 lbs) | 2.30 kg (5.07 lbs) |
| Available colors: | Chrome (RSM170) Black (RSM180) | Black |
| Master Carton: | 6 pcs. | 6 pcs. |
| Boom length: | 750 mm (29.53") | 750 mm (29.53") |

MICROPHONE STAND AND ACCESSORIES

METAL SYSTEM

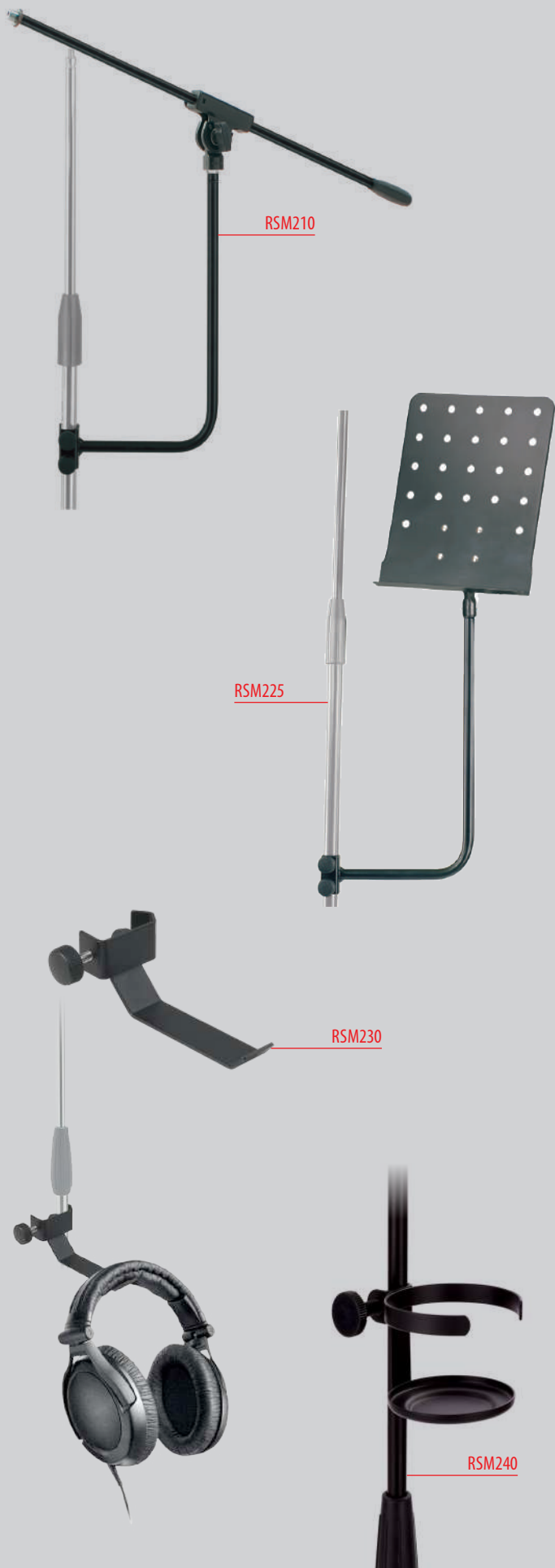

PRMSBAG01 **NEW**

- Robusta borsa in Nylon 600D per asta microfonica singola. Zip in metallo e due manici laterali per un trasporto agevole. Disponibile in nero. Dimensioni interne: 1050 x 110 x 110 mm.
- Tough nylon 600D bag for single microphone stand. Metal zip and two side handles for easy transport. Available in black. Inner dimensions: 1050 x 110 x 110 mm.

PRO165BK **NEW**

- Giraffa telescopica con snodo in alluminio pressofuso. Compatibile con tutte le aste microfoniche dritte che hanno filettatura 5/8. Disponibile in nero opaco.
- Telescopic boom with die-cast aluminium swivel joint. Compatible with all straight microphone stands that have 5/8 thread. Available in matte black.

RSM210

- Asta giraffa aggiuntiva completamente regolabile, compatibile con tutte le aste microfoniche PROEL. Disponibile in nero opaco (RSM210).
- Fully adjustable boom arm attachment, compatible with all PROEL microphone stands. Available in matt black finish (RSM210).

RSM225

- Leggio in metallo perforato per spartiti, compatibile con tutte le aste microfoniche PROEL. Disponibile in nero opaco (RSM225).
- Perforated music stand, compatible with all PROEL microphone stands. Available in matt black finish (RSM225).

RSM230

- Supporto in acciaio per cuffia, da fissare direttamente all'asta per microfono o leggio. Disponibile in nero opaco.
- Steel headphone stand, to be fixed directly to the microphone stand or music stand. Available in matt black.

RSM240

- Supporto universale poggia bevande in metallo. Può essere utilizzato su aste microfoniche, supporti per strumenti e leggio. Disponibile nella finitura nero opaco antigraffio.
- Universal holder for cans, glasses and bottles. Provided with universal clamp that allow it to be attached to microphone stands, music stands and instrument stands. Available in scratch-resistant matt black finish.

TECH INFO

| Model: | RSM210 | RSM225 |
|------------------------|--------------------|-------------------------------|
| Maximum height: | 475 mm (18.70") | 615 mm (24.21")* |
| Weight: | 3.95 kg (8.71 lbs) | 4.10 kg (9.04 lbs) |
| Available colors: | Black | Black |
| Master Carton: | 1 pc. | 10 pcs. |
| Boom length: | 690 mm (27.17") | -- |
| Music sheet dimension: | -- | 240 x 315 mm (9.44" x 12.40") |

MICROPHONE STAND ACCESSORIES

METAL SYSTEM



PROIPS03

PROIPS04

RSM445

RSM445 **NEW**

- Piano portaoggetti rettangolare in acciaio, dotato di rivestimento in foam sul piano per una maggiore tenuta degli oggetti. Dimensioni del piano di appoggio: 350 * 120 mm. Disponibile in nero opaco.
- Rectangular steel, equipped with foam pad lining on the top for a better hold of the objects. Dimensions of the support surface: 350 * 120 mm. Available in matte black finish.

PROIPS03

- Supporto universale Proel per tablet, realizzato in metallo ed abs. Il PROIPS03 ha caratteristiche simili al PROIPS02, ma può essere utilizzato solo per montaggio su aste microfoniche e/o altre tipologie di supporti, per mezzo del morsetto che può essere agganciato a tubi dal diametro minimo di 14 mm fino ad un massimo di 25mm. Questo supporto offre innumerevoli regolazioni con libertà d'uso e leggibilità ottimali durante le esibizioni live. Colore nero opaco
- Proel universal tablet holder, made by steel and ABS. The PROIPS03 has features similar to PROIPS02, but can only be used for mounting on microphone stands and / or other types of stands, using the clamp which may be coupled to tubing from the minimum diameter of 14 mm up to a maximum of 25mm. This stand offers numerous adjustments with freedom of use and optimal readability during live performances. Matt black color.

PROIPS04

- Supporto universale Proel per smartphone e tablet. Montato sull'asta microfonica, il supporto offre innumerevoli regolazioni con libertà d'uso e leggibilità ottimali durante le esibizioni live. Il prodotto è dotato di: supporto regolabile in materiale plastico ricoperto in gomma antigraffio; morsetto di aggancio realizzato in alluminio pressofuso. Può essere montato su asta microfonica o scrivania (fino a 25 mm di spessore) ed ha un'orientabilità illimitata. Colore nero con parti in colore argento (asta e morsetto). Può essere usato per dispositivi con dimensioni da 4,7" fino a 12,9", con una larghezza da 90 fino a 233 mm.
- Proel universal smartphone and tablet stand. Attached on the microphone stand, it offers several adjustments with freedom of use and optimal readability during live performances. It featuring non-scratch rubber covered plastic stand; clamp coupling made of die-cast aluminum. Suitable for mounting on a microphone stand, or desk (up to 25 mm thickness) and has unlimited adjustability. Black color with parts in silver (arm and clamp). It can be used for devices with sizes from 4.7 "up to 12.9", with a width from 90 up to 233 mm.



PROIPS03

RSM445

PROIPS04

DESKTOP MICROPHONE STANDS "DST" SERIES

METAL SYSTEM

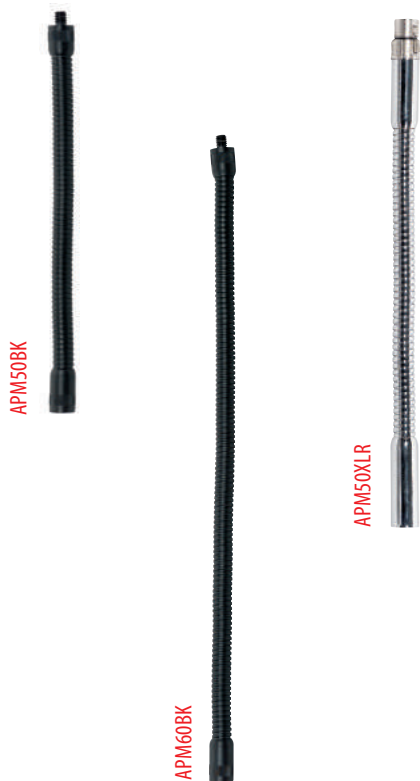

APM50BK

- Flessibile in metallo con filettature 3/8" - 5/8" maschio/femmina. Dimensioni: Ø 15 x 300 mm. Disponibile in nero opaco (APM50BK). Confezione standard 1 pezzo.
- Metal gooseneck with 3/8" - 5/8" male/female thread. Dimension: Ø 15 mm x 300 mm. Available in matt black (APM50BK) finish. Master pack: 1 pc.

APM60BK

- Flessibile in metallo con filettature 3/8" - 5/8" maschio/femmina. Dimensioni: Ø 15 x 500 mm. Disponibile in nero opaco (APM60BK). Confezione standard 1 pezzo.
- Metal gooseneck with 3/8" - 5/8" male/female thread. Dimension: Ø 15 mm x 500 mm. Available in matt black (APM60BK) finish. Master pack: 1 pc.

APM50XLR

- Flessibile in metallo con connettori XLR a 3 poli maschio/femmina incorporati. Dimensioni: Ø 15 x 300 mm. Confezione standard 1 pezzo.
- Metal gooseneck fitted with XLR 3-pole male/female connectors. Dimensions: Ø 15 mm x 300 mm. Master pack: 1 pc.



DST100

- Base da tavolo triangolare in ghisa pesante con adattatore universale APM40. Disponibile in nero opaco (DST100).
- Triangular desktop heavy cast iron base with APM40 universal adapter. Available in matt black (DST100) finish.

DST110BK - DST110

- Base da tavolo triangolare in ghisa pesante con asta telescopica. Disponibile in nero opaco (DST110BK) e cromata (DST110).
- Triangular desktop heavy cast iron base with telescopic boom. Available in matt black (DST110BK) and chrome plated (DST110) finish.

| TECH INFO | | |
|-------------------|------------------------------|-------------------------------------|
| Model: | DST100 | DST110BK/DST110 |
| Base Dimension: | 180 x 185 mm (7.09" x 7.28") | 180 x 185 mm (7.09" x 7.28") |
| Minimum height: | -- | 400 mm (15.75") |
| Maximum height: | 45 mm (1.77") | 560 mm (22.05") |
| Weight: | 2.50 kg (5.51 lbs) | 3.06 kg (6.75 lbs) |
| Available colors: | Black | Black (DST110BK) Chrome (DST110) |
| Boom length: | -- | 330 mm/490 mm (12.99"/19.29") |
| Master Carton: | 10 pcs. | 6 pcs. |



DESKTOP MICROPHONE STANDS "DST" SERIES

METAL SYSTEM

DST60TL



DST60TL



DST40TL



DST260



DST40TL

- Base/supporto in nylon per microfono da tavolo completamente richiudibile fornito di adattatore universale. Disponibile in nero opaco (DST40TL).
- Desktop microphone stand, completely collapsible equipped with universal adapter. Available in matt black finish (DST40TL).

DST60TL

- Base/supporto in metallo per microfono da tavolo completamente richiudibile fornito con supporto per microfono in ABS e adattatore universale. Disponibile in nero opaco (DST60TL).
- Desktop microphone metal base/stand, completely collapsible. It comes with an ABS microphone clip and universal adapter. Available in matt black finish (DST60TL).

DST260

- Supporto professionale con braccio estensibile per microfono comprensivo di supporto fisso da tavolo e morsetto regolabile. Indicato per installazioni radiofoniche e sale doppiaggio. Cavo microfonico XLR - XLR da 5 metri incluso. Disponibile in nero opaco (DST260).
- Extensible arm microphone stand featuring fixed desktop base and clip-on base desktop stand. Suggested for radio installations and dubbing studios. 5 m XLR - XLR microphone cable included. Available in matt black (DST260) finish.

TECH INFO

| Model: | DST40TL | DST60TL | DST260 |
|-------------------|--------------------|--------------------|---------------------|
| Base Dimension: | Ø 90 mm (3.54") | Ø 210 mm (8.27") | -- |
| Minimum height: | -- | 160 mm (6.30") | 480 mm (18.90") |
| Maximum height: | 160 mm (6.30") | 210 mm (8.46") | 920 mm (36.23") |
| Weight: | 0.25 kg (0.55 lbs) | 0.31 kg (0,68 lbs) | 1.34 kg (2.96 lbs) |
| Available colors: | Black | Black | Black |
| Boom length: | -- | -- | 480 mm x 2 (18.90") |
| Master Carton: | 10 pcs. | 10 pcs. | 10 pcs. |

*Microphone, microphone holder and pop filter are not included

DESKTOP MICROPHONE STANDS "DST" SERIES

METAL SYSTEM



DST140BK



DST150BK



DST130BK

DST130BK

- Supporto da tavolo per microfono con base circolare in ghisa ed asta dritta. La base è dotata di anello antivibrazione. Diametro esterno della base 150 mm (5,90") - Altezza: 235 mm (9,25") / 365 mm (14,37"). Disponibile con finitura in nero opaco (DST130BK).
- Desktop heavy cast iron base with straight height adjustable tube. Featuring anti vibration rubber ring. Outer diameter 150 mm (5.90") - Height: 235 mm (9.25") / 365 mm (14.37"). Available in matt black finish (DST130BK).

DST140BK

- Asta nana professionale regolabile in altezza con giraffa fissa. Dotata di base in ghisa con anello inferiore in gomma antivibrazione. Diametro esterno della base 180 mm (7,09") - Altezza: 305 mm (12") / 435 mm (17,12"). Disponibile con finitura in nero opaco (DST140BK).
- Low-level height adjustable microphone stand with fixed boom. Featuring anti-vibration rubber ring iron cast base. Base diameter 180 mm (7.09") - Height: 305 mm (12") / 435 mm (17.12"). Available in matt black finish (DST140BK).

DST150BK NEW

- Asta nana doppia per microfono da tavolo, con giraffa regolabile lungo il tubo verticale e terminazioni con filettatura 3/8 (adattatori 5/8 inclusi). Dotata di base rotonda in acciaio ad elevata stabilità, con anello inferiore in gomma antivibrazione. Diametro esterno della base 180 mm (7,09") - Altezza: 280 mm (11,02") - Lunghezza giraffa: 280 mm (11,02"). Disponibile con finitura in nero opaco.
- Desktop low level double microphone stand, with adjustable boom along the vertical tube and 3/8 threaded terminations (5/8 adapters included). Equipped with high stability round steel base, with an anti-vibration rubber bottom ring. Base diameter 180 mm (7.09") - Height: 280 mm (11.02") - Boom length: 280 mm (11.02"). Available in matt black finish.

TECH INFO

| Model: | DST130BK | DST140BK | DST150BK |
|-------------------|--------------------|--------------------|--------------------|
| Base Dimension: | Ø 150 mm (5,90") | Ø 180 mm (7,09") | Ø 180 mm (7,09") |
| Minimum height: | 235 mm (9,25") | 305 mm (12,00") | - |
| Maximum height: | 365 mm (14,37") | 435 mm (17,12") | 280 mm (11,02") |
| Weight: | 1.90 kg (4,18 lbs) | 2.20 kg (4,85 lbs) | 1.60 kg (3,52 lbs) |
| Available colors: | Black | Black | Black |
| Boom length: | -- | 450 mm (17,71") | 280 mm (11,02") |
| Master Carton: | 6 pcs. | 6 pcs. | 10 pcs. |

MICROPHONE ACCESSORIES "APM" SERIES

METAL SYSTEM



APM10



APM20



APM25



APM20



APM15



APM30



APM35B



APM35S



APM45B



APM45S



APM10

- Supporto grande in ABS per microfono (Ø min - max: 22 - 26 mm).
- *Big ABS microphone holder (Ø Min-Max: 22 - 26 mm).*

APM20

- Supporto in gomma speciale per microfono (Ø min - max: 22 - 26 mm).
- *Special rubber microphone holder (Ø Min-Max: 22 - 26 mm).*

APM25

- Supporto in ABS per microfono (Ø min - max: 27 - 31 mm).
- *ABS microphone holder (Ø Min-Max: 27 - 31 mm).*

APM30

- Supporto a pinza in ABS per microfono (Ø min - max: 20 - 32 mm).
- *ABS microphone clip holder (Ø Min-Max: 20 - 32 mm).*

APM15

- Supporto universale a pinza in ABS con vite bloccante per microfono (Ø min - max: 20 - 32 mm).
- *Universal ABS microphone clip holder with fastening screw (Ø Min-Max: 20 - 32 mm).*

APM35S

- Supporto piccolo in ABS per microfono (Ø min - max: 22 - 27 mm).
- *Small ABS microphone holder (Ø Min-Max: 22 - 27 mm).*

APM35B

- Supporto grande in ABS per microfono (Ø min - max: 30 - 35 mm).
- *Big ABS microphone holder (Ø Min-Max: 30 - 35 mm).*

APM45S

- Supporto piccolo professionale in ABS per microfono (Ø min - max: 18 - 22 mm).
- *Small professional ABS microphone holder (Ø Min-Max: 18 - 22 mm).*

APM45B

- Supporto grande professionale in ABS per microfono (Ø min - max: 32 - 39 mm).
- *Big professional ABS microphone holder (Ø Min-Max: 32 - 39 mm).*

MICROPHONE ACCESSORIES "APM" SERIES

METAL SYSTEM



APM40

- Adattatore universale 5/8" - 3/8" per supporti microfonici. Confezione standard 12 pezzi.
- 5/8" - 3/8" universal screw adapter for microphone stands. Master pack: 12 pcs.

AP122

- Adattatore universale 3/8" - 5/8" per supporti microfonici. Confezione standard 6 pezzi.
- 3/8" - 5/8" universal adapter. Master pack: 6 pcs.

AP114

- Adattatore universale per videocamere, registratori digitali, "action cameras" ed altri dispositivi con vite 1/4". Adatto per il montaggio su aste microfoniche con filettatura 5/8" standard. Ampie regolazioni possibili. Disponibile in finitura cromata.
- Universal adapter for cameras, digital recorders, "action cameras" and other devices with 1/4" screw. Suitable for mounting on a mic stand with standard 5/8" thread. Broadest possible adjustments. Available in chrome finish.

APM47

- Supporto in ABS a pinza regolabile per microfono, ideale per microfonare la batteria. Sull'APM47 possono essere applicati tutti i supporti per microfono PROEL.
- ABS microphone holder with fixing clip, ideal for drum microphoning. On the APM47 can be applied all PROEL microphone holders.

APM215

- Supporto professionale anti-vibrazione con doppia molla elastica e guaina protettiva per microfono a condensatore (Ø min - max: 22 - 24 mm). Confezione standard 1 pezzo.
- Professional shock mount holder with double elastic spring and protective cover for condenser microphone (Ø Min - Max: 22 - 24 mm). Master pack: 1 pc.

APM225

- Supporto professionale anti-vibrazione con doppia molla elastica e guaina protettiva per microfono a condensatore (Ø min - max: 44 - 48 mm). Confezione standard 1 pezzo.
- Professional shock mount holder with double elastic spring and protective cover for condenser microphone (Ø Min - Max: 44 - 48 mm). Master pack: 1 pc.

MICROPHONE ACCESSORIES "APM" - "WS" SERIES

METAL SYSTEM



APM65

- Supporto aggiuntivo in metallo per asta microfonica, dotato di flessibile con filettatura standard 5/8" di lunghezza 30 cm. Disponibile in nero opaco (APM65).
- Additional metal bracket for microphone stand, equipped with 5/8" thread and 30 cm length gooseneck. Available in matt black finish (APM65).

APM72

- Supporto in acciaio con aggancio per 2 supporti microfonici da utilizzare su aste diritte. Lunghezza: 180 mm. Confezione standard 1 pz.
- Steel bar with connection for 2 microphone holders to use on straight stands. Length: 180 mm. Master pack: 1pc.

APM74

- Supporto in acciaio con aggancio per 4 supporti microfonici da utilizzare su aste diritte. Lunghezza: 300 mm. Confezione standard 1 pz.
- Steel bar with connection for 4 microphone holders to use on straight stands. Length: 300 mm. Master pack: 1pc.

WS6BK- WS6

- Set di n° 6 coperture universali in spugna per microfono. Dimensioni interne: Ø 35 x 70 mm. Modelli disponibili: WS6 - 6 colori • WS6BK - solo nero. Confezione standard: 1 set.
- 6 universal microphone sponge windscreen set. Inner dimensions: Ø 35 mm x 70 mm. Available models: WS6 - 6 colours • WS6BK: black only. Master pack: 1 set.

WS6MBK

- Set di n° 6 coperture universali in spugna per microfono. Dimensioni interne: Ø 25 x 65 mm. Modelli disponibili: WS6MBK - solo nero. Confezione standard: 1 set.
- 6 universal microphone sponge windscreen set. Inner dimensions: Ø 25 mm x 65 mm. Available models: WS6MBK: black only. Master pack: 1 set.

WS1BK

- Copertura grande in spugna per microfono. Dimensioni interne: Ø 45 x 115 mm. Colore: nero. Confezione standard: 1 pezzo.
- Big microphone sponge windscreen. Inner dimension: Ø 45 mm x 115 mm. Colour: black. Master pack: 1 pc.

WS2BK

- Set di n° 2 coperture piccole in spugna per microfono head-mount. Dimensioni interne: Ø 10 x 25 mm. Colore: nero. Confezione standard: 1 set.
- Small head-mount microphone sponge windscreen set. Inner dimensions: Ø 10 mm x 25 mm. Colour: black. Master pack: 1 set.

MICROPHONE ACCESSORIES "APOP" - "PRO" SERIES

METAL SYSTEM

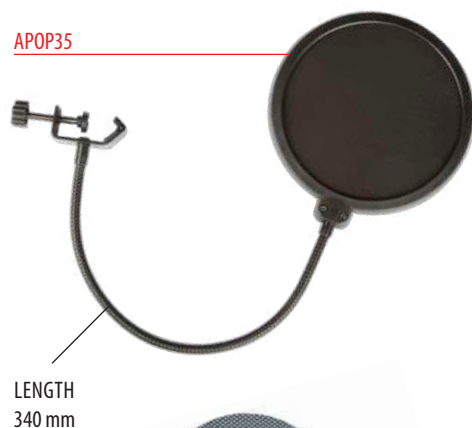

APOP30 **NEW**

- Mini filtro curvo antipop in metallo, con flessibile regolabile di lunghezza 29 cm. Dotato di morsetto di aggancio universale per tubi fino a 25 mm di diametro. Colore nero.
- Mini curved pop-filter in metal, with 29 cm length adjustable gooseneck. Equipped with universal clamp for pipes up to 25 mm in diameter. Black colour.

APOP35 **NEW**

- Filtro antisibilo doppio a calza in nylon, con flessibile regolabile di lunghezza 34 cm. Diametro del filtro 155 mm. Dotato di morsetto di aggancio universale per tubi fino a 25 mm di diametro. Colore nero.
- Dual layer nylon screen pop filter, equipped with 34 cm length adjustable gooseneck. Filter diameter 155 mm. Equipped with universal clamp for pipes up to 25 mm in diameter. Black colour.

APOP40

- Supporto mini con filtro antisibilo in metallo con flessibile regolabile. Dotato di piastra di aggancio universale per aste diritte. Colore nero.
- Metal screen mini pop filter, equipped with adjustable gooseneck and universal mounting plate for straight microphone stands. Black colour.

APOP50

- Supporto con filtro antisibilo a calza in nylon con flessibile regolabile. Dotato di piastra di aggancio universale per aste diritte. Colore nero.
- Dual layer nylon screen pop filter, equipped with adjustable gooseneck and universal fastening screw for straight stands. Black colour.

APOP65

- Supporto con filtro antisibilo staccabile a calza in nylon con flessibile regolabile. Dotato di pinza di aggancio universale in nylon. Colore nero.
- Nylon screen pop filter equipped with adjustable gooseneck and universal orientable/adjustable clip with fastening screw, detachable head. Black colour.

PRORF02

- Leggero schermo acustico per studio di registrazione oppure per "home-studio". Lo schermo migliora il suono dello spazio acustico attorno al microfono. Dotato di un inserto in metallo universale da 5/8" per essere installato su supporti microfoniche dritti. Confezione standard: 1 pezzo.
- Lightweight recording/home studio acoustic diffuser screen. The screen improves the sound of the acoustic space around the microphone. The screen has a metal insert with universal 5/8" thread to be attached to a straight microphone stand. Master pack: 1 pc.

PRORF02



KEYBOARD STANDS "SNAP LOCK SYSTEM" SERIES

METAL SYSTEM



• Add - on tiers and accessories – Page 29

SPL100

- Supporto per tastiera ad un solo livello con sistema di regolazione "SNAP LOCK". Convertibile in supporto a due livelli usando l'articolo KB400. Disponibile in grigio antracite.
- "SNAP LOCK" adjustment system one-tier keyboard stand. It can be converted into a two-tier stand by using the KB400 add-on tier. Available in anthracite grey.

SPL150

- Supporto professionale per tastiera a singolo livello con sistema di regolazione "SNAP LOCK". Convertibile in supporto a due livelli usando l'articolo EL450. Disponibile in grigio antracite.
- "SNAP LOCK" adjustment system professional one-tier keyboard stand. It can be converted into a two-tier stand by using the EL450 add-on tier. Available in anthracite grey.

SPL250

- Supporto professionale per tastiera a singolo livello con doppio telaio e sistema di regolazione "SNAP LOCK". Convertibile in supporto a due livelli usando l'articolo EL450. Disponibile in grigio antracite.
- "SNAP LOCK" adjustment system professional one-tier keyboard stand, double frame design. It can be converted into a two-tier stand by using the EL450 add-on tier. Available in anthracite grey.

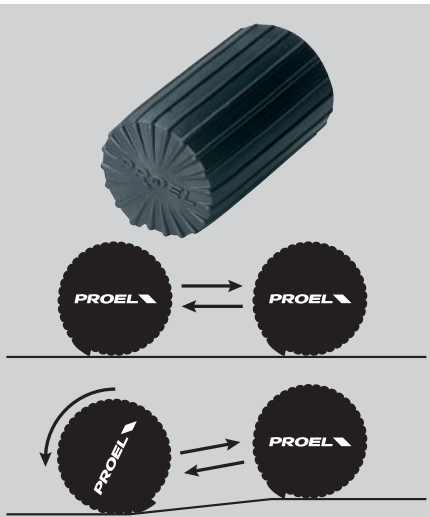

| TECH INFO | | | |
|-------------------|--------------------|--------------------|---------------------|
| Model: | SPL100 | SPL150 | SPL250 |
| Minimum height: | 560 mm (22.05") | 560 mm (22.05") | 560 mm (22.05") |
| Maximum height: | 970 mm (38.19") | 970 mm (38.19") | 970 mm (38.19") |
| Upper arms depth: | 400 mm (15.75") | 400 mm (15.75") | 400 mm (15.75") |
| Weight: | 3.70 kg (8.16 lbs) | 4.20 kg (9.26 lbs) | 6.00 kg (13.23 lbs) |
| Available colors: | Anthracite grey | Anthracite grey | Anthracite grey |
| Maximum load: | 40 kg (88.18 lbs) | 50 kg (110.23 lbs) | 80 kg (176.37 lbs) |
| Master Carton: | 5 pcs. | 5 pcs. | 5 pcs. |

KEYBOARD STANDS "SNAP LOCK SYSTEM" SERIES

METAL SYSTEM



SPL152

- Supporto professionale per tastiera a due livelli con sistema di regolazione "SNAP LOCK". Disponibile in grigio antracite.
- "SNAP LOCK" adjustment system two-tier keyboard stand. Available in anthracite grey.

SPL252

- Supporto professionale per tastiera a due livelli con doppio telaio e sistema di regolazione "SNAP LOCK". Disponibile in grigio antracite.
- "SNAP LOCK" adjustment system professional two-tier keyboard stand, double frame design. Available in anthracite grey.

SPL253

- Supporto professionale per tastiera a tre livelli con doppio telaio e sistema di regolazione "SNAP LOCK". Disponibile in grigio antracite.
- "SNAP LOCK" adjustment system professional three-tier keyboard stand, double frame design. Available in anthracite grey.

• Add - on tiers and accessories – Page 29



ELPIANO

TECH INFO

| Model: | SPL152 | SPL252 | SPL253 |
|-------------------|---------------------|---------------------|----------------------|
| Minimum height: | 560 mm (22.05") | 560 mm (22.05") | 560 mm (22.05") |
| Maximum height: | 970 mm (38.19") | 970 mm (38.19") | 970 mm (38.19") |
| First tier depth: | 400 mm (15.75") | 400 mm (15.75") | 400 mm (15.75") |
| Other tier depth: | 330 mm (12.99") | 330 mm (12.99") | 330 mm (12.99") |
| Weight: | 6.90 kg (15.21 lbs) | 9.00 kg (19.84 lbs) | 11.80 kg (26.01 lbs) |
| Available colors: | Anthracite grey | Anthracite grey | Anthracite grey |
| Maximum load: | 50 kg (110.23 lbs) | 80 kg (176.36 lbs) | 90 kg (198.41 lbs) |
| Master Carton: | 1 pc. | 1 pc. | 1 pc. |

KEYBOARD STANDS "EASY LOCK SYSTEM" SERIES

METAL SYSTEM

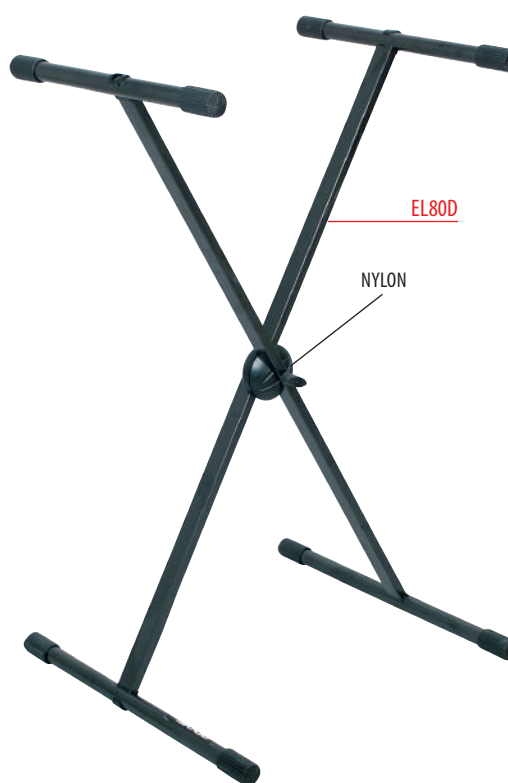
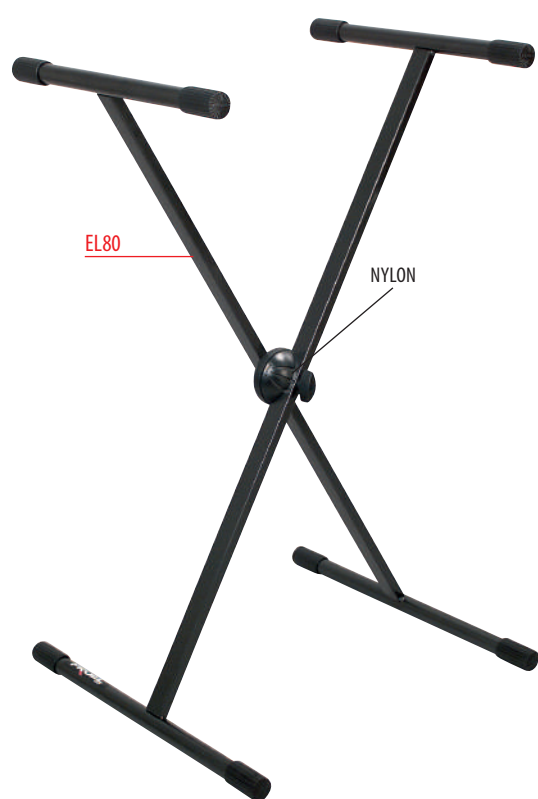

EL80D

- Supporto per tastiera a singolo livello con sistema di regolazione "EASY LOCK" in Nylon. Completamente smontabile e facilmente ripiegabile. Disponibile in grigio antracite.
- "EASY LOCK" adjustment system one-tier keyboard stand, fully removable and easily foldable. Available in anthracite grey.

EL80

- Supporto per tastiera a singolo livello con sistema di regolazione "EASY LOCK" in Nylon. Disponibile in grigio antracite.
- "EASY LOCK" adjustment system one-tier keyboard stand. Available in anthracite grey.

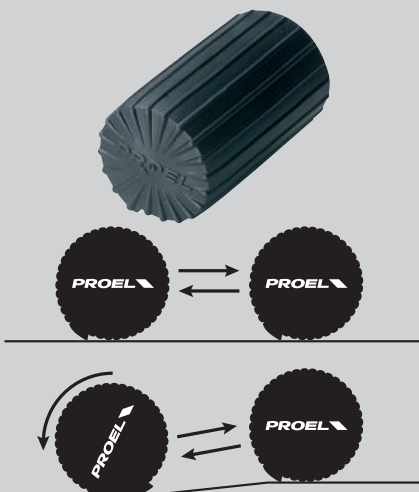

TECH INFO

| Model: | EL80D | EL80 |
|-------------------|----------------------|--------------------|
| Minimum height: | 560 mm (22.05") | 560 mm (22.05") |
| Maximum height: | 970 mm (38.19") | 970 mm (38.19") |
| Upper arms depth: | 400 mm (15.75") | 400 mm (15.75") |
| Weight: | 3.60 kg (7.94 lbs) | 3.45 kg (7.61 lbs) |
| Available colors: | Anthracite grey | Anthracite grey |
| Maximum load: | 40.00 kg (88.18 lbs) | 40 kg (88.18 lbs) |

KEYBOARD STANDS "EASY LOCK SYSTEM" SERIES

METAL SYSTEM

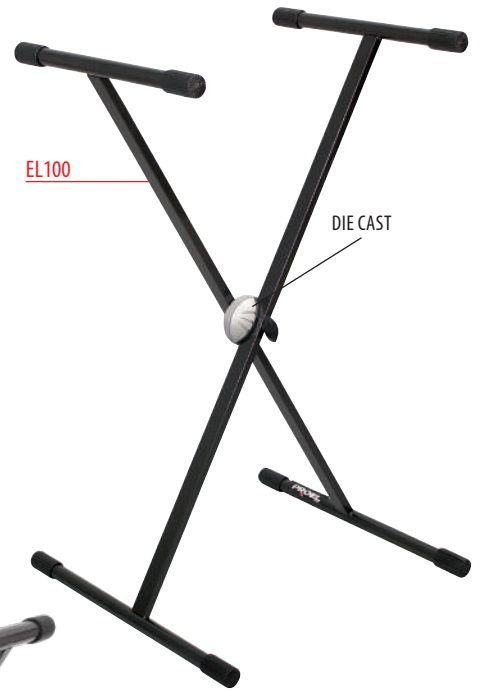

• Add - on tiers and accessories – Page 29



EL450 - KB400



ELPIANO

EL100

• Supporto professionale per tastiera a singolo livello con sistema di regolazione "EASY LOCK" in alluminio pressofuso. Convertibile in un supporto a due livelli con l'aggiunta dell'articolo KB400. Disponibile in grigio antracite.
 • "EASY LOCK" adjustment system professional one-tier keyboard stand. It can be converted into a two-tier stand by using the KB400 add-on tier. Available in anthracite grey.

EL250

• Supporto professionale per tastiera a singolo livello con doppio telaio in acciaio verniciato e sistema di regolazione "EASY LOCK" in alluminio pressofuso. Convertibile in un supporto a due livelli con l'aggiunta dell'articolo EL450. Disponibile in grigio antracite.
 • "EASY LOCK" adjustment system professional one-tier keyboard stand, double frame design. It can be converted into a two-tier stand by using the EL450 add-on tier. Available in anthracite grey.

TECH INFO

| Model: | EL100 | EL250 |
|-------------------|--------------------|---------------------|
| Minimum height: | 560 mm (22.05") | 560 mm (22.05") |
| Maximum height: | 970 mm (38.19") | 970 mm (38.19") |
| Upper arms depth: | 400 mm (15.75") | 400 mm (15.75") |
| Weight: | 3.80 kg (8.38 lbs) | 6.00 kg (13.23 lbs) |
| Available colors: | Anthracite grey | Anthracite grey |
| Maximum load: | 40 kg (88.18 lbs) | 80 kg (176.37 lbs) |
| Master Carton: | 5 pcs. | 5 pcs. |

KEYBOARD STANDS "TABLE" SERIES

METAL SYSTEM



EL260



EL260



EL270



EL270



EL260



EL270

EL260

• Supporto universale per tastiera richiudibile con altezza e lunghezza regolabili munito di secondo livello a bracci inclinabili. Grazie al meccanismo "EASY LOCK", la regolazione dei bracci del secondo livello è semplice ed accurata. La costruzione dell' EL260 permette la regolazione dell'allungamento del piano grazie ad un sistema di tubi scorrevoli. Disponibile in nero opaco.

• Universal folding width/height adjustable keyboard stand with adjustable 2nd tier. Thanks to its "EASY LOCK" mechanism, tiers adjustment is simple and accurate. EL260's design allows width adjustment of the stand thanks to its sliding tube structure. Available in matt black.

EL270

• Supporto universale per piani digitali e tastiere, realizzato con tubolari in acciaio a sezione quadrata. Larghezza ed altezza regolabili. Le posizioni in altezza sono predefinite e ad alta stabilità, grazie ad un sistema di fissaggio con inserti filettati presenti nei tubi scorrevoli. Dotato di pratico foam per la copertura delle superfici di appoggio superiore. Disponibile in nero opaco.

• Universal support for digital pianos and keyboards, made with square section steel tubes. Adjustable width and height. The height positions are predefined and highly stable, thanks to a fixing system with threaded inserts present in the sliding tubes. Equipped with practical foam to cover the upper support surfaces. Available in matt black.

TECH INFO

| Model: | EL260 | EL270 |
|-------------------|---------------------------|----------------------------|
| Height | 720/860 mm (28.34/33.86") | 620/790 mm (24.41/31.10") |
| Width: | 660/950 mm (25.98/37.40") | 710/1020 mm (27.95/40.16") |
| Depth: | 490 mm (19.29 lbs) | 320 mm (12.60"): |
| Upper arms depth: | 330 mm (15.75") | -- |
| Weight: | 12.85 kg (28.33 lbs) | 8.90 kg (19.62 lbs) |
| Available colors: | Black | Black |
| Maximum load: | 120 kg (264.55 lbs) | 80 kg (176.37 lbs) |
| Master Carton: | 1 pc. | 1 pc. |

KEYBOARD STANDS "TABLE" SERIES

METAL SYSTEM



EL290



EL290

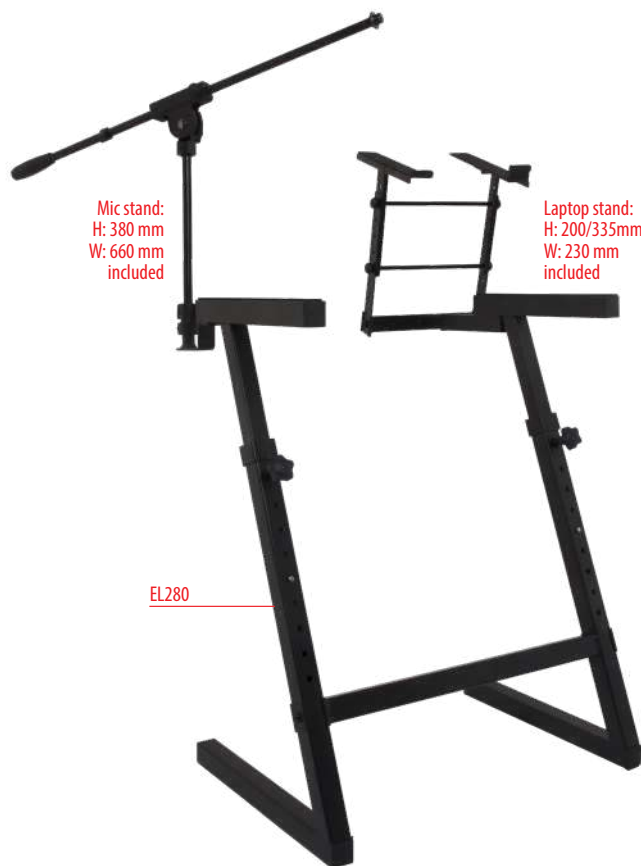

Mic stand:
H: 380 mm
W: 660 mm
included

Laptop stand:
H: 200/335mm
W: 230 mm
included

EL280

EL280

• Supporto professionale regolabile per tastiera, realizzato in acciaio. Può essere utilizzato anche per il posizionamento di apparati per DJ. Si compone di una struttura di base a larghezza fissa (600 mm) regolabile in altezza. Dotato di asta microfonica ad altezza fissa con giraffa regolabile e supporto per computer regolabile in altezza. Disponibile nel colore nero opaco.

• Professional adjustable keyboard stand, manufactured in steel. It can also be used for DJ's equipment. It consists of a fixed width (600 mm) base structure, height adjustable. Equipped with a microphone stand with fixed height and adjustable boom and with height adjustable laptop stand. Available in matt black finish.

EL280

EL290 NEW

• Supporto universale per piani digitali con altezza e lunghezza regolabili grazie ad un sistema di tubi scorrevoli. Dotato di pratico foam per la copertura delle superfici di appoggio superiore. Disponibile in nero opaco.

• Universal folding width/height adjustable keyboard stand for digital pianos. Equipped with practical foam to cover the upper support surfaces. Available in matt black.



TECH INFO

| | EL280 | EL290 |
|--------------------------|----------------------------|-----------------------------|
| Model: | EL280 | EL290 |
| Height: | 590/840 mm (23.22"/33.07") | 670/780 mm (26.38"/30.71") |
| Width: | 600 mm (23.62") | 720/1007 mm (28.35"/39.65") |
| Depth: | 400 mm (15.74") | 320 mm (12.60") |
| Upper arms depth: | 300 mm (11.81") | - |
| Weight: | 7.30 kg (16.09 lbs) | 6.08 kg (14.99 lbs) |
| Available colors: | Black | Black |
| Maximum load: | 30 kg (132.27 lbs) | 50 kg (110.23 lbs) |
| Master Carton: | 1 pc. | 1 pc. |

KEYBOARD STAND ACCESSORIES

METAL SYSTEM



EL450

KB400

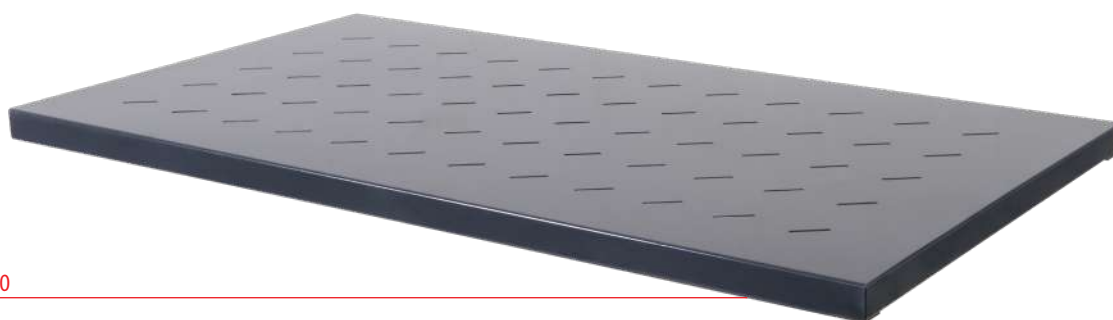

ELPIANO

ELPIANO

- Mensola preforata realizzata in acciaio verniciato, idonea per tutti i supporti per tastiera PROEL. Dimensioni del piano 800 x 500 mm. Disponibile in grigio antracite.

- Grill painted steel shelf, suitable for all PROEL keyboard stands. Supporting surface size: 800 mm x 500 mm. Available in anthracite grey.

EL450

- Supporto aggiuntivo con meccanismo "EASY LOCK", completamente regolabile, molto stabile e sicuro. Utilizzabile solo con i supporti PROEL EL250 - SPL150 - SPL250. Diametro dei tubi 28 mm. Disponibile in grigio antracite.

- Add-on tier with "EASY LOCK" mechanism, fully adjustable, very stable and safe. Suitable for PROEL EL250-SPL150-SPL250 stands only. Tube diameter: 28 mm. Available in anthracite grey.

KB400

- Supporto aggiuntivo con meccanismo "EASY LOCK", completamente regolabile, molto stabile e sicuro. Utilizzabile solo con i supporti PROEL EL100 - SPL100. Diametro dei tubi 25 mm. Disponibile in grigio antracite.

- Add-on tier with "EASY LOCK" mechanism, fully adjustable, very stable and safe. Suitable for PROEL EL100-SPL100 stands only. Tube diameter: 25 mm. Available in anthracite grey.

TECH INFO

| Model: | ELPIANO | KB400/EL450 |
|-------------------|---------------------|--------------------|
| Height: | 27 mm (1.06") | 300 mm (11.81") |
| Width: | 820 mm (32.28") | -- |
| Depth: | 463 mm (18.22") | 330 mm (12.99") |
| Weight: | 6.00 kg (13.23 lbs) | 2.60 kg (5.73 lbs) |
| Available colors: | Anthracite grey | Anthracite grey |
| Maximum load: | -- | 40 kg (88.18 lbs) |
| Master Carton: | 2 pcs. | 1 pc. |

GUITAR STANDS "FC" SERIES

METAL SYSTEM



FC80

• Supporto con braccia universali per basso/chitarra elettrica e chitarra classica/acustica. Tutte le estremità sono ricoperte in foam per la protezione dello strumento. Non indicati per strumenti con verniciatura "nitro". Disponibile in grigio antracite.
 • *Electric bass/guitar and classic/acoustic guitar stand with universal arms. All ends are foam covered for instrument protection. Not recommended for "nitro" lacquered guitars. Available in anthracite grey.*

FC100

• Supporto per basso/chitarra elettrica. Tutte le estremità sono ricoperte in foam per la protezione dello strumento. Non indicati per strumenti con verniciatura "nitro". Disponibile in grigio antracite.
 • *Electric bass/guitar stand. All ends are foam covered for instrument protection. Not recommended for "nitro" lacquered guitars. Available in anthracite grey.*

FC200

• Supporto per chitarra classica/acustica. Tutte le estremità sono ricoperte in foam per la protezione dello strumento. Non indicati per strumenti con verniciatura "nitro". Disponibile in grigio antracite.
 • *Classic/acoustic/folk guitar/bass stand. All ends are foam covered for instrument protection. Not recommended for "nitro" lacquered guitars. Available in anthracite grey.*

FC705 NEW

• Supporto universale per basso/chitarra elettrica e chitarra classica/acustica con braccia universali e collare di protezione per il manico. Tutte le estremità sono ricoperte in foam per la protezione dello strumento. Non indicato per strumenti con verniciatura "nitro". Disponibile in nero.
 • *Low profile solid universal guitar stand for classic, acoustic/folk and electric guitars. All ends are foam covered for instrument protection. Not recommended for nitro lacquered guitars. Available in black.*

TECH INFO

| Model: | FC80/FC100/FC200 | FC705 |
|-------------------|--------------------|---------------------------|
| Height: | 380 mm (14.96") | 620/720 mm (24.41/28.35") |
| Width: | 320 mm (12.60") | 530 mm (20.87") |
| Depth: | 295 mm (11.61") | 310 mm (12.20") |
| Weight: | 1.15 kg (2.53 lbs) | 1.00 kg (2.20 lbs) |
| Available colors: | Anthracite grey | Black |
| Maximum load: | 6 kg (13.23 lbs) | 8.00 kg (17.64 lbs) |
| Master carton: | 10 pcs. | 10 pcs. |



GUITAR STANDS "FC" SERIES

METAL SYSTEM



FC720

- Supporto universale per basso/chitarra elettrica e chitarra classica/acustica con braccia universali e collare di protezione per il manico. Tutte le estremità sono ricoperte in gomma per la protezione dello strumento. Disponibile in grigio antracite.
- Stand with universal arms and neck protection collar for electric and classic/ acoustic guitar/bass. All ends are rubber-coated for instrument protection. Available in anthracite grey.

FC820

- Supporto universale doppio per basso/chitarra elettrica e chitarra classica/acustica con braccia universali collare di protezione per il manico. Tutte le estremità sono ricoperte in gomma per la protezione degli strumenti. Disponibile in grigio antracite.
- Double stand with universal arms and neck protection collar for electric and classic/acoustic bass/guitar. All ends are rubber-coated for instrument protection. Available in anthracite grey.

TECH INFO

| Model: | FC720 | FC820 |
|-------------------|---------------------------|---------------------------|
| Height: | 500/800 mm (19.69/31.50") | 500/800 mm (19.69/31.50") |
| Width: | 320 mm (12.60") | 320 mm (12.60") |
| Depth: | 300 mm (11.81") | 400 mm (15.75") |
| Weight: | 1.76 kg (3.88 lbs) | 2.20 kg (4.85 lbs) |
| Available colors: | Anthracite grey | Anthracite grey |
| Maximum load: | 10.00 kg (22.05 lbs) | 20.00 kg (44.09 lbs) |
| Master Carton: | 5 pcs. | 5 pcs. |



GUITAR STANDS "FC" SERIES

METAL SYSTEM



FC830N - FC850N - FC870N

• Serie di supporti universali pieghevoli, realizzati in acciaio, per l'alloggiamento multiplo di chitarre (classiche/acustiche/elettriche) e bassi. Le superfici di contatto, sono realizzate con morbido materiale espanso che assicura la giusta protezione degli strumenti. Sono disponibili tre versioni, rispettivamente per 3, 5 e 7 chitarre. Colore nero opaco antigraffio.

• Series of universal steel made folding stands, to accommodate multiple guitars (classical / acoustic / electric) and bass. The contact surfaces are made of soft foam material that ensures protection of the instruments. Three versions are available, respectively, for 3, 5 and 7 guitars. Matt black scratch-resistant finishing.

TECH INFO

| Model: | FC830N/FC850N/FC870N |
|-------------------|--|
| Height: | 730 mm (28.74") |
| Width: | 465 mm (18.30") / 685 mm (26.96") / 905 mm (35.63") |
| Depth: | 430 mm (16.93") |
| Weight: | 2.04 kg (4.85 lbs) / 2.44 kg (5.37 lbs) / 2.84 kg (6.26 lbs) |
| Available colors: | Black |
| Master Carton: | 1 pc. |
| Note: | Guitar support base depth: 270 mm (10.63") |

GUITAR HANGER & FOOT REST "FC" SERIES

METAL SYSTEM



FC600



FC600



FC510

FOAM COVERED

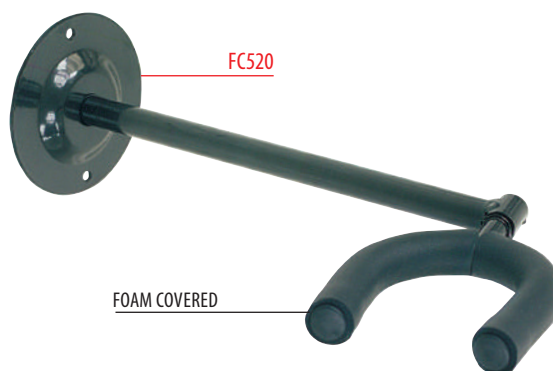

FC520

FOAM COVERED



FC510



FC520

FC600

- Poggiapiedi ripiegabile per chitarristi. Altezza regolabile in quattro posizioni. Superficie in gomma antiscivolo. Disponibile in nero opaco (FC600).
- Folding footrest for guitarist. 4 position - height adjustable. Non-skid rubber top. Available in matt black finish.

FC510

- Supporto a muro per chitarra elettrica/acustica. Colletto gommato per la protezione dello strumento. Ideale per esposizione in negozio o in fiere. Disponibile in grigio antracite.
- Wall-mount hanger for electric/acoustic guitar. Rubber-coated collar for instrument protection. Recommended for shop or exhibition display. Available in anthracite grey.

FC520

- Supporto a muro per chitarra elettrica/acustica regolabile a 33° gradi. Colletto gommato per la protezione dello strumento. Ideale per esposizione in negozio o in fiere. Disponibile in grigio antracite.
- 33°-adjustable wall-mount hanger for electric/acoustic guitar. Rubber-coated collar for instrument protection. Recommended for shop or exhibition display. Available in anthracite grey.

TECH INFO

| Model: | FC600 | FC510 | FC520 |
|-------------------|-------------------------|---------------------|--------------------|
| Height: | 106/200 mm (4.17/7.87") | -- | -- |
| Width: | 105 mm (4.13") | -- | -- |
| Depth: | 250 mm (9.84") | 130 mm (5.12") | 300 mm (11.81") |
| Weight: | 0.652 kg (1.43 lbs) | 0.320 kg (0.70 lbs) | 0.85 kg (1.87 lbs) |
| Available colors: | Black | Anthracite grey | Anthracite grey |
| Master Carton: | 20 pcs. | 10 pcs. | 10 pcs. |

MIXER STANDS "KS" SERIES

METAL SYSTEM



KS300

• Supporto robusto dal design innovativo, fornito di regolazione a barre incrociate. La larghezza arriva fino a 540 mm e le barre di supporto hanno un'inclinazione di 10 gradi; si monta e si ripiega in modo da poter essere riposto e trasportato facilmente. Disponibile in nero opaco.

• *Sturdy stand, innovative design, features a crossed bar-adjustment. Width gets to 540 mm and supporting bars are 10 degrees tilted; it can be set up and folded up for easy storage and transport. Available in matt black.*

KS350

• Nuovo supporto a "Z" per mixer / tastiera, realizzato in acciaio tubolare. Regolabile in larghezza ed altezza. Disponibile in nero opaco.

• *"Z" style mixer / keyboard stand, made by steel tube. Width and height fully adjustable. Available in matt black.*

TECH INFO

| Model: | KS300 | KS350 |
|-------------------|-----------------------------|----------------------------|
| Width: | 350/540 mm (13.78 - 21.26") | 570/970 mm (22.44"/38.18") |
| Height: | 800 mm (31.50") | 650/950 mm (25.59"/37.40") |
| Depth: | 490 mm (19.30") | 550 mm (21.65") |
| Usable depth: | 480 mm (18.90") | 400 mm (15.74") |
| Weight: | 8.0 kg (17.64 lbs) | 5.8 kg (12.78 lbs) |
| Maximum load: | 80.00 kg (176.37 lbs) | 60 kg (132.27 lbs) |
| Available colors: | Black | Black |
| Master Carton: | 4 pcs. | 5 pcs. |

AMPLIFIER AND MONITOR STANDS "EASY LOCK" SERIES

METAL SYSTEM



EL700

FOLDABLE ARMS



EL700

DIE CAST

EL680



EL620



EL620

- Supporto per monitor di riferimento, ideale per il perfetto posizionamento acustico di casse per hi-fi, computer e professionali. Struttura in acciaio tubolare, inclinabile all'indietro grazie al sistema di regolazione "EASY LOCK". Disponibile in nero opaco.
- *Nearfield monitor stand, ideal for a perfect acoustic positioning of hi-fi speakers, computers and professional speakers. Steel tube structure, tilts back thanks to the "EASY LOCK" locking system. It features a front arm and rubber footcaps. Available in matt black.*

EL680

- Supporto regolabile per monitor / amplificatore. Regolabile in altezza e dotato di sistema di blocco con pin di sicurezza. Disponibile in nero opaco.
- *Amplifier / monitor stand. With height-adjustment featuring a safety locking system by a security pin. Available in matt black.*

EL680

EL700

- Supporto per monitor regolabile in altezza con doppio braccio anteriore ripiegabile e piano posteriore inclinabile grazie al sistema di regolazione "EASY LOCK", per facilitare il posizionamento dell'apparecchio. Disponibile in grigio antracite.
- *Double front arm and tiltable rear shelf thanks to the "EASY LOCK" locking system. Supplied with an add-on adjustable shelf for an easy monitor positioning. Available in anthracite grey.*

TECH INFO

| Model: | EL620 | EL680 | EL700 |
|-------------------|--------------------|--------------------|------------------------------|
| Minimum height: | 100 mm (3.94") | 430 mm (16.92") | 200 mm (7.87") |
| Maximum height: | 250 mm (7.09") | 560 mm (2.04") | 500 mm (19.68") |
| Width: | 250 mm (9.84") | 490 mm (19.29") | 400 mm (15.74") |
| Arm dimension: | 250 mm (9.84") | 185 mm (7.28") | 140 x 330 mm (5.51 x 12.99") |
| Weight: | 2.10 kg (4.63 lbs) | 3.02 kg (7.05 lbs) | 5.30 kg (11.68 lbs) |
| Maximum load: | 40 kg (88.18 lbs) | 40 kg (88.18 lbs) | 45 kg (99.20 lbs) |
| Available colors: | Black | Black | Anthracite grey |
| Master Carton: | 1 pc. | 1 pc. | 1 pc. |

MONITOR STANDS "KP" SERIES

METAL SYSTEM



KP810D



KP845



KP840

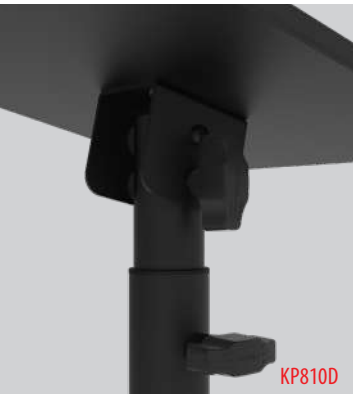

KP810D



KP810D



KP845

KP810D NEW

• Robusto supporto per monitor da tavolo che fornisce un sostegno molto stabile. L'altezza e l'inclinazione regolabili del ripiano, permettono un accurato collocamento del diffusore. Il ripiano superiore è fornito di pratiche fasce di foam per la protezione del cabinet e per un fermo posizionamento. Fornito con due differenti sistemi di fissaggio, con base piatta di appoggio e con morsetto a vite. Disponibile nel colore nero opaco.

• *Sturdy desktop monitor stand that provides very stable support. The adjustable height and inclination of the shelf allow accurate positioning of the speaker cabinet. The upper shelf is equipped with practical foam strips for the protection of the cabinet and for a firm positioning. Supplied with two different fixing systems, with flat support base and with screw clamp. Available in matt black color.*

KP840

• Supporto per monitor "near-field" a base triangolare. Equipaggiato con piedini conici per un isolamento ottimale dal terreno. La struttura tubolare in acciaio è provvista di un pratico sistema di regolazione dell'altezza da 850 a 1170 mm con pin di sicurezza (cinque differenti posizioni). Dimensioni del piatto: 230 x 230 mm. Perfetto per l'"home recording" e gli studi di registrazione. Disponibile in nero opaco.

• *Triangular base nearfield monitor stand. Provided with conical spikes to allow ground feedback insulation. Steel tube structure, provides a height adjustable pin security system from 850 mm to 1170 mm (five different positions). 230 mm x 230 mm upper plate size. Perfect for home recording and studio recording use. Available in matt black.*

KP845

• Supporto per monitor "near-field" dalle stesse caratteristiche del KP840, ma con sistema del blocco di sicurezza automatico. Disponibile in nero opaco.

• *Triangular base nearfield monitor stand, featuring same characteristics of KP840, but with automatic safety pin system. Available in matt black.*

TECH INFO

| Model: | KP810D | KP840 | KP845 |
|-------------------|-----------------------------|-----------------------------|-----------------------------|
| Minimum height: | 295 mm (11.61") | 850 mm (33.46") | 850 mm (33.46") |
| Maximum height: | 470 mm (18.50") | 1170 mm (46.06") | 1170 mm (46.06") |
| Base dimension: | 250 x 250 mm (9.84") | 450 mm x 3 (17.72") | 450 mm x 3 (17.72") |
| Plate dimension: | 230 x 230 mm (9.05 x 9.05") | 230 x 230 mm (9.05 x 9.05") | 230 x 230 mm (9.05 x 9.05") |
| Weight: | 1.75 kg (3.86 lbs) | 5.00 kg (11.02 lbs) | 5.00 kg (11.02 lbs) |
| Maximum load: | 12 kg (26.45 lbs) | 50 kg (110.23 lbs) | 50 kg (110.23 lbs) |
| Available colors: | Black | Black | Black |
| Master Carton: | 4 pcs. | 4 pcs. | 6 pcs. |

MONITOR & LAPTOP STANDS "KP" SERIES

METAL SYSTEM

KP820



KP820

KP875



KP875

KP820

- Supporto per monitor "near-field" estremamente stabile e regolabile in altezza da 83 a 132 cm. Dimensioni del piatto: 470 x 220 mm. Disponibile in nero opaco.
- *Nearfield tubular steel monitor stand, extremely stable, height-adjustment from 83 to 132 cm. Available in matt black.*

KP875

- Supporto professionale per laptop e proiettore ad altezza regolabile con base tripode. Piano superiore ad inclinazione variabile - dimensione 390 x 290 mm. Disponibile in nero opaco.
- *Professional height adjustable laptop/projector stand with tripod base. Variable angle upper plate - size 390 x 290 mm. Available in matte black.*

TECH INFO

| Model: | KP820 | KP875 |
|-------------------|-------------------------------|-------------------------------|
| Minimum height: | 830 mm (32.68") | 920 mm (36.22") |
| Maximum height: | 1320 mm (51.97") | 1400 mm (55.11") |
| Base dimension: | 380 x 400 mm (14.96 x 15.75") | 880 mm (34.64") |
| Plate dimension: | 470 x 220 mm (18.50 x 8.66") | 390 x 290 mm (15.35 x 11.41") |
| Weight: | 3.10 kg (6.83 lbs) | 4.92 kg (10.84 lbs) |
| Maximum load: | 60 kg (132.28 lbs) | 35 kg (77.16") |
| Available colors: | Black | Black |
| Master Carton: | 2 pcs. | 4 pcs. |

KP875



PROJECTOR MOUNTS "PRPH" SERIES

METAL SYSTEM

• Robusto supporto per videoproiettore realizzato in acciaio per montaggio a soffitto. Offre un posizionamento flessibile grazie ai quattro bracci di supporto regolabili che possono adattarsi ad una vasta gamma di proiettori grazie alla piastra di aggancio che può coprire una superficie da 225 a 316 mm di diametro. Regolazione dell'inclinazione di - 15° / + 15° e dello snodo - 8° / + 8°. Il connettore a sgancio rapido consente al proiettore di essere installato / disinstallato rapidamente e facilmente per le operazioni di manutenzione, senza necessità di effettuare il riallineamento. Può essere utilizzato per proiettori con un peso massimo fino a 20 kg. Colore argento. Disponibile in due diverse varianti: PRPH40S e PRPH50L.

• Heavy duty solid steel ceiling projector mount. It offers flexible projector positioning with four adjustable support arms that can fit a wide range of projectors thanks to the mounting plate that can cover a surface area from 225 up to 316 mm diameter. Tilting adjustment from - 15° up to + 15°, swivel setting from - 8° up to + 8°. The quick release connector allows the projector to be installed quickly and then easily released for maintenance, without re-alignment. It can be used for projectors weighing up to 20 kg. Silver color. Available in two different versions: PRPH40S e PRPH50L.

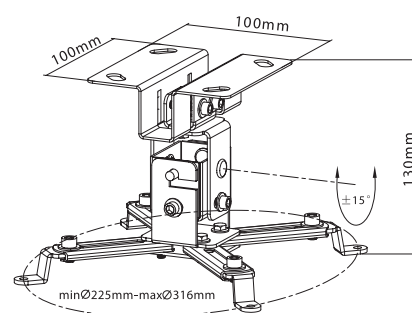
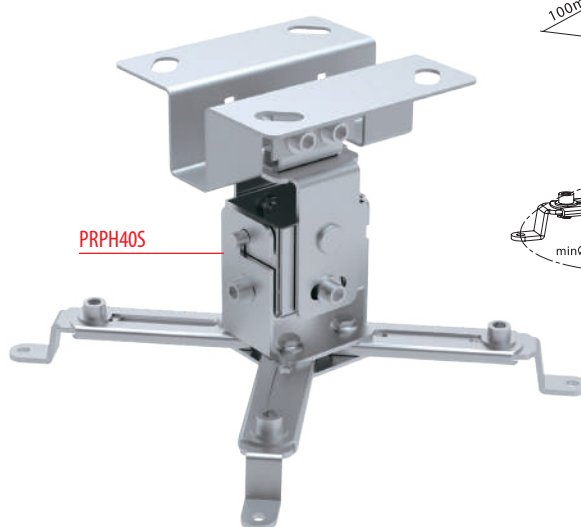
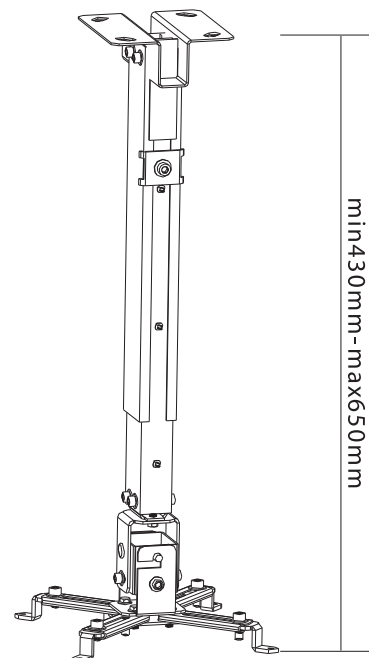
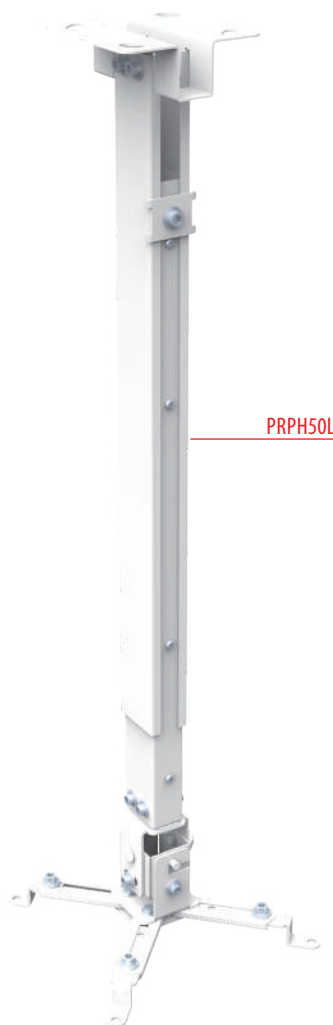

PRPH40S

- Robusto supporto per videoproiettore da soffitto con altezza fissa di 130 mm.
- Heavy duty ceiling projector mount. Fixed height of 130 mm.

PRPH50L

- Supporto per videoproiettore da soffitto con altezza regolabile da 430 mm fino ad un massimo di 650 mm. Dotato di sistema integrato per l'organizzazione dei cavi.
- Heavy duty ceiling projector mount with adjustable height range from 430 up to 650 mm. Featuring integrated cable management system.

BENCHES AND STOOL "EASY LOCK & KGST" SERIES METAL SYSTEM



EL30

- Panchetta ad altezza regolabile a tre posizioni realizzata in acciaio tubolare verniciato. Cuscino imbottito in poliuretano espanso ad alta densità e copertura in PVC nero. Disponibile in nero opaco.
- 3 positions height adjustable keyboard bench made of painted tubular steel. High density foam padded and black PVC covered cushion. Available in matt black.

EL50

- Panchetta professionale per tastiera, con sistema di regolazione "EASY LOCK", cuscino con spessa imbottitura in poliuretano espanso e copertura in vinile nero. Disponibile in grigio antracite.
- Professional keyboard bench, adjustable with "EASY LOCK" locking system, thick padded seat cushion, foam rubber filled, covered with black textured vinyl. Available in anthracite grey.

EL55

- Panca professionale regolabile per tastiera con struttura ad "X" in acciaio verniciato. Munita di cuscino di 80 mm di altezza imbottito con poliuretano espanso ad alta densità rivestito in vinile nero. Nuovo sistema di regolazione con guide e perni a molla. Disponibile in grigio antracite.
- Professional "X style" keyboard bench, painted steel construction. 80 mm height, high density foam padded and black vinyl cushion. Height adjustable with automatic steel guides and pivots new system. Available in anthracite grey.

KGST10

- Sgabello dal design innovativo, ideale per tutti i professionisti che desiderano suonare nel modo più confortevole, in particolare tastieristi e chitarristi. Realizzato in acciaio tubolare resistente, sedile inclinabile in poliuretano espanso ad alta densità, rinforzo in metallo e poggiatesta regolabile con coperture in gomma antiscivolo. Ripiegato può essere agevolmente riposto e trasportato. Disponibile in nero opaco.
- Innovative design stool, ideal for all professional musicians willing to play in the most comfortable way, especially for keyboard and guitar players. It features a heavy duty tubular steel structure, padded tiltable rubber seat, metal plate reinforcement and height - adjustable footrest with anti-slip grips. Folds down for easy storage and carriage. Available in matt black.

TECH INFO

| Model: | EL30 | EL50 | EL55 | KGST10 |
|-------------------|--------------------------------|--------------------------------|--------------------------------|---------------------|
| Base dimensions: | 450 mm (17.72") | 540 mm (21.26") | 600 mm (23.62") | 400 mm (15.75") |
| Minimum height: | 490 mm (19.30") | 490 mm (19.30") | 530 mm (20.87") | 600 mm (23.62") |
| Maximum height: | 560 mm (22.04") | 630 mm (24.80") | 630 mm (24.80") | 750 mm (29.52") |
| Seat size: | 400 x 300 mm (15.75" x 11.81") | 540 x 260 mm (21.20" x 10.24") | 600 x 310 mm (23.62" x 12.20") | Ø 450 mm (17.72") |
| Weight: | 3 Kg (6.61 lbs) | 4.90 kg (10.90 lbs) | 5.80 kg (12.79 lbs) | 5.00 kg (11.02 lbs) |
| Maximum load: | 80 Kg (176.37 lbs) | 100 kg (220.46 lbs) | 100 kg (220.46 lbs) | 100 kg (220.46 lbs) |
| Available colors: | Matt black | Anthracite grey | Anthracite grey | Black |
| Master Carton: | 5 pcs. | 5 pcs. | 5 pcs. | 1 pc. |



DRUMMER'S STOOL & THRONE "SGB" SERIES

METAL SYSTEM



SGB145



SGB155



SGB140



SGB85BK

SGB85BK

- Sgabello professionale multifunzione regolabile in altezza con snodo in metallo, imbottitura del sedile in poliuretano espanso ad alta densità e tre gambe ripiegabili con piedini in gomma per un posizionamento stabile sul pavimento. Disponibile in nero opaco.
- Professional multi-purpose stool, height-adjustment with metal swivel joint, hi-density seat padding, three foldable legs with rubber footcaps for a stable positioning on the floor. Matt black finish.

SGB140

- Sgabello professionale multifunzione con regolazione dell'altezza con sistema a vite e imbottitura del sedile in poliuretano espanso ad alta densità; tre gambe ripiegabili con piedini in gomma per un posizionamento stabile sul pavimento. Disponibile cromato.
- Professional multipurpose stool with screw height-adjustment and hi-density seat padding, three foldable legs with rubber footcaps for a stable positioning on the floor. Available in chrome only.

SGB145

- Sgabello professionale multifunzione con regolazione dell'altezza con sistema a vite e imbottitura del sedile in poliuretano espanso ad alta densità; tre gambe ripiegabili con piedini in gomma per un posizionamento stabile sul pavimento. Disponibile cromato.
- Professional multipurpose stool with screw height-adjustment and hi-density seat padding, three foldable legs with rubber foot caps for a stable positioning on the floor. Available in chrome only.



SGB85BK

SGB155

- Sgabello professionale per batteria con altezza regolabile; sedile rotondo con imbottitura ad alta densità e rivestimento in vinile nero. Struttura robusta con gambe a doppio braccio e piedini in gomma per un posizionamento stabile sul pavimento. Disponibile cromato.
- Professional drum throne, height adjustable round high density foam padded and black vinyl covered seat. Steady structure with double frame legs and rubber foot caps for a stable floor positioning. Available in chrome finish.

TECH INFO

| Model: | SGB85BK | SGB140 | SGB145 | SGB155 |
|-------------------|---------------------|---------------------|---------------------|----------------------------|
| Base dimensions: | Ø 540 mm (21.26") | Ø 450 mm (17.72") | Ø 560 mm (22.04") | Ø 590 mm (23.22") |
| Minimum height: | 480 mm (18.89") | 560 mm (22.05") | 470 mm (18.50") | 480 mm (18.89") |
| Maximum height: | 620 mm (24.40") | 780 mm (30.71") | 590 mm (23.22") | 615 mm (24.21") |
| Seat size: | Ø 320 mm (12.60") | Ø 300 mm (10.24") | Ø 280 mm (11.02") | 420*370 mm (16.53"*14.56") |
| Weight: | 3.60 kg (6.83 lbs) | 4.00 kg (8.82 lbs) | 3.14 kg (6.92 lbs) | 5.30 kg (11.68 lbs) |
| Maximum load: | 120 kg (264.55 lbs) | 112 kg (246.92 lbs) | 112 kg (246.92 lbs) | 120 kg (264.55 lbs) |
| Available colors: | Black | Chrome | Chrome | Chrome |
| Master Carton: | 4 pcs. | 5 pcs. | 5 pcs. | 4 pcs. |

DJ ACCESSORIES - LAPTOP STAND "LTS" SERIES

METAL SYSTEM



LTS001



LTS007C



LTS004PRO



LTS001

- Supporto PROEL per laptop, adatto per un'ampia gamma di sistemi DJ. Realizzato in acciaio verniciato nero, offre la regolazione in altezza e larghezza. Le staffe di supporto superiori sono ricoperte con foam adesivo per proteggere la superficie di appoggio dell'apparato in uso e per conferire maggiore presa/stabilità. Provvisto di nr. 2 clamps per il montaggio su flight case o tavolo ed include anche delle staffe per l'utilizzo in appoggio. Dimensioni: L 235/335mm x H 235/320mm x P 255mm.
- PROEL laptop stand, suitable for a wide range of DJ systems. Made of painted black steel, the LTS001 feature adjustable height and width. The support brackets above are covered with adhesive foam to protect the surface characteristics of the equipment in use as well as to provide better grip and stability. Equipped with 2 x clamps for easy and secure mounting on either a flight case or table and also includes support brackets. Dimensions: W 235/335mm x H 235/320mm x D 255mm.

LTS004PRO

- Nuovo supporto professionale pieghevole per laptop realizzato in alluminio pressofuso ad altezza fissa (300 mm). Dotato di ripiano aggiuntivo per il posizionamento di effetti, con regolazione a differenti posizioni. Fornito con pratica borsa di trasporto in nylon. Dimensioni: base L 250 mm x D 210 mm / piano intermedio L 125 mm x D 175 mm / piano superiore L 200 mm x D 200 mm. Dimensioni chiuso: 300 mm x 265 mm x 20 mm. Peso 1. 22 kg. Colore nero.
- New professional foldable laptop stand made of die-cast aluminum with fixed height (300 mm). Includes extra shelf for effects positioning, with adjustment to three different positions. Comes with practical nylon carrying bag. Dimensions: base W 250 mm x D 210 mm / intermediate level W 125 mm x D 175 mm / upper level W 200 mm x D 200 mm. Size when closed: 300 mm x 265 mm x 20 mm. Weight 1. 22 kg. Black color with chrome parts.



LTS007C

- Il nuovo supporto professionale regolabile per controller è particolarmente indicato per l'utilizzo in studio, per installazioni presso club ed anche per l'utilizzo domestico, per un'ottimale configurazione delle postazioni DJ, salvaguardando lo spazio da utilizzare. Dotato di supporto aggiuntivo per laptop. Colore nero opaco.
- New professional adjustable controller stand is particularly suitable for studio, club installations, as well as home use, for optimal configuration of the DJ booths, safeguarding the space to be used. Offering additional support for laptops. Matt black color.

MUSIC STANDS "RSM" SERIES

METAL SYSTEM

RSM295



RSM300



RSM295



RSM295

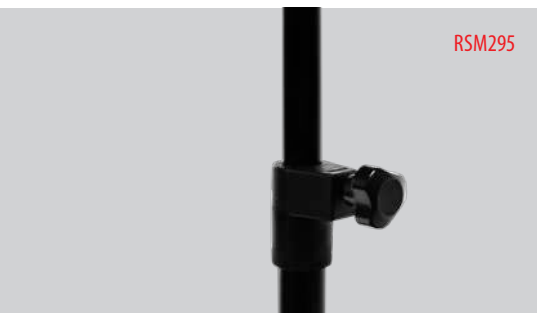

RSM295



RSM295
BAG Included

DIE CAST



RSM300
BAG Included

DIE CAST



RSM295 NEW

- Leggio con altezza regolabile a 3 sezioni con appoggia spartiti inclinabile, struttura in acciaio e parti di scorrimento in nylon. Pieghevole, più essere agevolmente riposto e trasportato con la pratica borsa di trasporto inclusa. Disponibile in finitura nero opaco.
- Music stand with 3-section adjustable height with tilting sheet music rest, steel structure and nylon sliding parts. Foldable, it can be easily stored and transported with the practical carrying bag included. Available in matt black finish.

RSM300

- Leggio da orchestra con altezza regolabile a 3 sezioni con appoggia spartiti inclinabile e struttura in acciaio. Pieghevole, più essere agevolmente riposto e trasportato. Disponibile in finitura nero opaco con pratica borsa di trasporto in nylon inclusa.
- Orchestra music stand, 3-section height-adjustable with tiltable music holder, heavy cast steel structure. Foldable, it can be easily stored and carried. Available in matt black finish with Nylon carrying bag included.

TECH INFO

| Model: | RSM295 | RSM300 |
|-------------------------|--|-------------------------------|
| Minimum height: | 470 mm (18.50") | 450 mm (17.71") |
| Maximum height: | 1160 mm (45.67") | 1060 mm (41.73") |
| Music sheet dimensions: | 415 (495) x 230 mm (16.34 (19.49) x 9.05") | 400 x 290 mm (14.75 x 11.42") |
| Weight: | 1.20 kg (2.64 lbs) | 1.40 kg (3.09 lbs) |
| Maximum load: | 2 kg (4.41 lbs) | 2 kg (4.41 lbs) |
| Available colors: | Black | Black |
| Master Carton: | 10 pcs. | 10 pcs. |

MUSIC STANDS "RSM" SERIES

METAL SYSTEM



RSM650



RSM700
BAG Included

DIE CAST



RSM650
BAG Included

DIE CAST

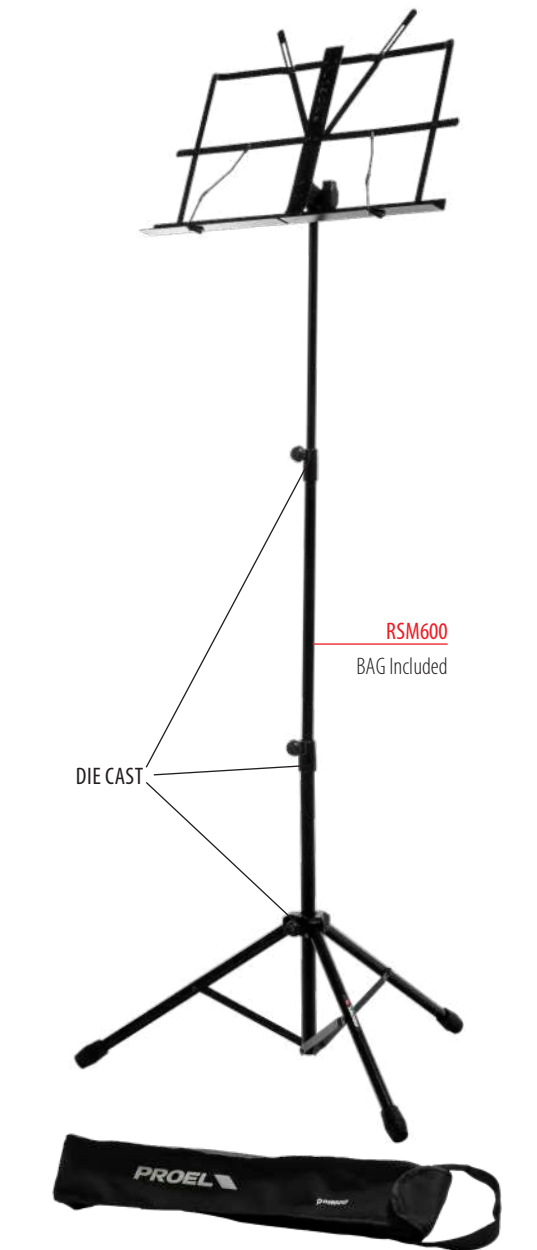

RSM600
BAG Included

DIE CAST

RSM600

- Leggio professionale in acciaio tubolare. Altezza regolabile a 3 sezioni, inclinabile grazie ai nuovi morsetti bloccanti, perfezionati per garantire la massima stabilità. Fornito di poggia spartiti orientabile, estremità antigraffio e piedini in gomma. Disponibile in finitura nero opaco con pratica borsa di trasporto in nylon inclusa.
- Professional sturdy steel tube music stand. Fully 3-section heightadjustable, tiltable by means of the new locking clamps, enhanced to grant maximum stability. Supplied with an orientable music holder, scratch-proof contact points and rubber footcaps. Available in matt black finish with Nylon carrying bag included.

RSM650

- Leggio professionale in acciaio tubolare. Altezza regolabile. Fornito di poggia spartiti in metallo forato, estremità antigraffio e piedini in gomma. Disponibile in finitura nero opaco con pratica borsa di trasporto in nylon inclusa.
- Professional sturdy steel tube music stand. Adjustable height. Supplied with a tiltable perforated metal sheet music holder, scratch-proof contact points and rubber footcaps. Available in matt black finish with practical nylon carrying bag included.

RSM700 NEW

- Leggio professionale in acciaio tubolare a 3 sezioni, ad altezza regolabile. Fornito di poggia spartiti in metallo forato, estremità antigraffio e piedini in gomma. Disponibile in finitura nero opaco con pratica borsa di trasporto in nylon inclusa.
- Professional sturdy steel tube 3-section music stand. Adjustable height. Supplied with a tiltable perforated metal sheet music holder, scratch-proof contact points and rubber footcaps. Available in matt black finish with practical nylon carrying bag included.



RSM650

TECH INFO

| Model: | RSM600 | RSM650 | RSM700 |
|-------------------------|-------------------------------|--|-------------------------------|
| Minimum height: | 500 mm (19.30") | 800 mm (31.49") - upper edge | 500 mm (19.30") |
| Maximum height: | 1120 mm (25.18") | 1400 mm (55.12") - upper edge | 1120 mm (25.18") |
| Music sheet dimensions: | 500 x 290 mm (19.69 x 11.42") | 412/400 x 250 mm (16.22/15.75 x 9.84") | 475 x 340 mm (18.70 x 13.38") |
| Weight: | 1.90 kg (4.19 lbs) | 1.790 kg (3.95 lbs) | 1.90 kg (4.19 lbs) |
| Maximum load: | 4 kg (8.82 lbs) | 5 kg (11.02 lbs) | 5 kg (11.02 lbs) |
| Available colors: | Black | Black | Black |
| Master Carton: | 10 pcs. | 10 pcs. | 10 pcs. |

MUSIC STANDS "RSM" SERIES

METAL SYSTEM



RSM365M
BAG Included



RSM360M
BAG Included



RSM360WOB
bag not Included

RSM360WOB - RSM360M

• Leggio professionale con appoggia spartiti perforato orientabile progettato per sostenere carichi notevoli. Nuovo sistema di bloccaggio antiscivolo per garantire una regolazione veloce dell'altezza e ampia base tripode. Disponibile in due modelli: struttura in acciaio con finitura in nero opaco e borsa in nylon (RSM360M) e struttura in acciaio con finitura in nero opaco senza borsa in nylon (RSM360WOB).

• Professional music stand with perforated orientable music holder designed to support the heaviest loads. New block clamp system for a fast, non slip height-adjustment, and a wide tripod base. Available in two Model:s: matt black polished steel structure with nylon bag (RSM360M), matt black polished steel structure without nylon bag (RSM360WOB).

RSM365M

• Leggio professionale con le stesse caratteristiche dell' RSM360M ma con superficie non forata. Disponibile in nero opaco.
• Professional music stand with the same features as the RSM360M but music holder is not perforated. Available in matt black.

TECH INFO

| Model: | RSM360M/RSM360WOB | RSM365M |
|-------------------------|-------------------------------|-------------------------------|
| Minimum height: | 980 mm (38.58") | 980 mm (38.58") |
| Maximum height: | 1350 mm (53.15") | 1350 mm (53.15") |
| Music sheet dimensions: | 485 x 350 mm (19.09 x 13.78") | 485 x 350 mm (19.09 x 13.78") |
| Weight: | 3.10 kg (6.83 lbs) | 3.20 kg (7.05 lbs) |
| Maximum load: | 6 kg (13.23 lbs) | 6 kg (13.23 lbs) |
| Available colors: | Black | Black |
| Master Carton: | 4 pcs. / 5 pcs. | 4 pcs. |



MUSIC STAND LIGHTS METAL SYSTEM



NEW MSLL06

- Lampada a LED per leggio con doppio flessibile in metallo ciascuno con diffusore a tre LED ad alta efficienza. Morsetto universale imbottito per un semplice e versatile utilizzo con pannelli di spessore fino ad un massimo di 25mm. Fornito di serie con 3 batterie AAA da 1,5V. Dotato di presa USB mini B per l'utilizzo diretto con cavo dedicato (non incluso). Disponibile in nero opaco.
- LED music stand light with two flexible metal goosenecks, each with three high energy-efficient LEDs. Equipped with a padded clamp for a simple and versatile coupling with max 25mm surface. 3*AAA 1,5 battery included in the package. Equipped with USB mini B socket for direct use with dedicated cable (not included). Available in matt black.



MSLL18 **NEW**

• La lampada LED professionale MSLL18 è il modello più importante della serie ed è dotata di 18 + 18 potenti LED per un'elevata luminosità. Ha due diverse impostazioni di temperatura - 3000 / 3500K e 6000 / 6500K - selezionabili con un interruttore posto sulla base. L'intensità per ogni temperatura è anche regolabile a due diversi livelli attraverso l'interruttore a sfioramento. Realizzata con un design raffinato, incorpora una robusta clip per essere utilizzata direttamente su un leggio o autoportante su una superficie piana. La parabola con i led può dirigere perfettamente la luce ed è ideale per illuminare grandi spartiti musicali e per molti altri usi. Sono incluse tre batterie AA e un cavo di alimentazione. La lampada può essere alimentata tramite USB o collegamento a una presa elettrica con l'alimentatore incluso. Disponibile in nero opaco.

• The MSLL18 professional LED lamp is the most important model in the series and is equipped with 18 + 18 powerful LEDs for high brilliance. It has two different temperature settings - 3000/3500K and 6000/6500K - which are selectable with a switch on the base. The intensity for each temperature is also adjustable with two different output levels by the touch switch. Produced with a refined design, it incorporates a sturdy recessed clip to be used directly over a music stand or self-supporting on a flat surface. The light housing can be used to direct the light perfectly onto a target and is ideal for illuminating large sheet music books as well as having many other uses. Three AA sized batteries and a power cord are included. The lamp can be powered via USB or connection to an electrical outlet with the power supply that is included. Available in matt black.

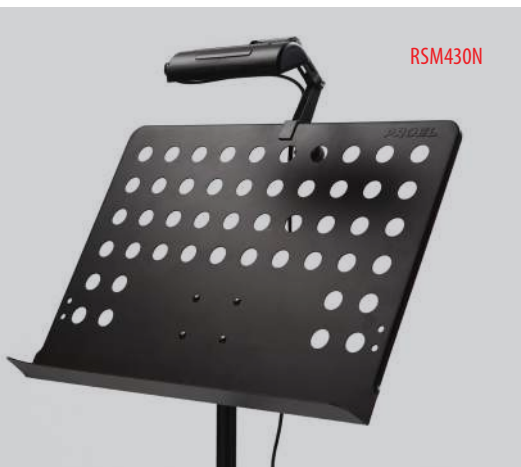

RSM430N

- Portalampana singolo realizzato in acciaio stampato, facilmente applicabile a qualsiasi leggio per mezzo del pratico morsetto regolabile. Fornito con cavo da 2 metri dotato di interruttore e spina europea. Attacco lampada E14-MAX 25 W. Finitura nero opaco.
- Single lamp holder, easily attachable to any music sheet stand by means of an adjustable clamp device. Supplied with 2 mt cable and plug. E14-25 W MAX suitable lamp. Matt black finish.

GOOSENECK LED LIGHTS "SDC" SERIES

METAL SYSTEM



SDC660PRO

- Lampada flessibile di alta qualità a LED lunga 330 mm con 4 LED di colore bianco e connettore XLR maschio 3 poli. Disponibile in nero opaco.
- Professional high quality LED gooseneck lamp, 330 mm length, with 4 white LEDs and 3P XLR male straight connection. Available in black.

SDC665PRO

- Lampada flessibile di alta qualità a LED lunga 330 mm con 4 LED di colore bianco e connettore XLR maschio 4 poli. Disponibile in nero opaco.
- Professional high quality LED gooseneck lamp, 330 mm length, with 4 white LEDs and 4P XLR male straight connection. Available in black.

SDC670PRO

- Lampada flessibile di alta qualità a LED lunga 330 mm con 4 LED di colore bianco e connettore BNC. Disponibile in nero opaco.
- Professional high quality LED gooseneck lamp, 330 mm length, with 4 white LEDs and BNC straight connection. Available in black.

SDC665RAPRO

- Lampada flessibile di alta qualità a LED lunga 450 mm con 4 LED di colore bianco con connettore maschio XLR 4poli ad angolo 90°. Disponibile in nero opaco.
- Professional high quality LED gooseneck lamp, 450 mm length, with 4 white LEDs and 4P XLR male right angle connection. Available in black.

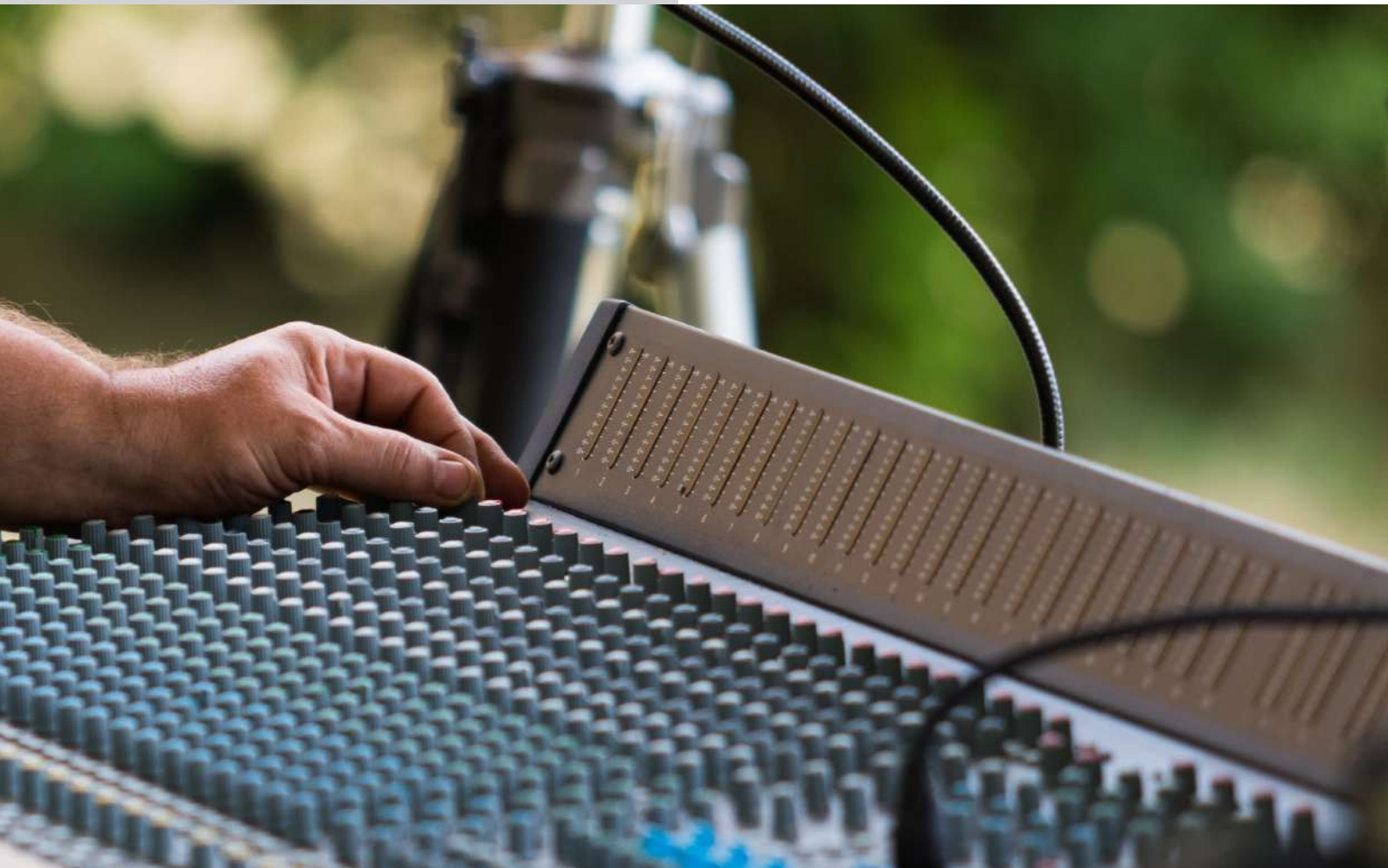

SPEAKER STANDS "SPSK" SERIES

METAL SYSTEM

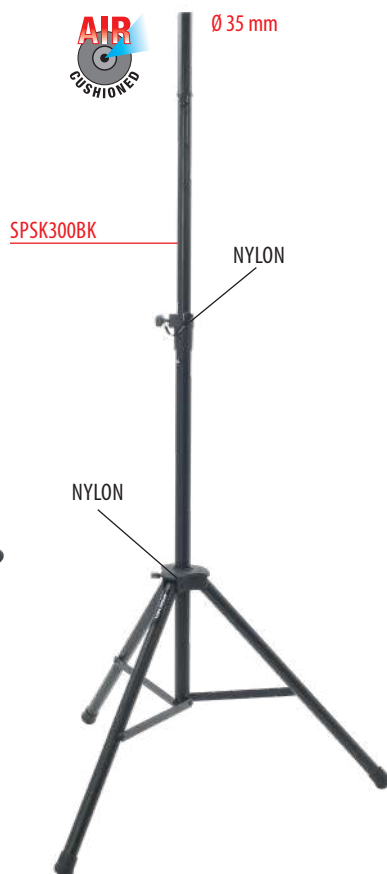
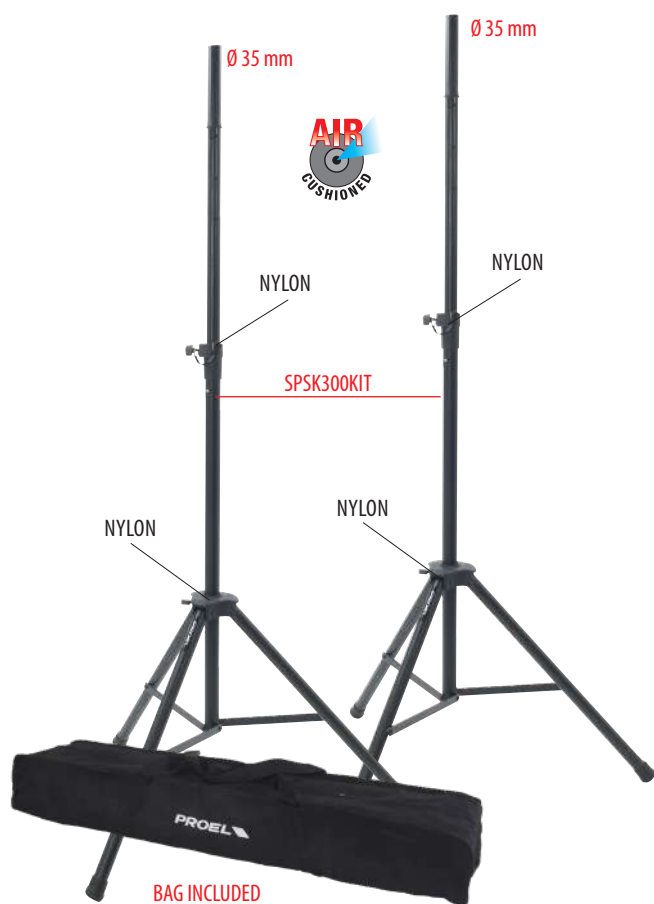

SPSK300AL - SPSK300BK

- Supporto professionale in alluminio per casse acustiche, dotato di sistema di bloccaggio a vite, pin di sicurezza in acciaio e dispositivo ad aria "Air-Cushioned" per garantire massima flessibilità, velocità e facilità nelle operazioni di regolazione. Disponibile in alluminio verniciato nero (SPSK300BK) e in alluminio verniciato color argento (SPSK300AL).
- Professional aluminium speaker stand supplied with a screw locking system, a steel security pin and "Air-cushioned" air-damped release device to grant a flexible, fast and easy adjustment. Available in black anodized aluminium (SPSK300BK) and in silver anodized aluminium (SPSK300AL) finish.

SPSK300KIT

- Coppia di supporti in alluminio per casse acustiche SPSK300BK forniti in pratica borsa di trasporto in Nylon 210D. Confezione da 1 set.
- Pair of SPSK300BK aluminium speaker stands, provided with a practical nylon 210D carrying bag. Master pack of 1 set.

TECH INFO

| | |
|--------------------------|---|
| Model: | SPSK300AL/SPSK300BK |
| Base dimension: | 1120 mm (44.09") |
| Minimum height: | 1460 mm (57.48") |
| Maximum height: | 2060 mm (81.10") |
| Weight: | 2.80 kg (27.46 lbs) |
| Maximum load: | 60 kg (132.207 lbs) |
| Available colors: | Silver (SPSK300AL) Black (SPSK300BK) |
| Master Carton: | 2 pcs. |

SPEAKER STANDS "SPSK" SERIES

METAL SYSTEM



SPSK290BK

- Mini supporto in alluminio per casse acustiche di piccole dimensioni, munito di sistema di bloccaggio a vite, pin di sicurezza in acciaio e dispositivo ad aria "Air-Cushioned". Disponibile in alluminio verniciato nero (SPSK290BK).
- Mini aluminium stand for small speakers, supplied with screw locking system, steel security pin and "Air-cushioned" air-damped device. Available in black anodized aluminium (SPSK290BK) finish.

SPSK310BK

- Supporto professionale in alluminio per casse acustiche, munito di sistema di bloccaggio a vite, pin di sicurezza in acciaio e dispositivo ad aria "Air-Cushioned". Disponibile in alluminio verniciato nero (SPSK310BK).
- Professional aluminium speaker stand, supplied with screw locking system, steel security pin and "Air-cushioned" air-damped device. Available in black anodized aluminium (SPSK310BK) finish.

SPSK105BKF5

- Supporto in acciaio per molteplici applicazioni, con robusta base e manicotto superiore dotato di pin di sicurezza. Facile da maneggiare e trasportare. Diametro tubo superiore: 25mm. Provvisto di adattatore con vite M6. Disponibile finitura nero opaco.
- Multi-purpose steel speaker stand providing a safe base for multiple applications. Discrete look, easy to handle and carry. Upper end diameter: 25mm. Provided with M6 screw adapter. Available in matt black finish.

SPSK SERIES
CLUTCH SYSTEM
DETAIL



TECH INFO

| Model: | SPSK290BK | SPSK310BK | SPSK105BKF5 |
|-------------------|---------------------|---------------------|---------------------|
| Base dimension: | Ø 780 mm (30.71") | Ø 1480 mm (58.27") | Ø 880 mm (34.65") |
| Minimum height: | 1170 mm (46.06") | 1740 mm (68.50") | 1190 mm (46.85") |
| Maximum height: | 1670 mm (65.75") | 2640 mm (103.94") | 2000 mm (78.74") |
| Weight: | 2.15 kg (21.08 lbs) | 3.15 kg (30.89 lbs) | 1.65 kg (16.18 lbs) |
| Maximum load: | 30 kg (294.20 lbs) | 70 kg (686.47 lbs) | 30 kg (294.20 lbs) |
| Available colors: | Black | Black | Black |
| Master Carton: | 2 pcs. | 2 pcs. | 6 pcs. |

SPEAKER STANDS "FRE" SERIES

METAL SYSTEM

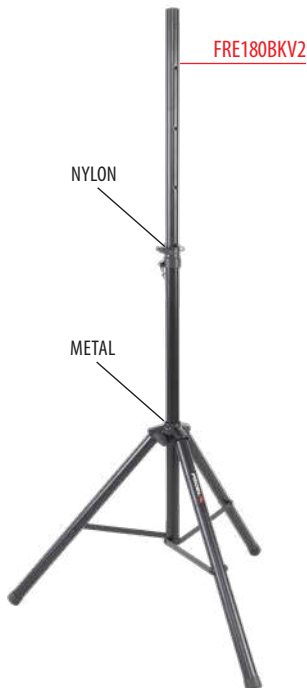
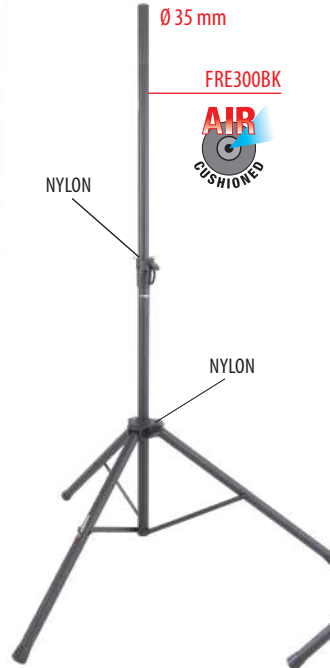

FRE180BKV2

NEW

- Supporto in acciaio per casse acustiche, regolabile in altezza e dotato di sistema di sicurezza con pin in acciaio. Snodo dei gambi in metallo. Disponibile in nero opaco.
- Height adjustable steel speaker stand, featuring steel security pin. Metal legs joint. Available in matt black.

FRE180KITV2

- Coppia di supporti in acciaio per casse acustiche FRE180BKV2 forniti in pratica borsa di trasporto in Nylon 210D. Confezione da 3 set.
- Pair of FRE180BKV2 steel speaker stands, provided with a practical nylon 210D carrying bag. Master pack of 3 sets.

FRE300BK

- Supporto in alluminio per casse acustiche, regolabile in altezza e dotato di sistema di sicurezza con pin in acciaio ed ora anche con dispositivo ad aria "Air-Cushioned". Disponibile in nero opaco.
- Height adjustable lightweight aluminium speaker stand, featuring steel security pin and now available with the well know "Air-Cushioned" system. Available in matt black.

FRE300KIT

- Coppia di supporti in alluminio per casse acustiche FRE300BK forniti in pratica borsa di trasporto in Nylon 210D. Confezione da 1 set.
- Pair of FRE300BK aluminium speaker stands, provided with a practical nylon 210D carrying bag. Master pack of 1 set.

TECH INFO

| Model: | FRE180BKV2 / FRE180KITV2 | FRE300BK / FRE300KIT |
|-------------------|---|---|
| Base dimension: | Ø 980 mm (38,58") | Ø 1320 mm (51,97") |
| Minimum height: | 1200 mm (47,24") | 1350 mm (53,15") |
| Maximum height: | 1800 mm (70,86") | 2150 mm (84,65") |
| Weight: | 2,9 Kg single (6,39 lbs) - 5,9 Kg set (13,01 lbs) | 2,10 kg single (4,62 lbs) - 4,80 kg (10,58 lbs) |
| Maximum load: | 40 Kg (88,18 lbs) | 50 kg (490,33 lbs) |
| Available colors: | Black | Black |
| Master Carton: | 4 pcs. / 3 sets | 6 pcs. / 1 set |

FRE180BKV2

SPEAKER STANDS ACCESSORIES

METAL SYSTEM



SPSK300BAG



PRSSBAG01



PRSSBAG02

SPSK300BAG

- Robusta borsa in Nylon 210D in grado di contenere n° 2 SPSK300 e supporti di misura simile. Zip in metallo e due manici laterali per un trasporto agevole. Disponibile in nero. Dimensioni interne: 1050 x 240 x 155 mm.
- Tough nylon 210 bag for two SPSK300 and stands of similar sizes. Metal zip and two side handles for easy transport. Available in black. Dimensions: 1050 x 240 x 155 mm.

PRSSBAG01 **NEW**

- Robusta borsa in Nylon 600D per supporto casse singolo. Zip in metallo e due manici laterali per un trasporto agevole. Disponibile in nero. Dimensioni interne: 1100 x 130 x 130 mm.
- Tough nylon 600D bag for single speaker stand. Metal zip and two side handles for easy transport. Available in black. Inner dimensions: 1100 x 130 x 130 mm.

PRSSBAG02 **NEW**

- Robusta borsa in Nylon 600D, imbottitura da 5 mm, per due supporti casse. Zip in metallo e due manici laterali per un trasporto agevole. Disponibile in nero. Dimensioni interne: 1100 x 260 x 155 mm.
- Tough padded nylon 600D bag for two speaker stands. Metal zip and two side handles for easy transport. Available in black. Inner dimensions: 1100 x 260 x 155 mm.



SSCOVBK - SSCOVWH **NEW**

- Copertura in tela per stativi a treppiede per diffusori acustici e apparati luce. Realizzata con un materiale elastico che permette di rivestire completamente lo stand su tutti i lati. Ideale per occasioni speciali come matrimoni, eventi, conferenze e anche per allestimenti DJ. Questa copertura in tela offre un aspetto pulito e professionale. Dotata di accessori che ne consentono un facile posizionamento su tutti i tipi di stativo, è inoltre fornita di pratica sacca di trasporto con chiusura a zip. Colori disponibili: nero (SSCOVBK) e bianco (SSCOVWH).
- Scrim cover for loudspeaker and lighting tripod stands. Made with an elastic material which allows you to completely cover the stand on all sides. Ideal for special occasions such as weddings, events, conferences and also for DJ set-ups. This scrim cover offers a clean and professional appearance. Equipped with accessories that allow for easy positioning on all types of stands, it also comes with a practical, zip fastening, bag for storage and transportation. Available colors: Black (SSCOVBK) and White (SSCOVWH).

SPEAKER STANDS & ACCESSORIES "KP" SERIES

METAL SYSTEM



KP210

- Supporto distanziatore cassa-subwoofer regolabile in acciaio con terminali Ø 35 mm. Dotato di meccanismo di chiusura a vite con pin in acciaio per la massima sicurezza. Regolazione: 825 - 1320 mm. Disponibile in nero opaco.
- Adjustable speaker pole for speaker-subwoofer separation with terminal pieces Ø 35 mm. Supplied with a bolt locking mechanism incorporating a steel pin for extra safety. Adjustment: 825 - 1320 mm. Available in matt black.

KP210S

- Supporto distanziatore cassa-subwoofer regolabile in acciaio con terminale inferiore avvitabile (provvisto di vite M20 x 2,5). Dotato di meccanismo di bloccaggio a vite con pin in acciaio per la massima sicurezza. Regolazione: 735 - 1230 mm. Disponibile in nero opaco.
- Adjustable speaker pole for speaker-subwoofer separation with screw-mount bottom terminal piece (supplied with screw M20 x 2.5). It features a bolt locking mechanism incorporating a steel pin for extra safety. Adjustment: 735 - 1230 mm. Available in matt black.

KP225

- Supporto regolabile - 310 - 490 mm (12.20 - 19.29") - per coppia di casse acustiche, realizzato in acciaio tubolare, installabile su qualsiasi stativo con tubo terminale Ø 35 mm. Disponibile in nero opaco.
- Extensible - 310 - 490 mm (12.20 - 19.29") - steel tube stand for speaker pair that can be mounted on any other PROEL speaker and lighting stand Ø 35 mm. Available in matt black.

KP305N

- Flangia in alluminio pressofuso con attacco per terminale Ø 35 mm. Altezza esterna 96 mm. Disponibile in nero opaco.
- Die cast aluminium flange for Ø 35 mm tube. Available in matt black.

WALL MOUNT SPEAKER STANDS "KP500" SERIES

METAL SYSTEM

Ø 35 mm

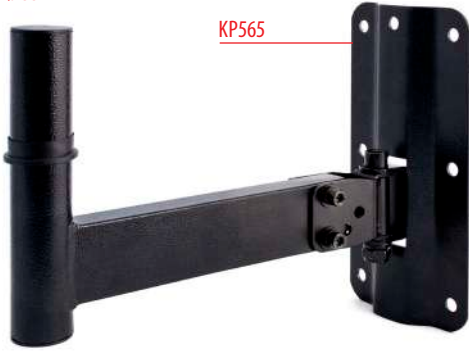

Ø 35 mm

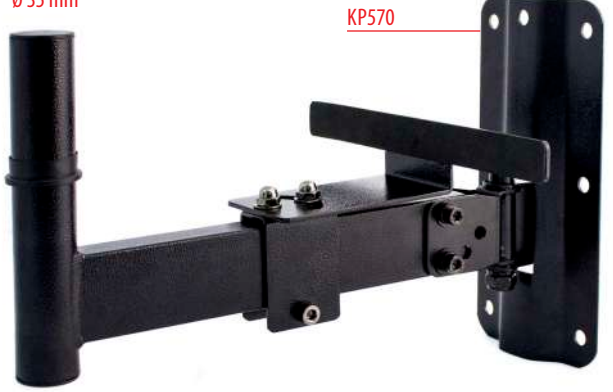

Ø 35 mm

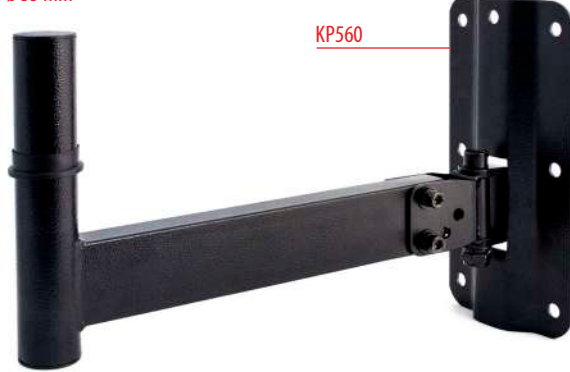

Ø 35 mm



Ø 35 mm



KP560 - KP560WH

- Robusto supporto in acciaio tubolare a parete per casse acustiche. Lo snodo direzionale permette una regolazione completa, sia verticale che orizzontale. Disponibile in nero opaco (KP560) e Bianco (KP560WH).
- Wall mount heavy duty steel tube speaker stand. The directional mounting bracket allows both horizontal and vertical adjustment. Available in matt black (KP560) and White (KP560WH).

KP565 - KP565WH

- Robusto supporto in acciaio tubolare a parete per casse acustiche di ridotte dimensioni (Profondità del tubolare 20 cm). Lo snodo direzionale permette una regolazione completa, sia verticale che orizzontale. Disponibile in nero opaco (KP565) e Bianco (KP565WH).
- Wall mount heavy duty steel tube speaker stand. The directional mounting bracket allows both horizontal and vertical adjustment. Available in matt black (KP565) and White (KP565WH).

KP570

- Robusto supporto in acciaio tubolare a parete per casse acustiche con staffa posteriore di sicurezza. Lo snodo direzionale permette una regolazione completa, sia verticale che orizzontale. Disponibile in nero opaco.
- Wall mount heavy duty steel tube speaker stand with safety rear brace. Directional mounting bracket allows both horizontal and vertical adjustment. Available in matt black.

Ø 35 mm



KP595

- Robusto supporto in acciaio tubolare a parete per casse acustiche con staffa posteriore di sicurezza. Lo snodo direzionale permette una regolazione completa, sia verticale che orizzontale ed inoltre è provvisto di regolazione frontale dell'inclinazione da 0° a 30°. Disponibile in nero opaco.
- Wall mount heavy duty steel tube speaker stand with safety rear brace. Directional mounting bracket allows both horizontal and vertical adjustment and it is also provided with frontal tilting adjustment from 0° to 30°. Available in matt black.

TECH INFO

| Model: | KP560/KP560WH/KP570 | KP565/KP565WH | KP595 |
|-------------------|--|----------------------------------|-----------------------------------|
| Width: | 124 mm (4.88") | 124 mm (4.88") | 123 mm (4.84") |
| Height: | 250 mm (9.84") | 250 mm (9.84") | 250 mm (9.84") |
| Depth: | 380 mm (14.96") | 280 mm (11.02") | 385 mm – 535 mm (15.16" – 21.06") |
| Weight: | 2.20 kg (4.85 lbs) KP560 2.90 kg (6.39 lbs) KP570 | 2.10 kg (4.63 lbs) | 3.50 kg (7.72 lbs) |
| Maximum load: | 35.00 kg (77.16 lbs) | 35.00 kg (77.16 lbs) | 35.00 kg (77.16 lbs) |
| Available colors: | Black (KP560/ KP570) White (KP560WH) | Black (KP565) White (KP565WH) | Black |
| Master Carton: | 6 pcs. (1 pc.) | 6 pcs. (1 pc.) | 4 pcs. |

FRONT TOWER LIFT "PLWIN" SERIES

METAL SYSTEM



certified by



DEKRA Certification
BGV C1



* NOTE

PLWIN650PRO

* TRUSS PIECE AND HOLDERS NOT INCLUDED

PLWIN650PRO

• Robusto elevatore frontale a torre, molto potente e versatile da usare, particolarmente adatto al sollevamento di sistemi line-array, strutture truss molto pesanti e schermi a LED. Prodotto semplice da trasportare, nonostante la mole, grazie alle ruote inserite nella base e di facile impiego anche su superfici irregolari. Il sistema di elevazione è quello tradizionale con v. ericello WCH e funi in acciaio. I piedi della base hanno ciascuno un'ampia regolazione indipendente che rende più agevole il posizionamento anche su superfici inclinate o irregolari. Prodotto con certificazioni [CE 89/392 EWG] [BGV C1, BGG 912].

• Rugged forklift tower, very powerful and versatile to use, especially suitable for lifting line-array systems, very heavy truss structures and LED screens. Product easy to carry, despite its size, thanks to the wheels inserted in the base and easy to use even on uneven surfaces. The elevator system is the traditional one with WCH winch and steel cables. It satisfy [CE 89/392 EWG] [BGV C1, BGG 912] certifications.

TECH INFO

| | |
|-------------------------|--|
| Model: | PLWIN650PRO |
| Maximum height: | 6500 mm (255,91") |
| Minimum height: | 1990 mm (78,35") |
| Base dimension: | 2490 mm x 2190 mm (98,03" x 86,22") |
| Folded position: | 1990 x 510 x 590 mm (78,35" x 20,08" x 23,23") |
| Weight: | 189 Kg (416,67 lbs) |
| Maximum load: | 350 Kg (771,62 lbs) |
| Available color: | Black |
| Master Carton: | 1 pc. |



FRONT TOWER LIFT "PLWIN" SERIES

METAL SYSTEM



certified by



DEKRA Certification
BGV C1



PLWIN540PRO



PLWIN540PRO

• Robusto elevatore frontale a torre, molto potente e versatile da usare, particolarmente adatto al sollevamento di sistemi line-array, strutture truss molto pesanti. Prodotto semplice da trasportare, nonostante la mole, grazie alle ruote inserite nella base e di facile impiego anche su superfici irregolari. Il sistema di elevazione è quello tradizionale con verricello WCH e funi in acciaio. I piedi della base hanno ciascuno un'ampia regolazione indipendente che rende più agevole il posizionamento anche su superfici inclinate o irregolari. Prodotto con certificazioni [CE 89/392 EWG] [BGV C1, BGG 912].

• Rugged forklift tower, very powerful and versatile to use, especially suitable for lifting line-array systems, very heavy truss structures. Product easy to carry, despite its size, thanks to the wheels inserted in the base and easy to use even on uneven surfaces. The elevator system is the traditional one with WCH winch and steel cables. It satisfy [CE 89/392 EWG] [BGV C1, BGG 912] certifications.

TECH INFO

| | |
|-------------------------|--|
| Model: | PLWIN540PRO |
| Maximum height: | 5400 mm (212,6") |
| Minimum height: | 1760 mm (69,29") |
| Base dimension: | 1620 mm x 1640 mm (63,68" x 63,57") |
| Folded position: | 1760 x 480 x 480 mm (69,29" x 18,90" x 18,90") |
| Weight: | 98 Kg (216,05 lbs) |
| Maximum load: | 250 Kg (551,16 lbs) |
| Available color: | Black |
| Master Carton: | 1 pc. |

LIGHTING STAND "PLWIN" SERIES

METAL SYSTEM



certified by



DEKRA Certification
BGV C1



PLWIN610



PLWIN610

• Robusto elevatore telescopico realizzato in acciaio; di facile trasporto e di rapido impiego anche su superfici irregolari. Il sistema di elevazione è quello tradizionale con verricello AL-KO e funi in acciaio. I piedi della base hanno ciascuno un'ampia regolazione indipendente che rende più agevole il posizionamento anche su superfici inclinate o irregolari. Prodotto con certificazioni [CE 89/392 EWG] [BGV C1, BGG 912].

• Heavy duty telescopic lift stand, made of steel; easy to transport and fast to set up, even on uneven surfaces. The lifting is ensured by a traditional system using AL-KO winch with steel rope. The base feet may be adjusted independently and extensively for easy positioning even on sloping and irregular surfaces. It satisfy [CE 89/392 EWG] [BGV C1, BGG 912] certifications.

TECH INFO

| | |
|-------------------------|--|
| Model: | PLWIN610 |
| Maximum height: | 6100 mm (240,16") |
| Minimum height: | 1920 mm (75,59") |
| Base dimension: | 2000 mm x 2000 mm (78,74" x 78,74") |
| Folded position: | 1920 x 470 x 470 mm (75,59" x 18,50" x 18,50") |
| Weight: | 90 kg (198,42 lbs) |
| Maximum load: | 300 kg (661,39 lbs) |
| Available color: | Black |
| Master Carton: | 1 pc. |

LIGHTING STAND "PLWIN" SERIES

METAL SYSTEM



certified by



DEKRA Certification
BGV C1



PLWIN530



PLWIN530

• Robusto elevatore telescopico realizzato in acciaio; di facile trasporto e di rapido impiego anche su superfici irregolari. Il sistema di elevazione è quello tradizionale con verricello AL-KO e funi in acciaio. I piedi della base hanno ciascuno un'ampia regolazione indipendente che rende più agevole il posizionamento anche su superfici inclinate o irregolari. Prodotto con certificazioni [CE 89/392 EWG] [BGV C1, BGG 912].

• Heavy duty telescopic lift stand, made of steel; easy to transport and fast to set up, even on uneven surfaces. The lifting is ensured by a traditional system using AL-KO winch with steel rope. The base feet may be adjusted independently and extensively for easy positioning even on sloping and irregular surfaces. It satisfy [CE 89/392 EWG] [BGV C1, BGG 912] certifications.

TECH INFO

| | |
|-------------------------|--|
| Model: | PLWIN530 |
| Maximum height: | 5300 mm (208,66") |
| Minimum height: | 1730 mm (68,11") |
| Base dimension: | 1900 mm x 1900 mm (74,80" x 74,80") |
| Folded position: | 1730 x 390 x 390 mm (68,11" x 15,35" x 15,35") |
| Weight: | 48 Kg (105,82 lbs) |
| Maximum load: | 150 Kg (330,69 lbs) |
| Available color: | Black |
| Master Carton: | 1 pc. |

LIGHTING STANDS "PLWIN" SERIES ACCESSORIES AND "PL" STAND METAL SYSTEM



PLH582



PLH583



PLH584

PLH585



PLH508



PLH565LF

PLH565LF

- Adattatore in acciaio da utilizzare in caso di posizionamento di elementi "truss" sulle forche degli elevatori frontali (PLWIN540PRO – PLWIN650PRO). Dotato di pin di sicurezza con anello di blocco. Confezione standard: 1 pezzo.
- Steel adapter for use in the event of placement of "truss" elements on the forks of the front lifts PLWIN540PRO – PLWIN650PRO. It is equipped with a safety pin with clamping ring. Master pack: 1 pc.

PLH582* - PLH584* - PLH583* - PLH585*

- Adattatori professionali realizzati in acciaio zincato per la sospensione di sistemi acustici utilizzabili soltanto con le torri PLWIN650PRO e PLWIN540PRO. PLH582 (per sistemi medio / grandi) – PLH584 per sistemi medio / piccoli) vengono utilizzati per sospendere e fornire l'angolazione ai sistemi, mentre PLH583 (per sistemi medio / grandi) - PLH585 per sistemi medio / piccoli) occorrono per fissare i sistemi nella posizione desiderata.
- *Questi adattatori vengono venduti in coppia (PLH582 + PLH583) – (PLH584 + PLH585).
- Professional adapters made of galvanized steel for the suspension of acoustic systems that can be used with the towers PLWIN650PRO and PLWIN540PRO. The PLH582 (medium / large systems) and PLH584 (medium / small systems) are used to fly the systems and provide the angle to them, while PLH583 (medium / large systems) and PLH585 (medium / small systems) are necessary to fix the systems in the desired position.
- *These adapters are sold together (PLH582 + PLH583) – (PLH584 + PLH585).

PLH508

- Staffa professionale in acciaio zincato, di larghezza 540 mm, dotata di due accoppiatori in alluminio regolabili in larghezza, per l'utilizzo con truss quadrate e triangolari. Interasse regolabile da mm 185 a mm 414. Confezione standard: 1 pezzo.
- Professional galvanized steel truss bracket – 540 mm (21.25") width, equipped with two adjustable aluminum couplers in width, for use with square and triangular truss. Wheelbase adjustable from 185 mm to 414 mm. Standard packaging: 1 piece.

PL8545

- Supporto professionale per sistemi luce in acciaio tubolare zincato. Provvisto di una gamba livellante controllata da un dispositivo ergonomico in alluminio pressofuso, con scanalature anticivolo (include un foro per cacciavite), per garantire la perfetta e costante verticalità del supporto in condizioni estreme. Dotato di un "argano a manovella" con freno automatico.
- Professional galvanized steel tube lighting stand. Supplied with a levelling leg controlled by an ergonomic die cast aluminium device, with anti skid slots (includes a hole for screwdriver) to grant a perfect and constant vertical stand in extreme conditions. It features a "winch" with automatic brake.

TECH INFO

| | |
|-------------------------|--------------------|
| Model: | PL8545 |
| Maximum height: | 4000 mm (157.48") |
| Minimum height: | 1870 mm (73.62") |
| Base dimension: | 1600 mm (62.99") |
| Folded position: | 1750 mm (68.90") |
| Weight: | 23 kg (50.70 lbs) |
| Maximum load: | 85 kg (187.39 lbs) |
| Available color: | Black |
| Master Carton: | 1 pc. |

PL8545



LIGHTING STANDS

METAL SYSTEM

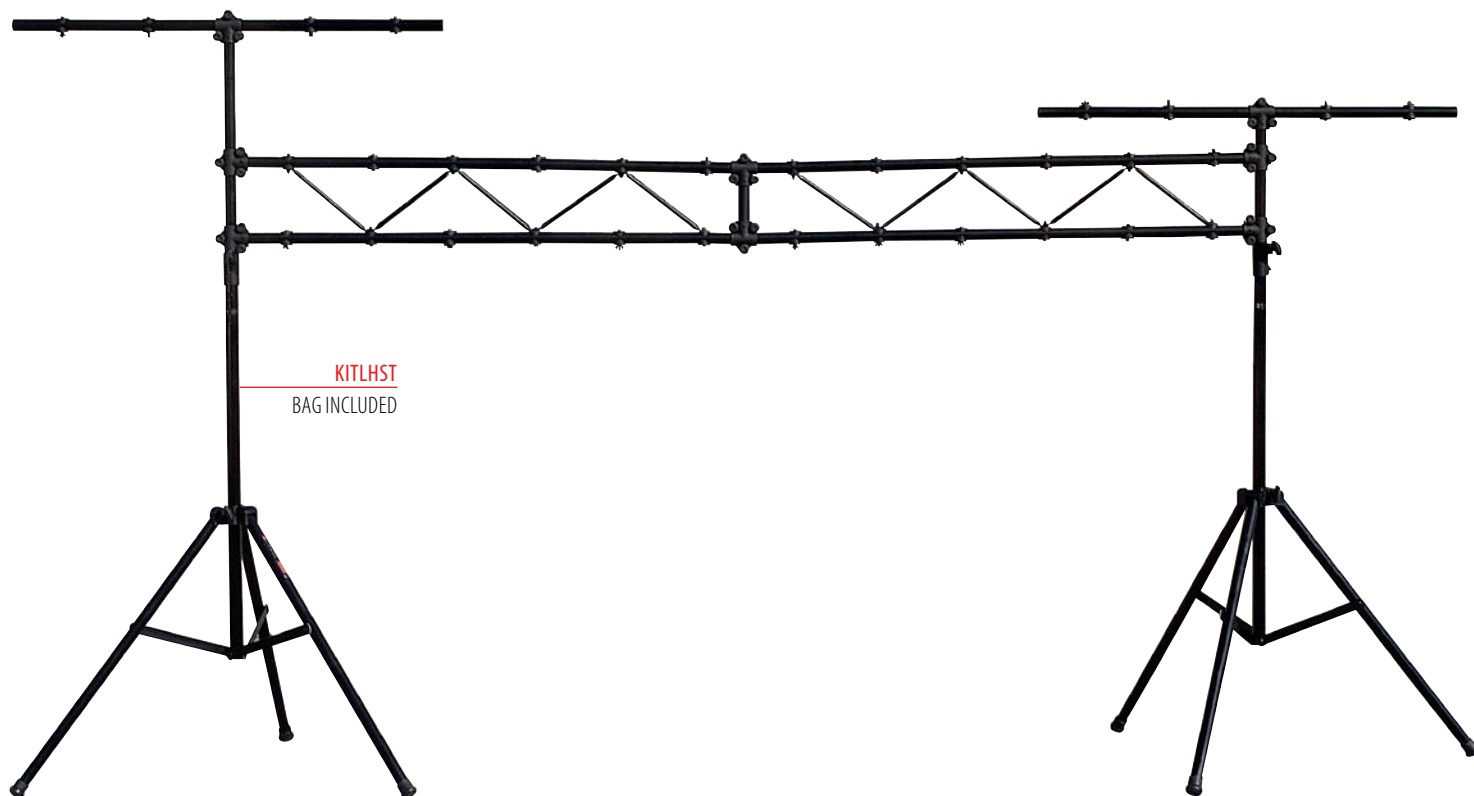

KITLHST
BAG INCLUDED

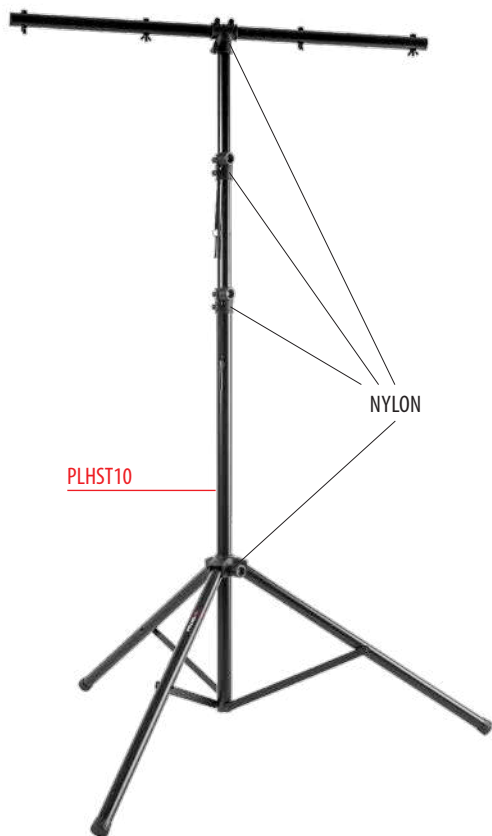

PLHST10

NYLON

KITLHST

- Struttura in alluminio anodizzato nero per luci, carico massimo 50 kg, completa di 2 supporti professionali regolabili, altezza massima 3,25 m, 2 barre orizzontali per 8 fari (1,25 m) e 2 truss in alluminio (lunghezza singola truss 1,5 m). Completa di resistente e pratica borsa di trasporto in Nylon.
- *Black anodized aluminium structure for lighting, max load 50 Kg, including 2 professional adjustable stands, max height 3,25 mt, 2 horizontal bars (1,25 mt) for 8 par cans, 2 aluminium trusses (truss single length: 1,5 mt) including a strong nylon carrying bag.*

PLHST10

- Nuovo supporto in alluminio per luci con barra "T" orizzontale inclusa, per poter posizionare fino ad un massimo n° 8 fari. Snodi della base e del sistema di regolazione in altezza realizzati in nylon caricato con fibra di vetro. Dotato di pin di sicurezza per il sistema di regolazione in altezza. Tubo terminale con Ø 35 mm. Disponibile nel colore nero opaco.
- *New aluminum lighting stand with an horizontal "T" bar included; suitable up to n° 8 headlights. Base and height adjusting system joints are made in nylon reinforced with glass fiber. Equipped with steel safety pin on the height adjusting system. Ø 35 mm terminal tube. Available in matt black.*

TECH INFO

| Model: | PLHST10 | KITLHST |
|-------------------|---------------------|---------------------|
| Minimum height: | 2100 mm (82.67") | 1470 mm (57.87") |
| Maximum height: | 3200 mm (125.98") | 3250 mm (127.95") |
| Base dimension: | Ø 1600 mm (62.99") | Ø 1400 mm (55.12") |
| Weight: | 4.70 kg (10.36 lbs) | 22.5 kg (49.60 lbs) |
| Maximum load: | 20 Kg (44.09 lbs) | 50 kg (110.20 lbs) |
| Available colors: | Black | Black |
| Master Carton: | 4 pcs. | 1 pc. |

LIGHTING STANDS ACCESSORIES

METAL SYSTEM



KP120



KP135



PLH420



PLKP182FL



PLSPN01

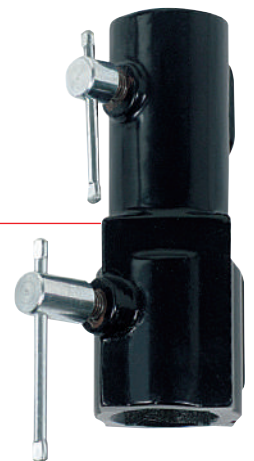

PLADT01

KP120

- Barra orizzontale telescopica a T in acciaio tubolare per sostenere fino a 8 fari, installabile su tutti i supporti PROEL per casse e/o luci con tubo terminale Ø 35 mm. Disponibile in nero opaco.
- Steel tube telescopic horizontal T-bar to support up to 8 par cans. It can be assembled on a lightning stand with Ø 35 mm connection. Available in matt black.

KP135

- Barra orizzontale in acciaio per 4 fari e/o effetti luce, da 70 cm con attacco a canotto Ø 35 mm. Disponibile in nero opaco.
- Horizontal steel bar for 4 lamps and/or lighting effects, 70 cm length, Ø 35 mm connection. Available in matt black.

PLH420

- Staffa zincata regolabile per truss con doppio accoppiatore singolo, adatta per tutte le truss quadrate e triangolari. Interasse regolabile da mm 195 a mm 405.
- Adjustable galvanized steel truss bracket with double coupler, suitable for any square or triangular truss.

PLSPN01

- Adattatore a vite in acciaio tornito (Ø 28 x 80 mm.) con bullone M12 x 25 mm. incorporato.
- Turned steel pin adapter (Ø 28 x 80 mm.) with built-in M12 x 25 mm bolt.

PLADT01

- Adattatore in alluminio pressofuso, adatto per supporto luci e per tutti gli stativi con tubo terminale da Ø 35 mm, con riduzione a Ø 28 mm. Colore nero.
- Die cast aluminium adapter, suitable for lighting stand and all other stands with Ø 35 mm end tube, with reduction to Ø 28 mm. Black colour.

PLKP182FL

- Flangia metallica di supporto per seguipersona applicabile su stativi con Ø 35 mm.
- Follow spot stand metal flange with spigot for Ø 35 mm stands.



PRO "KART" SERIES METAL SYSTEM



PROKARTM



PROKARTM

PROKARTM



PROKARTXL



PROKARTXL

PROKARTXL

Serie di carrelli portatili, compatti e pieghevoli, progettati per avere ampia versatilità d'uso per il trasporto delle attrezzature musicali per eventi live, per le attrezzature DJ e per molteplici altri utilizzi. Il telaio telescopico è realizzato in robusto acciaio tubolare verniciato a polveri epossidiche e sono dotati di pratiche e resistenti ruote, due fisse in gomma e due girevoli con freno in polipropilene, che permettono un trasporto facile e sicuro. Tutte le superfici di contatto sono ricoperte in morbido materiale antiscivolo.

Series of portable, compact and foldable trolleys, designed to have wide versatility of use for the transport of musical equipment for live events, for DJ equipment and for many other uses. The telescopic frame is made of sturdy steel tube painted with epoxy powders and with practical and sturdy wheels, two fixed rubber and two swiveling in polypropylene with brakes, which allow easy and safe transport. All contact surfaces are coated with soft anti-slip material.

PROKARTM

- Carrello di medie dimensioni, con superficie di carico variabile da un minimo di 585 ad un massimo di 850 mm. Portata di carico massima di 100 Kg. Colore nero.
- *Mid-sized trolley, with load surfaces ranging from a minimum of 585 to a maximum of 850 mm. Maximum load capacity of 100 Kg. Black colour.*

PROKARTXL

- Carrello di medie dimensioni, con superficie di carico variabile da un minimo di 735 ad un massimo di 1200 mm, con portata di carico massima di 200 Kg. Colore nero.
- *Large-sized trolley, with the loading surface variable from a minimum of 735 to a maximum of 1200 mm. Maximum load capacity of 200 Kg. Black colour.*

TECH INFO

| Model: | PROKARTM | PROKARTXL |
|------------------------------|--------------------------------|---------------------------------|
| Width | 585 – 850 mm (23.03" – 33.46") | 735 / 1200 mm (28.94" – 47.24") |
| Height (folded position) | 235 mm (9.25") | 280 mm (11.02") |
| Height (opened position) | 770 mm (30.31") | 1000 mm (39.37") |
| Depth (loading frame) | 280 mm (11.02") | 330 mm (12.99") |
| Depth (at large wheels side) | 380 mm (14.96") | 480 mm (18.90") |
| Weight | 8,3 Kg (18,30 lbs.) | 12,8 Kg (28,22 lbs.) |
| Master carton | 1 pc. | 1 pc. |

19" RACK STANDS "KR" SERIES

METAL SYSTEM



KR08



KR21PRO



KR08

- Supporto rack standard 19" da tavolo ad 8 unità, con tubi verticali inclinati. Disponibile in nero opaco.
- Desktop 8-unit 19" tilted rack stand. Available in matt black.

KR21PRO

- Supporto professionale rack da 19" a 21 unità. Questo innovativo supporto "multirack" contiene 9 unità in verticale e 12 nella parte superiore con inclinazione regolabile. Munito di n.4 ruote in metallo (due frenanti). Disponibile in nero.
- Professional 21U - 19" rack stand. This innovative "multirack" stand has 9 vertical unit and 12U on the tilt adjustable upper frame. It's equipped with four metal wheels (two with brake). Available in black.

TECH INFO

| | KR08 | KR21PRO |
|--------------------------|--------------------|----------------------|
| Model: | KR08 | KR21PRO |
| Width: | 530 mm (20.87") | 560 mm (22.05") |
| Height: | 470 mm (18.50") | 1180 mm (46.46") |
| Depth: | 390 mm (15.35") | 610 mm (24.01") |
| Weight: | 2.90 kg (6.39 lbs) | 13.60 kg (29.98 lbs) |
| Maximum load: | 20 kg (44.09 lbs) | 80 kg (176.37 lbs) |
| Available colors: | Black | Black |
| Master Carton: | 1 pc. | 1 pc. |

19" RACK CABINETS "STUDIORK" SERIES

METAL SYSTEM



STUDIORK08



STUDIORK12



STUDIORK18



STUDIORK24



19" RACK CABINETS "STUDIORK" SERIES

METAL SYSTEM



PXCover08N



PXCover12N



PXCover18N



PXCover24N



STUDIORK08 - STUDIORK12 - STUDIORK18 - STUDIORK24

- Supporti rack professionali da 19" con struttura in acciaio. Sono forniti con 4 ruote pivotanti e 4 piedini fissi regolabili da pavimento. Inoltre sono muniti di barre interne rinforzate con sezione ad "omega" che permettono l'alloggiamento di alette supplementari per il sostegno delle apparecchiature. Profondità utile interna 375 mm. Ideale per palchi, studi di registrazione o uso domestico. Disponibili in nero.
- Professional steel construction standard 19" rack stands. They include 4 swivel casters and 4 fixed feet adjustable from floor. Equipped with "omega" inner reinforced bars that allow the accommodation of additional flaps to hold the equipments. 375 mm rackable depth. Ideal for stage, recording studios or home applications. Available in black.

PXCover08N - PXCover12N - PXCover18N - PXCover24N

- Serie di porte anteriori realizzate in plexiglass con telaio in acciaio, design moderno e altamente tecnologico. La copertura frontale è un'utile protezione da polvere ed accessi indesiderati alle attrezzature. Il nuovo sistema di cerniere rende questo articolo adatto ai supporti della serie "STUDIORK" e "STUDIORKXL" e permette di applicare e rimuovere la porta in plexiglass, semplicemente azionando le cerniere a molla presenti all'interno del telaio. E' inclusa una chiusura di sicurezza con chiave.
- Series of steel frame/plexiglass construction front covers, modern and high-tech design. Front covers provides a useful protection against dust and undesirable access to equipment. The new hinge system makes these items suitable for "STUDIORK" and "STUDIORKXL" series stands, and allows the assembling and disassembling of the plexiglas cover by simply action on the inner metal frame spring loaded pins. They include a security lock with key.

TECH INFO

| Model: | STUDIORK08 | STUDIORK12 | STUDIORK18 | STUDIORK24 |
|-------------------|---------------------|---------------------|-------------------|---------------------|
| Base width: | 560 mm (22.05") | 560 mm (22.05") | 560 mm (22.05") | 560 mm (22.05") |
| Height: | 467 mm (18.39") | 646 mm (25.43") | 915 mm (36.02") | 1182 mm (46.54") |
| Base depth: | 460 mm (18.11") | 460 mm (18.11") | 460 mm (18.11") | 460 mm (18.11") |
| Internal depth: | 375 mm (14.76") | 375 mm (14.76") | 375 mm (14.76") | 375 mm (14.76") |
| Rack units: | 8 | 12 | 18 | 24 |
| Weight: | 17.9 kg (39.47 lbs) | 21.7 kg (47.85 lbs) | 27 kg (59.54 lbs) | 30.8 kg (67.91 lbs) |
| Available colors: | Black | Black | Black | Black |
| Master carton: | 1 pc. | 1 pc. | 1 pc. | 1 pc. |

TECH INFO

| Model: | PXCover08N | PXCover12N | PXCover18N | PXCover24N |
|----------------|--------------------|--------------------|--------------------|--------------------|
| Height: | 360 mm (14.17") | 540 mm (21.26") | 810 mm (31.89") | 1080 mm (42.51") |
| Rack Units: | 8 | 12 | 18 | 24 |
| Weight: | 1.35 kg (2.98 lbs) | 2.00 kg (4.41 lbs) | 2.95 kg (6.51 lbs) | 3.70 kg (8.16 lbs) |
| Master carton: | 6 pcs. | 6 pcs. | 6 pcs. | 6 pcs. |

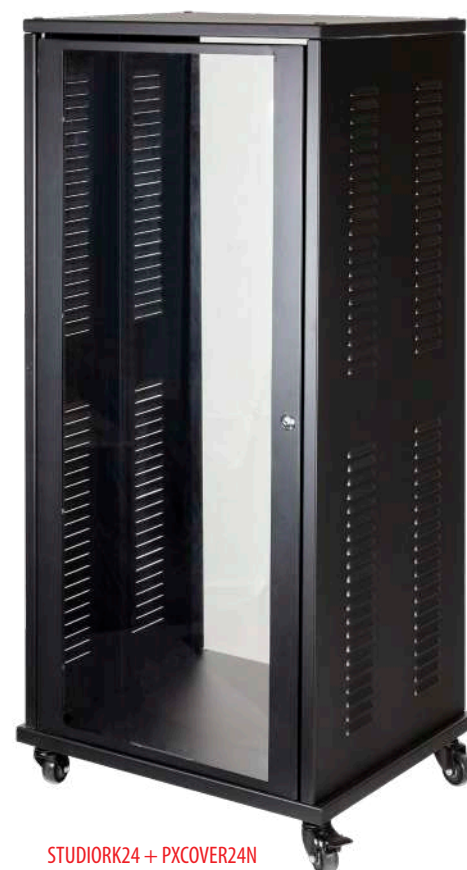

STUDIORK24 + PXCover24N

19" PROFESSIONAL RACK CABINETS "FSR" SERIES

METAL SYSTEM



FRSHELF02



feeding bar not included

FSR SERIES

• Armadi rack 19" - FSR Series - sono progettati per l'installazione in locali tecnici o in uffici dove l'estetica è un fattore molto importante. Ogni armadio ha il telaio, così come le pareti laterali (con serratura), il coperchio superiore e la porta posteriore (con serratura), in acciaio speciale, mentre la porta anteriore a battente (anche con serratura) è realizzata in vetro temperato con telaio sempre in acciaio. Sono inoltre dotati di 2 ripiani regolabili per le versioni a 37U e 32U, mentre le versioni a 27U, 22U, 16U, 12U ed 8U hanno un solo ripiano. È incluso anche un pannello superiore con 2 ventole di per l'aerazione, 4 ruote girevoli in metallo, 4 piedini regolabili, e una quantità di viti e dadi ingabbiati. Sono completi di n° 2 coppie (anteriore e posteriore) di montanti rack verticali a 19" con indicata la posizione per un agevole installazione delle apparecchiature. Gli armadi sono inoltre provvisti di ingresso cavi sul coperchio superiore e sulla base. Disponibili nella finitura nero opaco.

• 19" rack cabinets - FSR Series - are designed for installation in equipment rooms or in office environments where aesthetics are a factor. The frame, as well as the sides (with lock), the upper cover and the rear door (with lock), are made of special steel while the front hinged door (also with lock) is produced from toughened glass. It is also provided with 2 fixed shelves for 37U/32U, 1 fixed shelf for 27U/22U/16U/12U/8U, 2 fans with tray, 4 castors, 4 adjustable feet, and a quantity of install rack rail screws and cage nuts. The racks come complete with n° 2 pair (front and rear) of vertical rods to support the 19" components installed in the rack. The cabinets are equipped with a cable entrance on the top and bottom plates.

FRSHELF02

- Ripiano estraibile a rack 19", utilizzabile esclusivamente sugli armadi della nuova serie FSR. Finitura nero opaco.
- 19" rack metal sliding shelf to be used on the new FSR rack cabinets.

TECH INFO

| Model: | 19" Rack units | Height* | Width* | Depth* | Inner Depth |
|---------|----------------|------------------|-----------------|-----------------|-----------------|
| FSR2260 | 22 | 1093 mm (43.03") | 600 mm (23.62") | 600 mm (23.62") | 500 mm (19.69") |
| FSR2760 | 27 | 1313 mm (51.69") | 600 mm (23.62") | 600 mm (23.62") | 500 mm (19.69") |
| FSR3260 | 32 | 1533 mm (60.35") | 600 mm (23.62") | 600 mm (23.62") | 500 mm (19.69") |
| FSR3760 | 37 | 1753 mm (69.01") | 600 mm (23.62") | 600 mm (23.62") | 500 mm (19.69") |
| FSR4260 | 42 | 1973 mm (77.68") | 600 mm (23.62") | 600 mm (23.62") | 500 mm (19.69") |

*external dimensions

19" WALLMOUNT RACK CABINETS "WMRC" SERIES

METAL SYSTEM

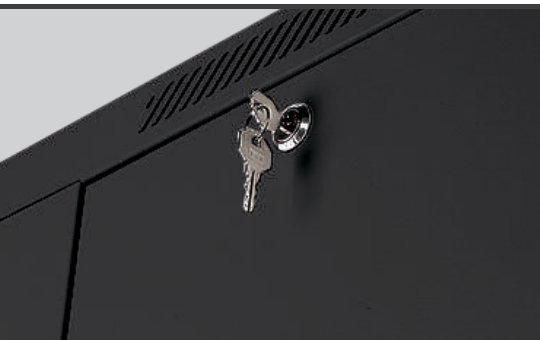

WMRCD6509



WMRC6606

WMRC SERIES

• Armadi modulari a rack 19" per installazione a parete realizzati in robusta lamiera stampata e con porta anteriore reversibile in vetro temperato. Dotati di ingresso cavi sulla parte superiore e inferiore e sono inoltre provvisti di pannelli laterali facilmente rimovibili (forniti con serratura). Sono completi di montanti rack 19" anteriori e posteriori. La porta d'ingresso può essere facilmente rimossa per un agevole installazione delle apparecchiature e successivamente reinserita senza richiedere l'uso di attrezzi. Disponibile nelle versioni a 6, 9 e 12 unità standard con finitura di colore nero opaco.

• Wall mount 19" rack modular cabinet series with tempered glass front locking door. It features cable entry on the top and bottom and quickly removable side panels provided of metal lock. It's also equipped with front and back adjustable mounting rails. The front door can be quickly removed for an easy equipments installation and re-hinged (no tools required). Available with 6, 9 and 12 standard units in black colour.

WMRCD SERIES

• Serie di armadi modulari a rack 19" per installazione a parete, con porta anteriore reversibile in vetro temperato. Realizzati in resistente lamiera stampata e telaio a doppia apertura per l'accesso posteriore al vano delle apparecchiature installate. Dotati di ingresso cavi sulla parte superiore e inferiore e sono inoltre provvisti di pannelli laterali facilmente rimovibili (forniti con serratura). Sono completi di montanti rack 19" anteriori e posteriori. La porta d'ingresso può essere facilmente rimossa per un agevole installazione delle apparecchiature e successivamente reinserita senza richiedere l'uso di attrezzi. Disponibile nelle versioni a 6, 9 e 12 unità standard con finitura di colore nero opaco.

• Wall mount 19" rack modular cabinet series with double opening sections and tempered glass front locking door. The double section provides an easy access to the rear side. It features cable entry on the top and bottom and quickly removable side panels provided of metal lock. It's also equipped with front and back adjustable mounting rails. The front door can be quickly removed for an easy equipments installation and re-hinged (no tools required). Available with 6, 9 and 12 standard units in black colour.

TECH INFO

| Model: | 19" Rack units | Height* | Width* | Depth* | Inner Depth | VOLUME |
|------------|----------------|-----------------|-----------------|-----------------|-----------------|----------------------------------|
| WMRC6606: | 6 | 370 mm (14.56") | 600 mm (23.62") | 600 mm (23.62") | 500 mm (19.69") | 0.150 m ³ (5.29 cuft) |
| WMRC6609: | 9 | 500 mm (19.68") | 600 mm (23.62") | 600 mm (23.62") | 500 mm (19.69") | 0.200 m ³ (7.06 cuft) |
| WMRC6612: | 12 | 635 mm (25.00") | 600 mm (23.62") | 600 mm (23.62") | 500 mm (19.69") | 0.252 m ³ (8.90 cuft) |
| WMRCD6506: | 6 | 370 mm (14.56") | 600 mm (23.62") | 600 mm (23.62") | 400 mm (15.79") | 0.138 m ³ (4.86 cuft) |
| WMRCD6509: | 9 | 500 mm (19.68") | 600 mm (23.62") | 600 mm (23.62") | 400 mm (15.79") | 0.184 m ³ (6.49 cuft) |
| WMRCD6512: | 12 | 635 mm (25.00") | 600 mm (23.62") | 600 mm (23.62") | 400 mm (15.79") | 0.232 m ³ (8.17 cuft) |

*external dimensions

19" RACK PANELS "RK" SERIES

METAL SYSTEM

• PANNELLI RACK 19" • Robusti pannelli in acciaio con spessore di 1,5 mm, per organizzare una vasta gamma di configurazioni a rack da 19" (pannelli ciechi, ventilati, forati, con griglie di protezione, in plexiglas). Ogni pannello é realizzato con una doppia piegatura a 90° (superiore - inferiore) per una maggiore robustezza. Verniciatura a polveri epossidiche con finitura gofrata in nero opaco.

• 19" RACK PANELS • Heavy duty 1,5mm steel panels, suiting a variety of 19" rack configurations (blank, vent, perforated, protection grid, plexiglas panels). Each panel features a double 90° fold (upper - lower) for additional ruggedness. Black epoxy powder paint finish with external peel surface.



RK1L

- Pannello cieco 1 unità rack da 19".
- 1-unit 19" blank rack panel.

RK2L

- Pannello cieco 2 unità rack da 19".
- 2-unit 19" blank rack panel.

RK3L

- Pannello cieco 3 unità rack da 19".
- 3-unit 19" blank rack panel.

RK4L

- Pannello cieco 4 unità rack da 19".
- 4-unit 19" blank rack panel.

VENTILATION 19" RACK PANELS



RK1NV

- Pannello ventilato 1 unità rack da 19".
- 1-unit 19" vent rack panel.



RK2NV

- Pannello ventilato 2 unità rack da 19".
- 2-unit 19" vent rack panel.

PRE-DRILLED & SECURITY 19" RACK PANELS - RK SERIES

METAL SYSTEM



RK4N

- Pannello forato ad 1 unità rack da 19", con 4 fori di montaggio per connettori da incasso XLR/SPEAKON (Ø 24 mm).
- 1-unit 19" perforated rack panel with N. 4 mounting holes for XLR/SPEAKON panel mount connectors (ø 24 mm).



RK6N

- Pannello forato ad 1 unità rack da 19", con 6 fori di montaggio per connettori da incasso XLR/SPEAKON (Ø 24 mm).
- 1-unit 19" perforated rack panel with N. 6 mounting holes for XLR/SPEAKON panel mount connectors (ø 24 mm).



RK8N

- Pannello forato ad 1 unità rack da 19", con 8 fori di montaggio per connettori da incasso XLR/SPEAKON (Ø 24 mm).
- 1-unit 19" perforated rack panel with N. 8 mounting holes for XLR/SPEAKON panel mount connectors (ø 24 mm).



RK12N

- Pannello forato ad 1 unità rack da 19", con 12 fori di montaggio per connettori da incasso XLR/SPEAKON (Ø 24 mm).
- 1-unit 19" perforated rack panel with N. 12 mounting holes for XLR/SPEAKON panel mount connectors (ø 24 mm).



RK16N

- Pannello forato ad 1 unità rack da 19", con 16 fori di montaggio per connettori da incasso XLR (Ø 24 mm).
- 1-unit 19" perforated rack panel with N. 16 mounting holes for XLR panel mount connectors (ø 24 mm).

SECURITY 19" RACK PANELS



RK1MG

- Pannello di protezione/sicurezza ad 1 unità rack da 19", con rete metallica anti-intrusione.
- 1-unit 19" protection/safety rack panel with anti intrusion metallic grid.

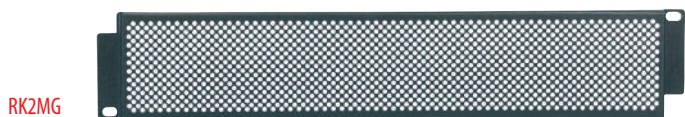

RK2MG

- Pannello di protezione/sicurezza a 2 unità rack da 19", con rete metallica anti-intrusione.
- 2-unit 19" protection/safety rack panel with anti intrusion metallic grid.



RK1PX

- Pannello di protezione/sicurezza ad 1 unità rack da 19", con corpo metallico e finestra di ispezione in plexiglas.
- 1-unit 19" protection/safety rack panel with metal body and plexiglas inspection window.

19" SECURITY PANELS & RACK SHELVES "RK" SERIES

METAL SYSTEM

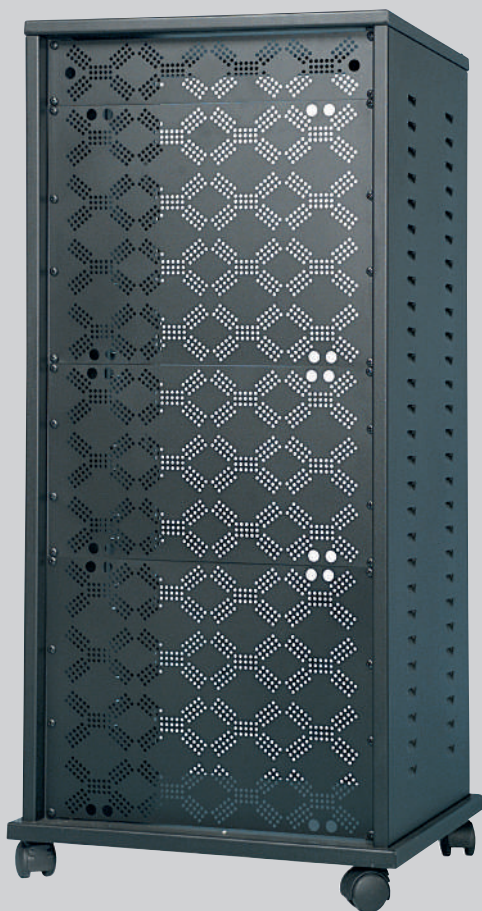

RK2VP

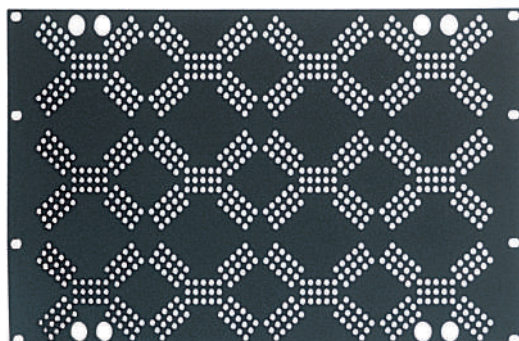

RK6VP

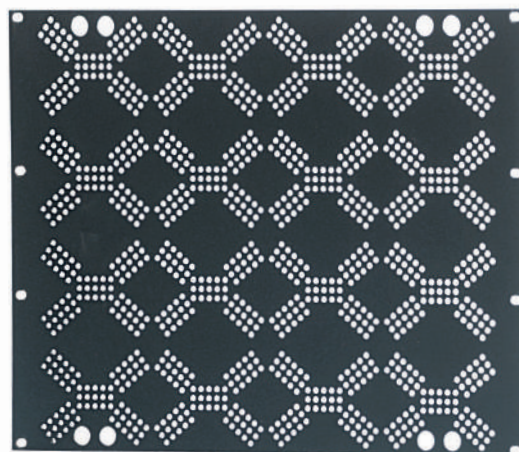

RK8VP

RK2VP RK6VP RK8VP

- Pannelli rack di sicurezza a rete per proteggere le apparecchiature da manomissioni. Disponibili per 2, (RK2VP), 6 (RK6VP) e 8 unità rack (RK8VP). Finitura nero gofrato.
- Rack panels with gridded protection against equipment tampering. Available with 2 (RK2VP), 6 (RK6VP) and 8 (RK8VP) rack units. Available in matt black.

19" RACK SHELVES "ADRK" SERIES



ADRK1AZ

ADRK1AZ

- Ripiano ad 1 unità rack da 19" realizzato con lamiera in acciaio da 1,5 mm di spessore con foratura universale per l'alloggiamento di apparecchiature sprovviste di attacco rack. Profondità utile 254 mm. Confezione standard: 10 pezzi.
- 19" - 1U universal rack shelf made of 1.5mm thickness steel plate with holes for accommodation of non-19" mounting equipment. 254 mm available depth. Master pack: 10 pcs.



ADRK2AZ

ADRK2AZ

- Ripiano a 2 unità rack da 19" realizzato con lamiera in acciaio da 1,5 mm di spessore con foratura universale per l'alloggiamento di apparecchiature sprovviste di attacco rack. Profondità utile 371 mm. Confezione standard: 6 pezzi.
- 19" - 2U universal rack shelf made of 1.5mm thickness steel plate with holes for accommodation of non-19" mounting equipment. 371 mm available depth. Master pack: 6 pcs.



ADRK3AZ

ADRK3AZ

- Ripiano a 3 unità rack da 19" realizzato con lamiera in acciaio da 1,5 mm di spessore con foratura universale per l'alloggiamento di apparecchiature sprovviste di attacco rack. Profondità utile 371 mm. Confezione standard: 2 pezzi.
- 19" - 3U universal rack shelf made of 1.5mm thickness steel plate with holes for accommodation of non-19" mounting equipment. 371 mm available depth. Master pack: 2 pcs.

19" RACK DRAWERS AND SHELVES - ADRK SERIES

METAL SYSTEM



ADRK2CR



ADRK2CRSH



ADRK3CR



ADRK3CRSH



ADRK4CR

ADRK2CRSH - ADRK3CRSH

- Cassetto rack da 19" in acciaio verniciato con guide telescopiche zincate. Larghezza interna: 405 mm. **Profondità interna: 210 mm.** Disponibile nelle versioni a 2 e, 3 unità in altezza. Finitura nero goffrato. Confezione standard 1 pezzo.
- Lockable 19" steel construction metal drawer with telescopic zinc plated slides. Inner width: 405 mm. **Inner depth: 210 mm.** Available in 2U and 3U. Black finishing. Master pack: 1 pc.

ADRK2CR - ADRK3CR - ADRK4CR

- Cassetto rack da 19" in acciaio verniciato con guide telescopiche zincate. Larghezza interna: 405 mm. **Profondità interna: 340 mm.** Disponibile nelle versioni a 2, 3 e 4 unità in altezza. Finitura nero goffrato. Confezione standard 1 pezzo.
- Lockable 19" steel construction metal drawer with telescopic zinc plated slides. Inner width: 405 mm. **Inner depth: 340 mm.** Available in 2U, 3U and 4U w. Black finishing. Master pack: 1 pc.

19" RACK PULL-OUT SHELVES



ADRK1PE



ADRK2PE

ADRK1PE

- Struttura ad 1 unità rack da 19" con piano estraibile costruita con lamiere in acciaio e munita di guide zincate laterali. Profondità utile del piano: 379 mm. Profondità d'installazione: Min. 382 mm – Max 510 mm. Finitura nero goffrato. Confezione standard: 6 pezzi.
- 19" – 1U rackmount pull-out shelf made of steel sheets and fitted with galvanized side guides. Inner surface depth: 379 mm. Installation depth: min. 382 mm - 510 mm Max. Black finish. Master pack: 6 pcs.

ADRK2PE

- Struttura ad 1 unità rack da 19" con piano estraibile costruita con lamiere in acciaio e munita di guide zincate. Profondità utile: 315 mm. Finitura nero goffrato. Confezione standard: 1 pezzo.
- 19" – 1U rackmount pull-out shelf, made of steel plate and equipped with zinc plated sliding bars. Useable depth 315mm. Black finish. Master pack: 1 pc.

19" RACK ACCESSORIES

METAL SYSTEM



KIT12



KIT12B

KIT12

• Set completo per rack composto da 12 viti (M6 x 10), 12 rondelle & 12 dadi zincati con gabbia per rack. Confezione standard: 10 set.

• 12 Screw (M6 x 10), 12 washer & 12 galvanized cage washer complete set for rack. Master pack: 10 set.

KIT12B

• Set completo per rack composto da 12 viti (M6 x 25), 12 rondelle e 12 dadi zincati con gabbia. Confezione standard: 10 set.

• 12 screw (M6 x 25), 12 washer and 12 galvanized cage washer complete set for rack. Master pack: 10 set.



PRO CABLES

• I cavi professionali PROEL da anni rappresentano per il mercato internazionale sinonimo di qualità, funzionalità e versatilità. Qualsiasi sia il tipo di collegamento da effettuare (strumento, mixer, microfono, speaker, MIDI, digitale, ecc.) troverete il cavo PROEL più adatto alle vostre esigenze. PROEL grazie alla scelta dei materiali di assemblaggio di prima qualità e all'impiego della più alta tecnologia costruttiva, assicura il massimo livello qualitativo disponibile oggi sul mercato.

• *PROEL professional cables have been synonymous for quality, functionality and versatility on the international market for many years. Whatever the type of connection required (musical instrument, mixer, microphone, speaker, MIDI, digital, computer, etc.), you will find the suitable PROEL cable for your needs. Thanks to its first choice assembly materials and the use of the most advanced manufacturing technology, PROEL grants the highest quality level available in today's market.*



PROFESSIONAL ASSEMBLED CABLES "PRODUCTS RANGE"

PRO CABLES

• PROEL, forte della sua pluriennale esperienza nel settore delle connessioni, è in grado di offrire un vasta gamma di prodotti per soddisfare le più svariate esigenze del mondo dello spettacolo. Di seguito viene riportato un elenco delle principali famiglie di cavi assemblati standard gestiti. Se non trovate il prodotto che soddisfa le vostre esigenze, non esitate a contattare il nostro staff aziendale che è a vostra disposizione per ogni chiarimento e per valutare eventuali richieste particolari. La preparazione e la professionalità dei nostri tecnici, unita alla disponibilità del personale commerciale e alla sensibilità verso la clientela, rendono possibile la realizzazione di prodotti custom dedicati che seguono l'iter che va dalla progettazione all'assistenza post-vendita, e che garantiscono la soddisfazione dell'utente finale.

• PROEL has for many years been recognised as a manufacturer of high quality connection systems, able to provide a vast range of products to satisfy the most demanding and specific requirements for the world of entertainment. The following sections highlights the more commonly requested connection systems which make up our standard production. Should there be a type of cable or connector system that you require that cannot be found here, please do not hesitate to contact us with your request. Our professional team of technicians will be happy to work together with you to create a customised product to meet your needs. With dedicated assistance from the system design through to after-sales service, we can guarantee the satisfaction of even the most demanding end-user

INSTRUMENT ASSEMBLED CABLES

| | | |
|---------------------------|------|-----|
| "ESOTERIC" Series | pag. | 75 |
| "CHALLENGE" Series | pag. | 83 |
| "BRAVE" Series | pag. | 93 |
| "STAGE INNOVATION" Series | pag. | 97 |
| "BULK" Series | pag. | 102 |

UNBALANCED ASSEMBLED CABLES

| | | |
|---------------------------|------|-----|
| "ESOTERIC" Series | pag. | 76 |
| "CHALLENGE" Series | pag. | 83 |
| "STAGE INNOVATION" Series | pag. | 98 |
| "BULK" Series | pag. | 102 |

BALANCED ASSEMBLED CABLES

| | | |
|---------------------------|------|-----|
| "ESOTERIC" Series | pag. | 76 |
| "CHALLENGE" Series | pag. | 84 |
| "BRAVE" Series | pag. | 95 |
| "STAGE INNOVATION" Series | pag. | 98 |
| "BULK" Series | pag. | 103 |

PATCH ASSEMBLED CABLES

| | | |
|---------------------------|------|-----|
| "ESOTERIC" Series | pag. | 76 |
| "CHALLENGE" Series | pag. | 84 |
| "STAGE INNOVATION" Series | pag. | 99 |
| "BULK" Series | pag. | 103 |
| "SPB" Series | pag. | 118 |

DMX ASSEMBLED CABLES

| | | |
|---------------------------|------|-----|
| "ESOTERIC" Series | pag. | 81 |
| "CHALLENGE" Series | pag. | 85 |
| "STAGE INNOVATION" Series | pag. | 100 |
| "BULK" Series | pag. | 106 |

MIDI ASSEMBLED CABLES

| | | |
|--------------------|------|-----|
| "CHALLENGE" Series | pag. | 85 |
| "BULK" Series | pag. | 103 |

PASSIVE SPEAKER ASSEMBLED CABLES

| | | |
|---------------------------|------|----|
| "ESOTERIC" Series | pag. | 80 |
| "STAGE INNOVATION" Series | pag. | 99 |

ACTIVE SPEAKER ASSEMBLED CABLES

| | | |
|-------------|------|-----|
| "PH" Series | pag. | 108 |
|-------------|------|-----|

COMBI DMX + POWER ASSEMBLED CABLES

| | | |
|-----------------|------|-----|
| "PH DMX" Series | pag. | 111 |
|-----------------|------|-----|

PROFESSIONAL AUDIO INTERCONNECTS

"ADAPTER"- "INSERT"- "Y"- "EXTENSION"- "STEREO/L/R"

| | | |
|--------------------|------|-----|
| "CHALLENGE" Series | pag. | 86 |
| "BULK" Series | pag. | 104 |

PROFESSIONAL STUDIO LOOMS

| | | |
|---------------------------|------|---------|
| "CHALLENGE" Series | pag. | 79 |
| "ESOTERIC" Series | pag. | 111&113 |
| "STAGE INNOVATION" Series | pag. | 112&114 |

PROFESSIONAL VIDEO CABLES & ADAPTERS

| | | |
|--------------------------------|------|-----|
| "BULK" Series - HDMI | pag. | 106 |
| "BULK" Series - VGA | pag. | 106 |
| "BULK" Series - VIDEO ADAPTERS | pag. | 107 |

PROFESSIONAL NETWORK CABLES

| | | |
|--------------------|------|-----|
| "AVCAT PRO" Series | pag. | 115 |
| "CAT PRO" Series | pag. | 117 |

POWER ASSEMBLED CABLES

| | | |
|-------------|------|-----|
| "SM" Series | pag. | 118 |
|-------------|------|-----|

ACCESSORIES

| | | |
|--------------|------|-----|
| Cable tester | pag. | 118 |
| Velcro Ties | pag. | 119 |



Made in Italy



Proel Connector



Neutrik Connector



YongSheng Connector



Hirose Connector



Cable Jacket Color



MAIN ASSEMBLING INSTRUCTIONS

PRO CABLES

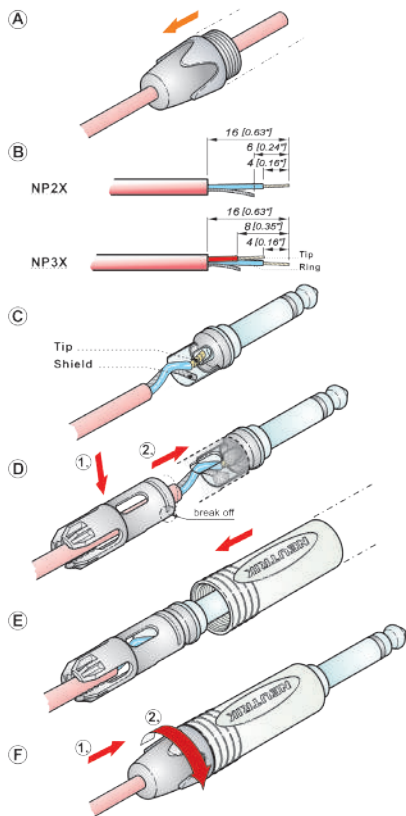

JACK

- A)** Inserire il passacavo sul cavo.
- B)** Preparare il cavo come indicato.
- C)** Saldare le estremità del cavo.
- D)** Inserire la pinza del connettore ed allinearla alla spina.

Attenzione:

Se si ura un cavo con Ø esterno 5.50 mm [0.216"] togliere questa parte della pinza.

- E)** Inserire il corpo del connettore sulla spina.
- F)** Terminare l'installazione serrando il connettore con il passacavo.

JACK

- A)** Slide the boot onto the cable.
- B)** Prepare cable as shown.
- C)** Solder the wire ends.
- D)** Position the chuck onto the cable and align chuck with plugfinger.

Attention:

If using a cable with O.D. > 5.50 mm [0.216"] break away this part of the chuck.

- E)** Slide the housing onto the plugfinger with the chuck.
- F)** Finish the installation by tighten the bushing onto the connector.

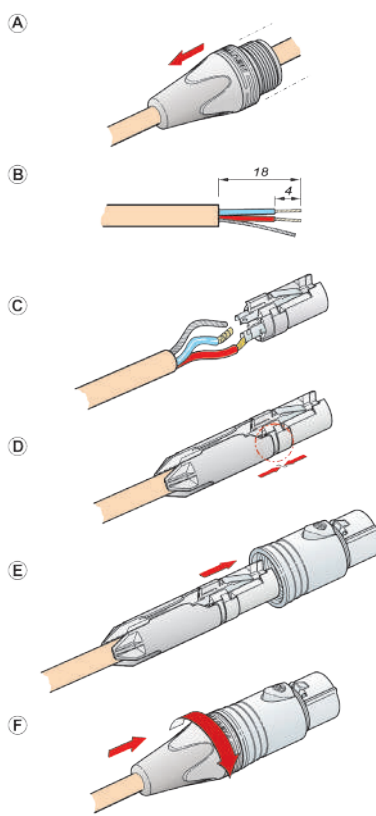

XLR

- A)** Inserire il passacavo sul cavo.
- B)** Preparare il cavo come indicato.
- C)** Inserire i conduttori all'interno dei terminali e procedere alla saldatura.
- D)** Inserire la pinza sul cavo.

Attenzione: Allineare la pinza al connettore come indicato.

- E)** Inserire l'inserto e la pinza all'interno del corpo connettore.
- F)** Terminare l'installazione serrando il corpo connettore con il passacavo.

XLR

- A)** Slide the boot onto the cable.
- B)** Prepare cable as shown.
- C)** Insert wires into the terminals and solder them.
- D)** Put chuck onto the cable.

Attention: Pay attention to the guiding key.

- E)** Slide insert and chuck together into the housing.
- F)** Finish the installation by turning the bushing onto the connector.

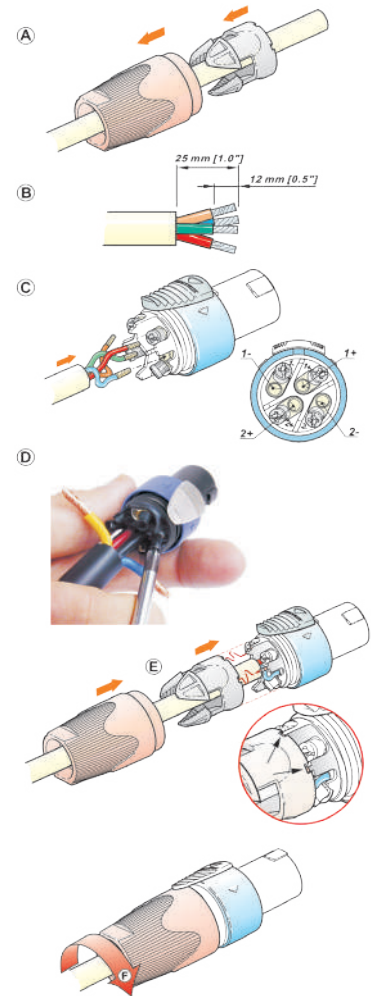

SPEAKON

- A)** Inserire il passacavo sul cavo.
- B)** Preparare il cavo come indicato.

Importante: rispettare le lunghezze di 25 mm e 12 mm.

- C)** Inserire i conduttori all'interno dei terminali e serrare le viti.
- D)** Per un veloce assemblaggio specialmente con cavi di grandi dimensioni prima inserire i contatti 1+ e 2+ dopodichè gli altri contatti 1- e 2-.
- E)** Inserire la pinza sul corpo connettore.

Importante: allineare le estremità della pinza ai punti di contatto predisposti.

- F)** Terminare l'installazione serrando il corpo connettore con il passacavo.

SPEAKON

- A)** Place bushing and chuck over cable.
- B)** Prepare cable as shown.

Important is the stripping length of 25 mm and 12 mm.

- C)** Insert wires into terminals and secure clamp terminals with screw driver.
- D)** For easy wiring especially on big cables, first screw on the inner contacts 1+ and 2+ and afterwards the outer contacts 1- and 2-!
- E)** Push chuck up to housing.

Important: Align the chuck by positioning the nose into the recess.

- F)** Tighten the bushing

PROFESSIONAL PREMADE CABLES "ESOTERIC" SERIES

PRO CABLES

ESOTERIC

• La serie di cavi assemblati "ESO" rappresenta la pura essenza del suono privo di qualsiasi distorsione o disturbo, in quanto frutto di un processo tecnologico completamente automatizzato che combina cavi di altissima qualità con i migliori e più affidabili connettori professionali Neutrik. PROEL ha sviluppato la serie "ESO" per soddisfare le richieste dei professionisti che pretendono sempre un segnale puro, preciso ed affidabile. I cavi, infatti, sono completamente realizzati in rame stagnato puro al 100%, garantendo una capacità bassissima e quindi un segnale perfettamente puro ed integro. Inoltre, ogni cavo viene testato da speciali macchinari computerizzati, in modo da assicurare sempre qualità e performance. Già riconosciuta leader internazionale del settore, la serie "ESO" è di fatto il nome di riferimento per tutte le applicazioni audio professionali sia fisse che mobili e rappresenta la scelta ideale per le nuove realtà digitali.

• "ESOTERIC" Series premade cables represent the pure essence of sound free of any distortion or interference, being the result of a completely automated technological process combining highest quality cables and Neutrik's best and most reliable professional connectors. PROEL has developed the "ESOTERIC" series to meet professionals requirements of a pure, accurate and reliable signal. All cables are completely realized in 100% pure copper in order to grant a very low capacitance and a perfectly sharp and intact signal. Each cable is mechanically and electronically tested in order to guarantee quality and performance. "ESO" series, already recognized as an international leader in its field, is the reference name for any professional audio application, both fixed and mobile, and it represents the ideal partner for the new digital realities.



NEUTRIK

Instrument Cables 75



Unbalanced Cables 76

Balanced Cables 76



Passive Speaker Cables 80



DMX Cables 81



Studio Looms 111



PROFESSIONAL INSTRUMENT CABLES "ESOTERIC" SERIES

PRO CABLES

ES0100



• Cavo professionale per strumenti con connessioni spina jack Mono Ø 6.3 mm Neutrik/ NP2X - HPC110BK - NP2X. Colore disponibile: BK.

• Professional instrument cable with Neutrik Ø 6.3 mm Mono jack plug - Neutrik Ø 6.3 mm Mono jack plug connections / NP2X - HPC110BK - NP2X. Available colour: BK.

| CODE | LENGHT |
|------------|-----------------|
| ES0100LU3 | 3 m (9.84 ft) |
| ES0100LU5 | 5 m (16.40 ft) |
| ES0100LU6 | 6 m (19.69 ft) |
| ES0100LU10 | 10 m (32.81 ft) |



HPC110



ES0120



• Cavo professionale per strumenti con connessioni spina jack Mono Ø 6.3 mm Neutrik - spina jack Mono Ø 6.3 mm ad angolo Neutrik/NP2X - HPC110BK - NP2RX. Colore disponibile: BK.

• Professional instrument cable with Neutrik Ø 6.3 mm Mono jack plug - Neutrik Ø 6.3 mm right angle Mono jack plug connections / NP2X - HPC110BK - NP2RX. Available colour: BK.

| CODE | LENGHT |
|-----------|----------------|
| ES0120LU3 | 3 m (9.84 ft) |
| ES0120LU5 | 5 m (16.40 ft) |
| ES0120LU6 | 6 m (19.69 ft) |



HPC110



ES0130



• Cavo professionale esoterico per strumenti con connessioni spina jack Mono Ø 6.3 mm Neutrik/NP2X - HPC130 - NP2X. Colore disponibile: BK.

• Esoteric professional instrument cable with Neutrik Ø 6.3 mm Mono jack plug - Neutrik Ø 6.3 mm Mono jack plug connections/NP2X - HPC130 - NP2X. Available colour: BK.

| CODE | LENGHT |
|------------|------------------|
| ES0130LU1 | 1 mt (3.28 ft) |
| ES0130LU3 | 3 mt (9.84 ft) |
| ES0130LU5 | 5 mt (16.40 ft) |
| ES0130LU6 | 6 mt (19.69 ft) |
| ES0130LU10 | 10 mt (32.81 ft) |



HPC130



ES0135



• Cavo professionale esoterico per strumenti con connessioni spina jack Mono Ø 6.3 mm Neutrik - spina jack Mono Ø 6.3 mm ad angolo Neutrik/NP2X - HPC130 - NP2RX. Colore disponibile: BK.

• Esoteric professional instrument cable with Neutrik Ø 6.3 mm Mono jack plug - Neutrik Ø 6.3 mm right angle Mono jack plug connections/NP2X - HPC130 - NP2RX. Available colour: BK.

| CODE | LENGHT |
|------------|------------------|
| ES0135LU1 | 1 mt (3.28 ft) |
| ES0135LU3 | 3 mt (9.84 ft) |
| ES0135LU5 | 5 mt (16.40 ft) |
| ES0135LU6 | 6 mt (19.69 ft) |
| ES0135LU10 | 10 mt (32.81 ft) |



HPC130



ES0145



• Cavo professionale esoterico per strumenti con connessioni spina jack Mono Ø 6.3 mm SILENT ad angolo Neutrik - spina jack Mono Ø 6.3 mm Neutrik/NP2RXAU - HPC130 - NP2XB. Colore disponibile: BK.

• Esoteric professional instrument cable with Neutrik Ø 6.3 mm right angle "SILENT" Mono jack plug - Neutrik Ø 6.3 mm Mono jack plug connections/NP2RXAU - HPC130 - NP2XB. Available colour: BK.

| CODE | LENGHT |
|-----------|-----------------|
| ES0145LU3 | 3 mt (9.84 ft) |
| ES0145LU5 | 5 mt (16.40 ft) |
| ES0145LU6 | 6 mt (19.69 ft) |



HPC130



PROFESSIONAL UNBALANCED CABLES "ESOTERIC" SERIES

PRO CABLES

ES0235



- Cavo professionale esoterico sbilanciato con connessioni spina jack Mono Ø 6.3 mm Neutrik - spina volante XLR 3P Neutrik/NP2X - HPC250 - NC3MXX. Colore disponibile: BK.
- Cavo professionale esoterico sbilanciato con connessioni spina jack Mono Ø 6.3 mm Neutrik - spina volante XLR 3P Neutrik/NP2X - HPC250 - NC3MXX. Colore disponibile: BK.

| CODE | LENGHT |
|------------|------------------|
| ES0235LU3 | 3 mt (9.84 ft) |
| ES0235LU5 | 5 mt (16.40 ft) |
| ES0235LU10 | 10 mt (32.81 ft) |



HPC250



ES0250



- Cavo professionale esoterico sbilanciato con connessioni spina jack Mono Ø 6.3 mm Neutrik - presa volante XLR 3P Neutrik/NP2X - HPC250 - NC3FXX. Colore disponibile: BK.
- Esoteric professional unbalanced cable with Neutrik Ø 6.3 mm Mono jack plug - Neutrik XLR 3P female cable mount connections/NP2X - HPC250 - NC3FXX. Available colour: BK.

| CODE | LENGHT |
|------------|------------------|
| ES0250LU3 | 3 mt (9.84 ft) |
| ES0250LU5 | 5 mt (16.40 ft) |
| ES0250LU10 | 10 mt (32.81 ft) |



HPC250



PROFESSIONAL BALANCED CABLES "ESOTERIC" SERIES

ES0230



- Cavo professionale esoterico bilanciato con connessioni spina jack Stereo Ø 6.3 mm Neutrik/NP3X - HPC250 - NP3X. Colore disponibile: BK.
- Esoteric professional balanced cable with Neutrik Ø 6.3 mm Stereo jack plug - Neutrik Ø 6.3 mm Stereo jack plug connections/NP3X - HPC250 - NP3X. Available colour: BK.

| CODE | LENGHT |
|------------|------------------|
| ES0230LU05 | 0,5 mt (1.64 ft) |
| ES0230LU1 | 1 mt (3.28 ft) |
| ES0230LU2 | 2 mt (6.56 ft) |
| ES0230LU3 | 3 mt (9.84 ft) |
| ES0230LU5 | 5 mt (16.40 ft) |
| ES0230LU10 | 10 mt (32.81 ft) |



HPC250



ES0240



- Cavo professionale esoterico bilanciato con connessioni spina jack Stereo Ø 6.3 mm Neutrik - spina volante XLR 3P Neutrik/NP3X - HPC250 - NC3MXX. Colore disponibile: BK.
- Esoteric professional balanced cable with Neutrik Ø 6.3 mm Stereo jack plug - Neutrik XLR 3P male cable mount connections/NP3X - HPC250 - NC3MXX. Available colour: BK.

| CODE | LENGHT |
|------------|------------------|
| ES0240LU1 | 1 mt (3.28 ft) |
| ES0240LU2 | 2 mt (6.56 ft) |
| ES0240LU3 | 3 mt (9.84 ft) |
| ES0240LU5 | 5 mt (16.40 ft) |
| ES0240LU10 | 10 mt (32.81 ft) |



HPC250



ES0245



- Cavo professionale esoterico bilanciato con connessioni spina jack Stereo Ø 6.3 mm Neutrik - presa volante XLR 3P Neutrik/NP3X - HPC250 - NC3FXX. Colore disponibile: BK.
- Esoteric professional balanced cable with Neutrik Ø 6.3 mm Stereo jack plug - Neutrik XLR 3P female cable mount connections/NP3X - HPC250 - NC3FXX. Available colour: BK.

| CODE | LENGHT |
|------------|------------------|
| ES0245LU1 | 1 mt (3.28 ft) |
| ES0245LU3 | 3 mt (9.84 ft) |
| ES0245LU5 | 5 mt (16.40 ft) |
| ES0245LU10 | 10 mt (32.81 ft) |



HPC250



• Custom lengths are available on request

PROFESSIONAL BALANCED CABLES "ESOTERIC" SERIES

PRO CABLES

ES0210



• Cavo professionale bilanciato con connessioni presa volante XLR 3P Neutrik - spina volante XLR 3P Neutrik / NC3FXX - HPC210BK - NC3MXX. Colore disponibile: BK.

• Professional balanced cable with Neutrik XLR 3P female cable mount - Neutrik XLR 3P male cable mount connections / NC3FXX - HPC210BK - NC3MXX. Available colour: BK.

| CODE | LENGHT |
|------------|------------------|
| ES0210LU05 | 0,5 mt (1.64 ft) |
| ES0210LU1 | 1 mt (3.28 ft) |
| ES0210LU2 | 2 mt (6.56 ft) |
| ES0210LU3 | 3 mt (9.84 ft) |
| ES0210LU5 | 5 mt (16.40 ft) |
| ES0210LU6 | 6 mt (19.69 ft) |
| ES0210LU10 | 10 mt (32.81 ft) |
| ES0210LU15 | 15 mt (49.21 ft) |
| ES0210LU20 | 20 mt (65.62 ft) |



HPC210



ES0210WH



• Cavo professionale bilanciato con connessioni presa volante XLR 3P Neutrik - spina volante XLR 3P Neutrik / NC3FXXWT - HPC210WH - NC3MXXWT. Colore disponibile: WH.

• Professional balanced cable with Neutrik XLR 3P female cable mount - Neutrik XLR 3P male cable mount connections / NC3FXXWT - HPC210WH - NC3MXXWT. Available colour: WH.

| CODE | LENGHT |
|--------------|------------------|
| ES0210LU3WH | 3 mt (9.84 ft) |
| ES0210LU5WH | 5 mt (16.40 ft) |
| ES0210LU6WH | 6 mt (19.69 ft) |
| ES0210LU10WH | 10 mt (32.81 ft) |



HPC210WH



ES0225 NEW



• Cavo professionale bilanciato con connessioni presa volante XLR 3P Neutrik ad angolo - spina volante XLR 3P Neutrik / NC3FRX - HPC210BK - NC3MXX. Colore disponibile: BK.

• Professional balanced cable with Neutrik right angle XLR 3P female cable mount - Neutrik XLR 3P male cable mount connections / NC3FRX - HPC210BK - NC3MXX. Available colour: BK.

| CODE | LENGHT |
|------------|------------------|
| ES0225LU05 | 0,5 mt (1.64 ft) |
| ES0225LU1 | 1 mt (3.28 ft) |
| ES0225LU2 | 2 mt (6.56 ft) |
| ES0225LU3 | 3 mt (9.84 ft) |
| ES0225LU5 | 5 mt (16.40 ft) |
| ES0225LU6 | 6 mt (19.69 ft) |
| ES0225LU10 | 10 mt (32.81 ft) |
| ES0225LU15 | 15 mt (49.21 ft) |
| ES0225LU20 | 20 mt (65.62 ft) |



HPC210



ES0215G



• Cavo professionale bilanciato con connessioni presa volante XLR 3P nero Neutrik - spina volante XLR 3P nero Neutrik con contatti dorati / NC3FXXB - HPC210BK - NC3MXXB. Colore disponibile: BK.

• Professional balanced cable with Neutrik black XLR 3P female cable mount - Neutrik black XLR 3P male cable mount connections with gold contacts / NC3FXXB - HPC210BK - NC3MXXB. Available colour: BK.

| CODE | LENGHT |
|-------------|------------------|
| ES0215LU01G | 1 mt (3.28 ft) |
| ES0215LU02G | 2 mt (6.56 ft) |
| ES0215LU03G | 3 mt (9.84 ft) |
| ES0215LU05G | 5 mt (16.40 ft) |
| ES0215LU06G | 6 mt (19.69 ft) |
| ES0215LU10G | 10 mt (32.81 ft) |
| ES0215LU15G | 15 mt (49.21 ft) |
| ES0215LU20G | 20 mt (65.62 ft) |
| ES0215LU30G | 30 mt (98.42 ft) |



HPC210



PROFESSIONAL BALANCED CABLES "ESOTERIC" SERIES

PRO CABLES

ES0255



- Cavo professionale esoterico bilanciato con connessioni presa volante XLR 3P Neutrik - spina volante XLR 3P Neutrik/ NC3FXX - HPC250 - NC3MXX. Colore disponibile: BK.
- *Esoteric professional balanced cable with Neutrik XLR 3P female cable mount - Neutrik XLR 3P male cable mount connections/NC3FXX - HPC250 - NC3MXX. Available colour: BK.*

| CODE | LENGHT |
|------------|------------------|
| ES0255LU05 | 0,5 mt (1.64 ft) |
| ES0255LU1 | 1 mt (3.28 ft) |
| ES0255LU2 | 2 mt (6.56 ft) |
| ES0255LU3 | 3 mt (9.84 ft) |
| ES0255LU5 | 5 mt (16.40 ft) |
| ES0255LU6 | 6 mt (19.69 ft) |
| ES0255LU10 | 10 mt (32.81 ft) |
| ES0255LU15 | 15 mt (49.21 ft) |
| ES0255LU20 | 20 mt (65.62 ft) |



HPC250



ES0280



- Cavo professionale esoterico bilanciato con connessioni presa volante XLR 3P Neutrik - spina volante XLR 3P Neutrik con cavo microfonico 2 x 0,34mm2 / NC3FXX - HPC280 - NC3MXX. Colore disponibile BK.
- *Esoteric professional balanced cable with Neutrik XLR 3P female cable mount - Neutrik XLR 3P male cable mount connections and 2 x 0,34 mm2 microphone cable/NC3FXX - HPC280 - NC3MXX. Available colour: BK.*

| CODE | LENGHT |
|------------|------------------|
| ES0280LU1 | 1 mt (3.28 ft) |
| ES0280LU2 | 2 mt (6.56 ft) |
| ES0280LU3 | 3 mt (9.84 ft) |
| ES0280LU5 | 5 mt (16.40 ft) |
| ES0280LU6 | 6 mt (19.69 ft) |
| ES0280LU10 | 10 mt (32.81 ft) |
| ES0280LU15 | 15 mt (49.21 ft) |
| ES0280LU20 | 20 mt (65.62 ft) |



HPC280



ES0285 NEW



- Cavo professionale bilanciato con connessioni presa volante XLR 3P Neutrik ad angolo - spina volante XLR 3P Neutrik con cavo microfonico 2 x 0,34mm2 / NC3FRX - HPC280 - NC3MXX. Colore disponibile BK.
- *Professional balanced cable with Neutrik right angle XLR 3P female cable mount - Neutrik XLR 3P male cable mount connections and 2 x 0,34 mm2 microphone cable / NC3FRX - HPC280 - NC3MXX. Available colour: BK.*

| CODE | LENGHT |
|------------|------------------|
| ES0285LU1 | 1 mt (3.28 ft) |
| ES0285LU2 | 2 mt (6.56 ft) |
| ES0285LU3 | 3 mt (9.84 ft) |
| ES0285LU5 | 5 mt (16.40 ft) |
| ES0285LU6 | 6 mt (19.69 ft) |
| ES0285LU10 | 10 mt (32.81 ft) |
| ES0285LU15 | 15 mt (49.21 ft) |
| ES0285LU20 | 20 mt (65.62 ft) |



HPC280



ES0290



- Cavo professionale esoterico bilanciato con connessioni presa volante XLR 3P Neutrik - spina volante XLR 3P Neutrik con nuovo cavo microfonico 2 x 0,50 mm2 / NC3FXXB - HPC290BK - NC3MXXB. Colore disponibile BK.
- *Esoteric professional balanced cable with Neutrik XLR 3P female cable mount - Neutrik XLR 3P male cable mount connections and new 2 x 0,50 mm2 microphone cable / NC3FXXB - HPC290BK - NC3MXXB. Available colour: BK.*

| CODE | LENGHT |
|------------|------------------|
| ES0290LU1 | 1 mt (3.28 ft) |
| ES0290LU2 | 2 mt (6.56 ft) |
| ES0290LU3 | 3 mt (9.84 ft) |
| ES0290LU5 | 5 mt (16.40 ft) |
| ES0290LU6 | 6 mt (19.69 ft) |
| ES0290LU10 | 10 mt (32.81 ft) |
| ES0290LU15 | 15 mt (49.21 ft) |
| ES0290LU20 | 20 mt (65.62 ft) |



HPC290



• Custom lengths are available on request

PROFESSIONAL BALANCED CABLES "ESOTERIC" SERIES

PRO CABLES

ES0295 NEW



• Cavo professionale STARQUAD esoterico bilanciato con connessioni presa volante XLR 3P Neutrik - spina volante XLR 3P Neutrik con nuovo cavo microfonico 4 x 0,22 mm² /NC3FXXB - QUAD420 - NC3MXXB. Colore disponibile BK.
 • STARQUAD esoteric professional balanced cable with Neutrik XLR 3P female cable mount - Neutrik XLR 3P male cable mount connections and new 4 x 0,22 mm² microphone cable/NC3FXXB- QUAD420 - NC3MXXB. Available colour: BK.



| CODE | LENGHT |
|------------|------------------|
| ES0295LU5 | 5 mt (16.40 ft) |
| ES0295LU6 | 6 mt (19.69 ft) |
| ES0295LU10 | 10 mt (32.81 ft) |
| ES0295LU15 | 15 mt (49.21 ft) |
| ES0295LU20 | 20 mt (65.62 ft) |

QUAD420



ES0210R



• Avvolgitore professionale PROEL, con cavo microfonico HPC210BK - 2 x 0,22 mm² - assemblato con connettori NEUTRIK femmina volante NC3FXX + maschio volante NC3MXX. Disponibile nelle lunghezze: 50 metri (avvolgitore AV185) - 75 metri - 100 metri (avvolgitore AV190). Colore disponibile BK.
 • PROEL professional cable drum, equipped with HPC280 microphone cable - 2 x 0,34 mm² - assembled with NC3FXX cable mount + NC3MXX cable mount NEUTRIK connectors. Available in: 50 m (AV185 cable drum) - 75 m - 100 m length (AV190 cable drum). Available colour: BK.



| CODE | LENGHT |
|------------|--------------------|
| ES0210R050 | 50 mt (164.04 ft) |
| ES0210R075 | 75 mt (246.06 ft) |
| ES0210R100 | 100 mt (328.08 ft) |

HPC210



ES0280R NEW



• Avvolgitore professionale PROEL, con cavo microfonico HPC280 - 2 x 0,34 mm² - assemblato con connettori NEUTRIK femmina volante NC3FXX + maschio volante NC3MXX. Disponibile nelle lunghezze: 50 metri (avvolgitore AV185) - 75 metri - 100 metri (avvolgitore AV190). Colore disponibile BK.
 • PROEL professional cable drum, equipped with HPC280 microphone cable - 2 x 0,34 mm² - assembled with NC3FXX cable mount + NC3MXX cable mount NEUTRIK connectors. Available in: 50 m (AV185 cable drum) - 75 m - 100 m length (AV190 cable drum). Available colour: BK.



| CODE | LENGHT |
|------------|--------------------|
| ES0280R050 | 50 mt (164.04 ft) |
| ES0280R075 | 75 mt (246.06 ft) |
| ES0280R100 | 100 mt (328.08 ft) |

HPC280



ES0290R NEW



• Avvolgitore professionale PROEL, con cavo microfonico HPC290BK - 2 x 0,50 mm², assemblato con connettori NEUTRIK femmina volante NC3FXXB + maschio volante NC3MXXB. Disponibile nelle lunghezze: 50 metri (avvolgitore AV185) - 75 metri - 100 metri (avvolgitore AV190). Colore disponibile BK.
 • PROEL professional cable drum, equipped with HPC290BK microphone cable - 2 x 0,50 mm² -, assembled with NC3FXXB cable mount + NC3MXXB cable mount NEUTRIK connectors. Available in: 50 m (AV185 cable drum) - 75 m - 100 m length (AV190 cable drum). Available colour: BK.



| CODE | LENGHT |
|------------|--------------------|
| ES0290R050 | 50 mt (164.04 ft) |
| ES0290R075 | 75 mt (246.06 ft) |
| ES0290R100 | 100 mt (328.08 ft) |

HPC290



PROFESSIONAL PASSIVE SPEAKER CABLES "ESOTERIC" SERIES

PRO CABLES

ES0500



• Cavo professionale per diffusori acusti passivi - sez. 2 x 1,5 mm² - con connessioni spina jack Mono Ø 6.3 mm Neutrik / NP2C - HPC610BK - NP2C. Colori disponibili BK.
 • *Esoteric professional assembled cable (2 x 1.5mm²) for passive speakers with Neutrik Ø 6.3 mm Mono jack plug - Neutrik Ø 6.3 mm Mono jack plug connections/NP2C - HPC610BK - NP2C. Available colour: BK.*

| CODE | LENGHT |
|------------|------------------|
| ES0500LU2 | 2 mt (6.56 ft) |
| ES0500LU10 | 10 mt (32.81 ft) |
| ES0500LU15 | 15 mt (49.21 ft) |
| ES0500LU20 | 20 mt (65.62 ft) |



HPC610

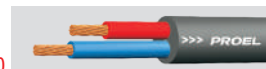

ES0800



• Cavo professionale esoterico per diffusori acustici passivi (sez. 2 x 1,5 mm²) con connessioni Speakon 2P Neutrik/NL2FX - HPC610BK - NL2FX. Colore disponibile: BK.
 • *Esoteric professional assembled cable (2 x 1.5mm²) for passive speakers with Neutrik SPEAKON 2P cable mount female connections/ NL2FX - HPC610BK - NL2FX. Available colour: BK.*

| CODE | LENGHT |
|------------|------------------|
| ES0800LU1 | 1 mt (3.28 ft) |
| ES0800LU2 | 2 mt (6.56 ft) |
| ES0800LU5 | 5 mt (16.40 ft) |
| ES0800LU10 | 10 mt (32.81 ft) |
| ES0800LU15 | 15 mt (49.21 ft) |
| ES0800LU20 | 20 mt (65.62 ft) |



HPC610

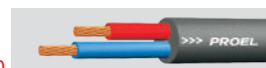

ES01000



• Cavo professionale per diffusori acustici passivi - sez. 2 x 2,5 mm² - con connessioni Speakon 2P Neutrik/NL2FX - HPC620BK - NL2FX. Colore disponibile: BK.
 • *Esoteric professional assembled cable (2 x 2.5mm²) for passive speakers with Neutrik SPEAKON 2P cable mount female connections/NL2FX - HPC620BK - NL2FX. Available colour: BK.*

| CODE | LENGHT |
|-------------|------------------|
| ES01000LU1 | 1 mt (3.28 ft) |
| ES01000LU2 | 2 mt (6.56 ft) |
| ES01000LU5 | 5 mt (16.40 ft) |
| ES01000LU10 | 10 mt (32.81 ft) |
| ES01000LU15 | 15 mt (49.21 ft) |
| ES01000LU20 | 20 mt (65.62 ft) |



HPC620

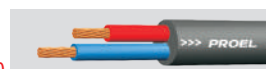

ES01500



• Cavo professionale per diffusori acustici passivi - sez. 2 x 4 mm² - con connessioni Speakon 4P Neutrik/NL4FC - HPC624BK - NL4FC. Colore disponibile BK.
 • *Esoteric professional assembled cable (2 x 4 mm²) for passive speakers with new Neutrik SPEAKON 4P cable mount female connections/NL4FC - HPC624BK - NL4FC. Available colour: BK.*

| CODE | LENGHT |
|-------------|------------------|
| ES01500LU5 | 5 mt (16.40 ft) |
| ES01500LU10 | 10 mt (32.81 ft) |
| ES01500LU15 | 15 mt (49.21 ft) |
| ES01500LU20 | 20 mt (65.62 ft) |



HPC624

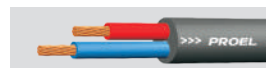

ES02000



• Cavo professionale per diffusori acustici passivi - sez. 4 x 2,5 mm² - con connessioni Speakon 4P Neutrik/NL4FC - HPC640BK - NL4FC. Colore disponibile BK.
 • *Esoteric professional assembled cable (4 x 2.5 mm²) for passive speakers with new Neutrik SPEAKON 4P cable mount female connections/NL4FC - HPC640BK - NL4FC. Available colours: BK.*

| CODE | LENGHT |
|-------------|------------------|
| ES02000LU2 | 2 mt (6.56 ft) |
| ES02000LU10 | 10 mt (32.81 ft) |
| ES02000LU15 | 15 mt (49.21 ft) |
| ES02000LU20 | 20 mt (65.62 ft) |



HPC640



PROFESSIONAL PASSIVE SPEAKER CABLES "ESOTERIC" SERIES

PRO CABLES

ES02500



• Cavo professionale per diffusori acustici passivi - sez. 4 x 4 mm² - con connessioni Speakon 4P Neutrik/NL4FC - HPC644 - NL4FC. Colore disponibile: BK.
 • *Esoteric professional assembled cable (4 x 4 mm²) for passive speakers with new Neutrik SPEAKON 4P cable mount female connections/NL4FC - HPC644 - NL4FC. Available colour: BK.*

| CODE | LENGHT |
|-------------|------------------|
| ES02500LU05 | 0,5 mt (1.64 ft) |
| ES02500LU1 | 1 mt (3.28 ft) |
| ES02500LU2 | 2 mt (6.56 ft) |
| ES02500LU5 | 5 mt (16.40 ft) |
| ES02500LU10 | 10 mt (32.81 ft) |
| ES02500LU15 | 15 mt (49.21 ft) |

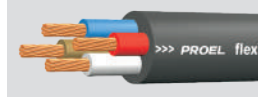

HPC644

ES02700



• Cavo professionale per diffusori acustici passivi - sez. 8 x 2 mm² - con connessioni Speakon 8P Neutrik/NL8FC - HPC685BK - NL8FC. Colore disponibile: BK.
 • *Esoteric professional assembled cable (8 x 2 mm²) for passive speakers with Neutrik SPEAKON 8P cable mount female connections/NL8FC - HPC685BK - NL8FC. Available colour: BK.*

| CODE | LENGHT |
|-------------|------------------|
| ES02700LU10 | 10 mt (32.81 ft) |
| ES02700LU20 | 20 mt (65.62 ft) |

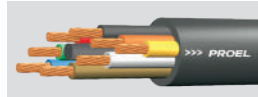

HPC685

PROFESSIONAL DMX CABLES "ESOTERIC" SERIES

CVDMX1N (3 PIN)



• Cavo professionale DMX per segnale DMX512 con connessioni presa volante XLR 3P Neutrik - spina volante XLR 3P Neutrik/NC3FXX - DMXD - NC3MXX. Colore disponibile: BK.
 • *Professional assembled DMX cable for DMX512 signal with Neutrik XLR 3P female cable mount - Neutrik XLR 3P male cable mount connections/NC3FXX - DMXD - NC3MXX. Available colour: BK.*

| CODE | LENGHT |
|------------|------------------|
| CVDMX1N015 | 1.5 mt (4.92 ft) |
| CVDMX1N03 | 3 mt (9.84 ft) |
| CVDMX1N05 | 5 mt (16.40 ft) |
| CVDMX1N10 | 10 mt (32.81 ft) |
| CVDMX1N15 | 15 mt (49.21 ft) |
| CVDMX1N20 | 20 mt (65.62 ft) |



DMXD

CVDMX2N (5 PIN)



• Cavo professionale DMX per segnale DMX512 con connessioni presa volante XLR 5P Neutrik - spina volante XLR 5P Neutrik/NC5FXX - DMXD - NC5MXX. Colore disponibile: BK.
 • *Professional assembled DMX cable for DMX512 signal with Neutrik XLR 5P female cable mount - Neutrik XLR 5P male cable mount connections/NC5FXX - DMXD - NC5MXX. Available colour: BK.*

| CODE | LENGHT |
|------------|------------------|
| CVDMX2N015 | 1.5 mt (4.92 ft) |
| CVDMX2N03 | 3 mt (9.84 ft) |
| CVDMX2N05 | 5 mt (16.40 ft) |
| CVDMX2N10 | 10 mt (32.81 ft) |
| CVDMX2N15 | 15 mt (49.21 ft) |
| CVDMX2N20 | 20 mt (65.62 ft) |



DMXD

PROFESSIONAL PREMADE CABLES "CHALLENGE" SERIES

PRO CABLES

CHALLENGE

• Grazie a quasi due decenni di esperienza nel settore dei cavi Professionali, Proel è orgogliosa di presentare la nuova serie CHALLENGE. Si tratta di una serie professionale assemblata con connettori Yongsheng originali che si compone di cavi per strumento, microfono e per interconnessioni audio in diverse lunghezze e configurazioni. Grazie ai contatti placcati in oro dei connettori JACK, XLR, DIN ed RCA, la serie CHALLENGE assicura un'assoluta qualità e purezza del trasferimento del segnale. Grazie all'altissima qualità nell'utilizzo dei materiali e alla cura maniacale dell'assemblaggio, il mercato ha decretato un forte successo di questa linea.

• Drawing on nearly two decades of experience in the field of Professional cables, Proel is proud to present the new "CHALLENGE" series of assembled cables. A professional series of pre-assembled cables featuring YONGSHENG connectors (manufactured by Ningbo Neutrik Electronics), the CHALLENGE range is composed of instrument, microphone and audio interconnect cables of various lengths and configurations. To assist the signal transfer, the XLR, JACK, RCA and MIDI connectors feature very high quality gold plated contacts. Very high quality yet affordable the CHALLENGE series has already encountered a huge success since its launch.



CONNECTORS
manufactured by
Ningbo Neutrik Electronics

Instrument Cables 83



Unbalanced Cables 83

Balanced Cables 84



MIDI Cables 85



DMX Cables 85



Audio Cables 86



PROFESSIONAL INSTRUMENT CABLES "CHALLENGE" SERIES

PRO CABLES

CHL100



- Cavo professionale per strumenti con connessioni spina jack Mono Ø 6.3 mm Yongsheng - HPC115 - spina jack Mono Ø 6.3 mm Yongsheng Colore disponibile: BK.
- Professional assembled instrument cable with YONGSHENG Ø 6.3 mm Mono jack plug - HPC115 - YONGSHENG Ø 6.3 mm Mono jack plug, black housing and gold plated connections. Available colour: BK.

| CODE | LENGHT |
|------------|------------------|
| CHL100LU1 | 1 mt (3.28 ft) |
| CHL100LU2 | 2 mt (6.56 ft) |
| CHL100LU3 | 3 mt (9.84 ft) |
| CHL100LU5 | 5 mt (16.40 ft) |
| CHL100LU6 | 6 mt (19.69 ft) |
| CHL100LU10 | 10 mt (32.81 ft) |



HPC115



CHL120



- Cavo professionale per strumenti con connessioni spina jack Mono Ø 6.3 mm Yongsheng - HPC115 - spina jack Mono Ø 6.3 mm Yongsheng ad angolo. Colore disponibile BK.
- Professional assembled instrument cable with YONGSHENG Ø 6.3 mm Mono jack plug - HPC115 - YONGSHENG Ø 6.3 mm right angle Mono jack plug, black housing and gold plated connections. Available colour: BK.

| CODE | LENGHT |
|-----------|-----------------|
| CHL120LU1 | 1 mt (3.28 ft) |
| CHL120LU3 | 3 mt (9.84 ft) |
| CHL120LU5 | 5 mt (16.40 ft) |
| CHL120LU6 | 6 mt (19.69 ft) |



HPC115



PROFESSIONAL UNBALANCED CABLES "CHALLENGE" SERIES

CHL200



- Cavo professionale sbilanciato con connessioni spina jack Mono Ø 6.3 mm Yongsheng - HPC225 - presa volante XLR 3P Yongsheng. Colore disponibile: BK.
- Professional assembled unbalanced cable with YONGSHENG Ø 6.3 mm Mono jack plug - HPC225 - YONGSHENG XLR 3P female cable mount, black housing and gold plated connections. Available colour: BK.

| CODE | LENGHT |
|------------|------------------|
| CHL200LU3 | 3 mt (9.84 ft) |
| CHL200LU5 | 5 mt (16.40 ft) |
| CHL200LU6 | 6 mt (19.69 ft) |
| CHL200LU10 | 10 mt (32.81 ft) |



HPC225



CHL220



- Cavo professionale sbilanciato con connessioni spina jack Mono Yongsheng Ø 6.3 mm - HPC225 - spina volante XLR 3P Yongsheng. Colore disponibile: BK.
- Professional assembled unbalanced cable with YONGSHENG Ø 6.3 mm Mono jack plug - HPC225 - YONGSHENG XLR 3P male cable mount, black housing and gold plated connections. Available colour: BK.

| CODE | LENGHT |
|------------|------------------|
| CHL220LU1 | 1 mt (3.28 ft) |
| CHL220LU2 | 2 mt (6.56 ft) |
| CHL220LU3 | 3 mt (9.84 ft) |
| CHL220LU5 | 5 mt (16.40 ft) |
| CHL220LU6 | 6 mt (19.69 ft) |
| CHL220LU10 | 10 mt (32.81 ft) |



HPC225



PROFESSIONAL BALANCED CABLES "CHALLENGE" SERIES

PRO CABLES

CHL140



• Cavo professionale bilanciato con connessioni spina jack Stereo Ø 6.3 mm Yongsheng - HPC225 - spina jack Stereo Ø 6.3 mm Yongsheng. Colore disponibile: BK.

• Professional assembled balanced cable with YONGSHENG Ø 6.3 mm Stereo jack plug - HPC225 - YONGSHENG Ø 6.3 mm Stereo jack plug, black housing and gold plated connections. Available colour: BK.

| CODE | LENGHT |
|------------|------------------|
| CHL140LU1 | 1 mt (3.28 ft) |
| CHL140LU2 | 2 mt (6.56 ft) |
| CHL140LU3 | 3 mt (9.84 ft) |
| CHL140LU5 | 5 mt (16.40 ft) |
| CHL140LU6 | 6 mt (19.69 ft) |
| CHL140LU10 | 10 mt (32.81 ft) |



HPC225



CHL210



• Cavo professionale bilanciato con connessioni spina jack Stereo Ø 6.3 mm Yongsheng - HPC225 - presa volante XLR 3P Yongsheng. Colore disponibile: BK.

• Professional assembled balanced cable with YONGSHENG XLR 3P female cable mount - HPC225 - YONGSHENG Ø 6.3 mm Stereo jack plug, black housing and gold plated connections. Available colour: BK.

| CODE | LENGHT |
|-----------|-----------------|
| CHL210LU1 | 1 mt (3.28 ft) |
| CHL210LU2 | 2 mt (6.56 ft) |
| CHL210LU3 | 3 mt (9.84 ft) |
| CHL210LU5 | 5 mt (16.40 ft) |



HPC225



CHL230



• Cavo professionale bilanciato con connessioni spina jack Stereo Ø 6.3 mm Yongsheng - HPC225 - spina volante XLR 3P Yongsheng. Colore disponibile: BK.

• Professional assembled balanced cable with YONGSHENG XLR 3P male cable mount - HPC225 - YONGSHENG Ø 6.3 mm Stereo jack plug, black housing and gold plated connections. Available colour: BK.

| CODE | LENGHT |
|------------|------------------|
| CHL230LU1 | 1 mt (3.28 ft) |
| CHL230LU2 | 2 mt (6.56 ft) |
| CHL230LU3 | 3 mt (6.56 ft) |
| CHL230LU5 | 5 mt (16.40 ft) |
| CHL230LU10 | 10 mt (32.81 ft) |



HPC225



CHL250



• Cavo professionale bilanciato con connessioni spina volante XLR 3P Yongsheng - HPC225 - presa volante XLR 3P Yongsheng. Colore disponibile: BK.

• Professional assembled balanced cable with YONGSHENG XLR 3P male cable mount - HPC225 - YONGSHENG XLR 3P female cable mount, black housing and gold plated connections. Available colour: BK.

| CODE | LENGHT |
|------------|------------------|
| CHL250LU05 | 0,5 mt (1.64 ft) |
| CHL250LU1 | 1 mt (3.28 ft) |
| CHL250LU2 | 2 mt (6.56 ft) |
| CHL250LU3 | 3 mt (9.84 ft) |
| CHL250LU5 | 5 mt (16.40 ft) |
| CHL250LU6 | 6 mt (19.69 ft) |
| CHL250LU10 | 10 mt (32.81 ft) |
| CHL250LU15 | 15 mt (49.21 ft) |
| CHL250LU20 | 20 mt (65.62 ft) |



HPC225



PROFESSIONAL MINI CABLES "CHALLENGE" SERIES

PRO CABLES

CHL400



- Cavo professionale MIDI con connessioni 5P DIN YONGSHENG. Colore disponibile: BK.
- Professional assembled MIDI cable with YONGSHENG 5P DIN, black housing and gold plated connections. Available colour: BK.



MIDI CABLE

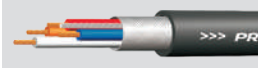

| CODE | LENGHT |
|------------|-------------------|
| CHL400LU15 | 1,5 mt (4.92 ft) |
| CHL400LU3 | 3,0 mt (9.84 ft) |
| CHL400LU5 | 5,0 mt (16.40 ft) |

PROFESSIONAL DMX CABLE "CHALLENGE" SERIES

CHL500 (3 PIN)



- Cavo professionale DMX per segnale DMX512 con connessioni presa volante XLR 3P YONGSHENG - spina volante XLR 3P YONGSHENG. Colore disponibile: BK.
- Professional assembled DMX cable for DMX512 signal with YONGSHENG XLR 3P female cable mount - YONGSHENG XLR 3P male cable mount connections. Available colour: BK.



DMX



| CODE | LENGHT |
|------------|------------------|
| CHL500LU2 | 2 mt (6.56 ft) |
| CHL500LU3 | 3 mt (9.84 ft) |
| CHL500LU5 | 5 mt (16.40 ft) |
| CHL500LU10 | 10 mt (32.81 ft) |

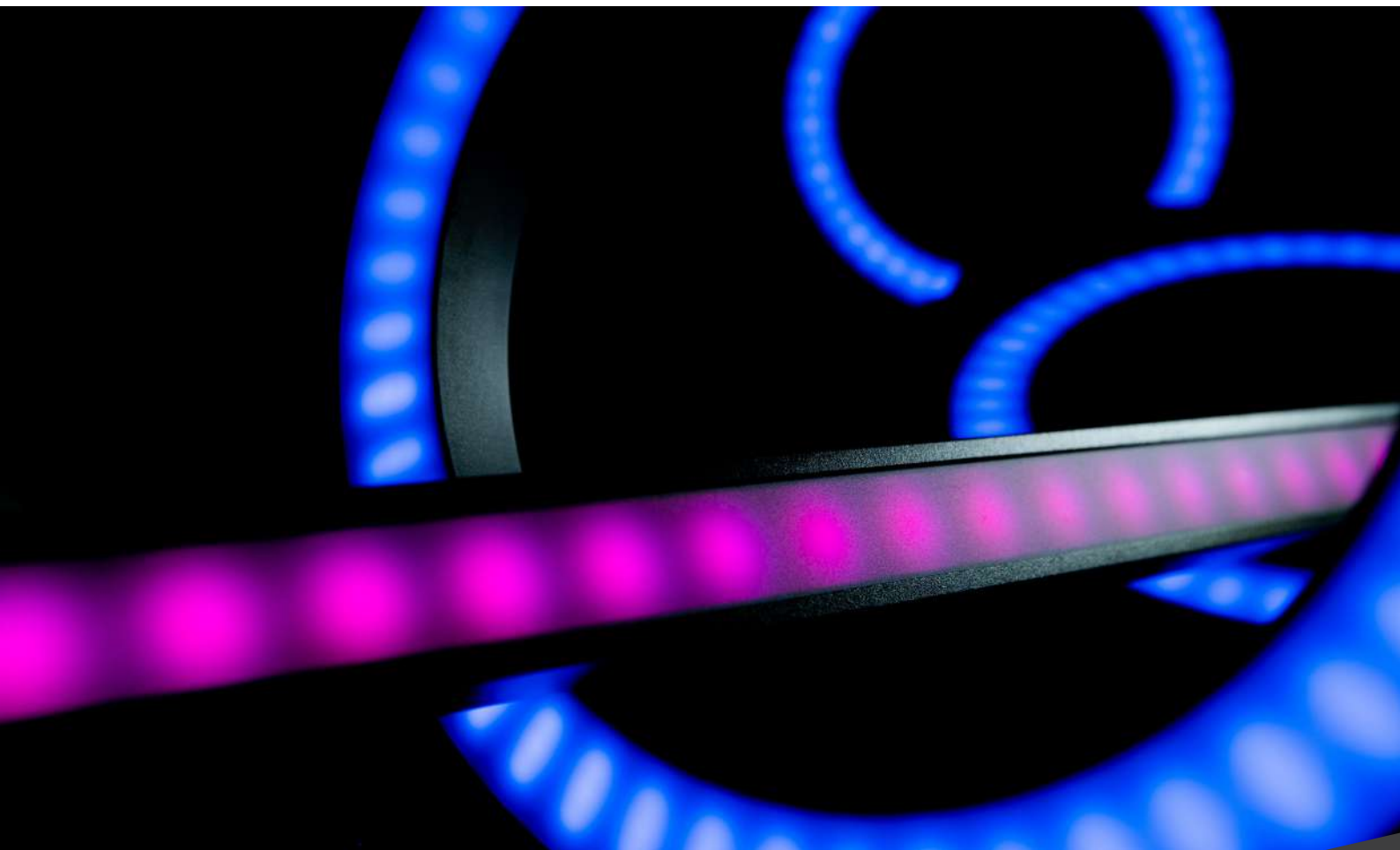

PROFESSIONAL AUDIO INTERCONNECTIONS CABLES "CHALLENGE" SERIES

PRO CABLES

CHLP115



• Cavo audio professionale con connessioni spina jack Mono Ø 6.3 mm ad angolo Yongsheng - spina jack Mono Ø 6.3 mm ad angolo Yongsheng. Colore disponibile: BK.

• Professional assembled instrument cable with YONGSHENG Ø 6.3 mm right angle Mono jack plug - YONGSHENG Ø 6.3 mm right angle Mono jack plug, black housing and gold plated connections. Available colour: BK.

| CODE | LENGHT |
|--------------|-------------------|
| CHLP115LU015 | 0.15 mt (0.49 ft) |
| CHLP115LU03 | 0.30 mt (0.98 ft) |
| CHLP115LU06 | 0.60 mt (1.97 ft) |



CHLP170



• Cavo audio professionale "Y" con connessioni spina jack Stereo Yongsheng Ø 3.5 mm - 2 x spina jack Mono Ø 6.3 mm Yongsheng. Colore disponibile: BK.

• Professional assembled audio "Y" cable with YONGSHENG Ø 3.5 mm Stereo jack plug - 2 x YONGSHENG Ø 6.3 mm Mono jack plug, black housing and gold plated connections. Available colour: BK.

| CODE | LENGHT |
|-------------|-------------------|
| CHLP170LU15 | 1,5 mt (4.92 ft) |
| CHLP170LU3 | 3,0 mt (9.84 ft) |
| CHLP170LU5 | 5,0 mt (16.40 ft) |



CHLP170XL



• Cavo audio professionale "Y" con connessioni spina jack Stereo Yongsheng Ø 3.5 mm (**cavo da 16 cm**) - 2 x spina jack Mono Ø 6.3 mm Yongsheng. Colore disponibile: BK.

• Professional assembled audio "Y" cable with YONGSHENG Ø 3.5 mm Stereo jack plug (**16 cm cable**) - 2 x YONGSHENG Ø 6.3 mm Mono jack plug, black housing and gold plated connections. Available colour: BK.

| CODE | LENGHT |
|---------------|-------------------|
| CHLP170LU15XL | 1,5 mt (4.92 ft) |
| CHLP170LU3XL | 3,0 mt (9.84 ft) |
| CHLP170LU5XL | 5,0 mt (16.40 ft) |



CHLP175



• Cavo audio professionale bilanciato con connessioni spina jack Stereo Ø 3.5 mm Yongsheng - spina jack Stereo Ø 3.5 mm Yongsheng. Colore disponibile: BK.

• Professional assembled balanced cable with YONGSHENG Ø 3.5 mm Stereo jack plug - YONGSHENG Ø 3.5 mm Stereo jack plug, black housing and gold plated connections. Available colour: BK.

| CODE | LENGHT |
|-------------|------------------|
| CHLP175LU15 | 1.5 mt (4.92 ft) |
| CHLP175LU3 | 3.0 mt (9.84 ft) |



CHLP180



• Cavo audio professionale "EXTENSION" con connessioni spina jack Stereo Ø 3.5 mm Yongsheng - presa jack Stereo Ø 3.5 mm Yongsheng. Colore disponibile: BK.

• Professional assembled "EXTENSION" cable with YONGSHENG Ø 3.5 mm Stereo jack plug - YONGSHENG Ø 3.5 mm Stereo jack socket, black housing and gold plated connections. Available colour: BK.

| CODE | LENGHT |
|-------------|-------------------|
| CHLP180LU3 | 3,0 mt (9.84 ft) |
| CHLP180LU5 | 5,0 mt (16.40 ft) |
| CHLP180LU10 | 10 mt (32.81 ft) |



PROFESSIONAL AUDIO INTERCONNECTIONS CABLES "CHALLENGE" SERIES

PRO CABLES

CHLP185



• Cavo audio professionale bilanciato con connessioni jack Stereo Ø 3.5 mm Yongsheng - jack Stereo Ø 6.3 mm Yongsheng. Colore disponibile: BK.
 • Professional assembled balanced cable with YONGSHENG Ø 3.5 mm Stereo jack plug - YONGSHENG Ø 6.3 mm Stereo jack plug, black housing and gold plated connections. Available colour: BK.

| CODE | LENGHT |
|-------------|------------------|
| CHLP185LU15 | 1,5 mt (4.92 ft) |
| CHLP185LU3 | 3,0 mt (9.84 ft) |



CHLP190



• Cavo audio professionale "EXTENSION" con connessioni jack Stereo Ø 6.3 mm Yongsheng - presa jack Stereo Ø 6.3 mm Yongsheng. Colore disponibile: BK.
 • Professional assembled "EXTENSION" cable with YONGSHENG Ø 6.3 mm Stereo jack plug - YONGSHENG Ø 6.3 mm Stereo jack socket, black housing and gold plated connections. Available colour: BK.

| CODE | LENGHT |
|-------------|-------------------|
| CHLP190LU3 | 3,0 mt (9.84 ft) |
| CHLP190LU5 | 5,0 mt (16.40 ft) |
| CHLP190LU10 | 10 mt (32.81 ft) |



CHLP210



• Cavo audio professionale "INSERT" con connessioni jack Stereo Ø 6.3 mm Yongsheng - 2 x spina jack Mono Ø 6.3 mm Yongsheng. Colore disponibile: BK.
 • Professional assembled "INSERT" cable with YONGSHENG Ø 6.3 mm Stereo jack plug - 2 x YONGSHENG Ø 6.3 mm Mono jack plug, black housing and gold plated connections. Available colour: BK.

| CODE | LENGHT |
|-------------|-------------------|
| CHLP210LU15 | 1,5 mt (4.92 ft) |
| CHLP210LU3 | 3,0 mt (9.84 ft) |
| CHLP210LU5 | 5,0 mt (16.40 ft) |



CHLP215



• Cavo audio professionale "Y" con connessioni jack Stereo Ø 3.5 mm Yongsheng - 2 x spina RCA Yongsheng. Colore disponibile: BK.
 • Professional assembled audio "Y" cable with YONGSHENG Ø 3.5 mm Stereo jack plug - 2 x YONGSHENG RCA plug, black housing and gold plated connections. Available colour: BK.

| CODE | LENGHT |
|-------------|-------------------|
| CHLP215LU15 | 1,5 mt (4.92 ft) |
| CHLP215LU3 | 3,0 mt (9.84 ft) |
| CHLP215LU5 | 5,0 mt (16.40 ft) |



CHLP215XL



• Cavo audio professionale "Y" con connessioni jack Stereo Ø 3.5 mm Yongsheng (cavo da 16 cm) - 2 x spina RCA Yongsheng. Colore disponibile: BK.
 • Professional assembled audio "Y" cable with YONGSHENG Ø 3.5 mm Stereo jack plug (16 cm cable) - 2 x YONGSHENG RCA plug, black housing and gold plated connections. Available colour: BK.

| CODE | LENGHT |
|---------------|-------------------|
| CHLP215LU15XL | 1,5 mt (4.92 ft) |
| CHLP215LU3XL | 3,0 mt (9.84 ft) |
| CHLP215LU5XL | 5,0 mt (16.40 ft) |
| CHLP215LU10XL | 10 mt (32.81 ft) |



PROFESSIONAL AUDIO INTERCONNECTIONS CABLES "CHALLENGE" SERIES

PRO CABLES

CHLP220



• Cavo audio professionale "ADAPTER" con connessioni spina jack Mono Ø 6.3 mm Yongsheng - spina RCA Yongsheng. Colore disponibile: BK.

• Professional assembled "ADAPTER" cable with YONGSHENG Ø 6.3 mm Mono jack plug - YONGSHENG RCA plug, black housing and gold plated connections. Available colour: BK.

| CODE | LENGHT |
|-------------|------------------|
| CHLP220LU15 | 1,5 mt (4.92 ft) |
| CHLP220LU3 | 3,0 mt (9.84 ft) |



CHLP250



• Cavo audio professionale "STEREO" con connessioni 2 x spina RCA Yongsheng - 2 x spina RCA Yongsheng. Colore disponibile: BK.

• Professional assembled "STEREO" cable with 2 x YONGSHENG RCA plug - 2 x YONGSHENG RCA plug, black housing and gold plated connections. Available colour: BK.

| CODE | LENGHT |
|-------------|------------------|
| CHLP250LU15 | 1,5 mt (4.92 ft) |
| CHLP250LU3 | 3,0 mt (9.84 ft) |



CHLP260



• Cavo audio professionale "ADAPTER" con connessioni spina RCA Yongsheng - spina volante XLR 3P Yongsheng. Colore disponibile: BK.

• Professional assembled "ADAPTER" cable with YONGSHENG RCA cable mount plug - YONGSHENG XLR 3P male cable mount, black housing and gold plated connections. Available colour: BK.

| CODE | LENGHT |
|-------------|-------------------|
| CHLP260LU15 | 1,5 mt (4.92 ft) |
| CHLP260LU3 | 3,0 mt (9.84 ft) |
| CHLP260LU5 | 5,0 mt (16.40 ft) |



CHLP270



• Cavo audio professionale "ADAPTER" con connessioni spina RCA Yongsheng - presa volante XLR 3P Yongsheng. Colore disponibile: BK.

• Professional assembled "ADAPTER" cable with YONGSHENG RCA cable mount plug - YONGSHENG XLR 3P female cable mount, black housing and gold plated connections. Available colour: BK.

| CODE | LENGHT |
|-------------|------------------|
| CHLP270LU15 | 1,5 mt (4.92 ft) |
| CHLP270LU3 | 3,0 mt (9.84 ft) |



CHLP280



• Cavo audio professionale bilanciato con connessioni jack Stereo Ø 3.5 mm Yongsheng - presa volante XLR 3P Yongsheng. Colore disponibile: BK.

• Professional assembled balanced cable with Yongsheng Ø 3.5 mm Stereo jack plug - Yongsheng 3P female cable mount XLR. Available colour: BK.

| CODE | LENGHT |
|-------------|------------------|
| CHLP280LU15 | 1,5 mt (4.92 ft) |
| CHLP280LU3 | 3,0 mt (9.84 ft) |



PROFESSIONAL AUDIO INTERCONNECTIONS CABLES "CHALLENGE" SERIES

PRO CABLES

CHLP290 NEW



• Cavo audio professionale bilanciato con connessioni jack Stereo Ø 3.5 mm Yongsheng - spina volante XLR 3P Yongsheng. Colore disponibile: BK.

• Professional assembled balanced cable with Yongsheng Ø 3.5 mm Stereo jack plug - Yongsheng 3P male cable mount XLR. Available colour: BK.

| CODE | LENGHT |
|-------------|-------------------|
| CHLP290LU15 | 1,5 mt (4.92 ft) |
| CHLP290LU3 | 3,0 mt (9.84 ft) |
| CHLP290LU5 | 5,0 mt (16.40 ft) |
| CHLP290LU10 | 10 mt (32.81 ft) |



CHLP300



• Cavo audio professionale "Y" con connessioni spina jack Stereo Ø 6.3 mm Yongsheng - 2 x spina RCA Yongsheng. Colore disponibile: BK.

• Professional assembled "Y" cable with YONGSHENG Ø 6.3 mm Stereo jack plug - 2 x YONGSHENG RCA plug, black housing and gold plated connections. Available colour: BK.

| CODE | LENGHT |
|------------|------------------|
| CHLP300LU3 | 3,0 mt (9.84 ft) |



CHLP310



• Cavo audio professionale "STEREO" con connessioni 2 x jack spina Mono Ø 6.3 mm Yongsheng - 2 x spina RCA Yongsheng. Colore disponibile: BK.

• Professional assembled "STEREO" cable with YONGSHENG 2 x Ø 6.3 mm Mono jack plug - 2 x YONGSHENG RCA plug, black housing and gold plated connections. Available colour: BK.

| CODE | LENGHT |
|-------------|-------------------|
| CHLP310LU15 | 1,5 mt (4.92 ft) |
| CHLP310LU3 | 3,0 mt (9.84 ft) |
| CHLP310LU5 | 5,0 mt (16.40 ft) |



CHLP315



• Cavo audio professionale "STEREO" con connessioni Yongsheng 2 x jack spina Mono Ø 6.3 mm > 2 x jack spina Mono Ø 6.3 mm. Colore disponibile: BK.

• Professional assembled "STEREO" cable with YONGSHENG 2 x Ø 6.3 mm Mono jack plug - 2 x Ø 6.3 mm Mono jack plug YONGSHENG, black housing and gold plated connections. Available colour: BK.

| CODE | LENGHT |
|-------------|-------------------|
| CHLP315LU15 | 1,5 mt (4.92 ft) |
| CHLP315LU3 | 3,0 mt (9.84 ft) |
| CHLP315LU5 | 5,0 mt (16.40 ft) |



CHLP320



• Cavo audio professionale "Y" con connessioni spina jack Stereo Ø 3.5 mm YONGSHENG - 2 x spina volante XLR 3P YONGSHENG. Colore disponibile: BK.

• Professional assembled "Y" cable with YONGSHENG Ø 3.5 mm Stereo jack plug - 2 x YONGSHENG 3P XLR male plug, black housing and gold plated connections. Available colour: BK.

| CODE | LENGHT |
|-------------|-------------------|
| CHLP320LU03 | 0.30 mt (0.98 ft) |
| CHLP320LU15 | 1,5 mt (4.92 ft) |
| CHLP320LU3 | 3,0 mt (9.84 ft) |



PROFESSIONAL AUDIO INTERCONNECTIONS CABLES "CHALLENGE" SERIES

PRO CABLES

CHLP325



• Cavo audio professionale "Y" con connessioni spina jack Stereo Ø 6.3 mm YONGSHENG - 2 x spina volante XLR 3P YONGSHENG. Colore disponibile: BK.

• Professional assembled "Y" cable with YONGSHENG Ø 6.3 mm Stereo jack plug - 2 x YONGSHENG 3P XLR male plug, black housing and gold plated connections. Available colour: BK.

| CODE | LENGHT |
|-------------|-------------------|
| CHLP325LU03 | 0,30 mt (0.98 ft) |
| CHLP325LU15 | 1,5 mt (4.92 ft) |
| CHLP325LU3 | 3,0 mt (9.84 ft) |



CHLP330



• Cavo audio professionale "STEREO" con connessioni 2 X spina RCA YONGSHENG - 2 x spina volante XLR 3P YONGSHENG. Colore disponibile: BK.

• Professional assembled "STEREO" cable with 2 x YONGSHENG RCA plug - 2 x YONGSHENG 3P XLR male plug, black housing and gold plated connections. Available colour: BK.

| CODE | LENGHT |
|-------------|------------------|
| CHLP330LU15 | 1,5 mt (4.92 ft) |
| CHLP330LU3 | 3,0 mt (9.84 ft) |



CHLP335



• Cavo audio professionale adattatore per cambio genere con connessioni - 2 x spina volante XLR 3P YONGSHENG. Colore disponibile: BK.

• Professional gender change assembled cable with 2 x YONGSHENG 3P XLR male plug, black housing and gold plated connections. Available colour: BK.

| CODE | LENGHT |
|--------------|-------------------|
| CHLP335LU015 | 0,15 mt (0.49 ft) |



CHLP340



• Cavo audio professionale adattatore per cambio genere con connessioni - 2 x presa volante XLR 3P YONGSHENG. Colore disponibile: BK.

• Professional gender change assembled cable with 2 x YONGSHENG 3P XLR female plug, black housing and gold plated connections. Available colour: BK.

| CODE | LENGHT |
|--------------|-------------------|
| CHLP340LU015 | 0,15 mt (0.38 ft) |



PROFESSIONAL STUDIO LOOMS "CHALLENGE" SERIES

PRO CABLES

CHLP430



• Cavo professionale multipolare analogico bilanciato per studi di registrazione con connessioni in metallo YONGSHENG / 8 x presa volante XLR 3P - 8 x spina volante XLR 3P, di colore nero e contatti dorati. Lunghezza 4 metri. Colore disponibile: BK.

• Professional assembled analogic "Studio Loom" with 8 x YONGSHENG XLR 3P male cable mount - PROEL multicore cable - 8 x XLR 3P female cable mount, black housing and gold plated connections. 4 mt length. Available colour: BK.



| CODE | LENGHT |
|------------|-------------------|
| CHLP430LU4 | 4.0 mt (13.12 ft) |

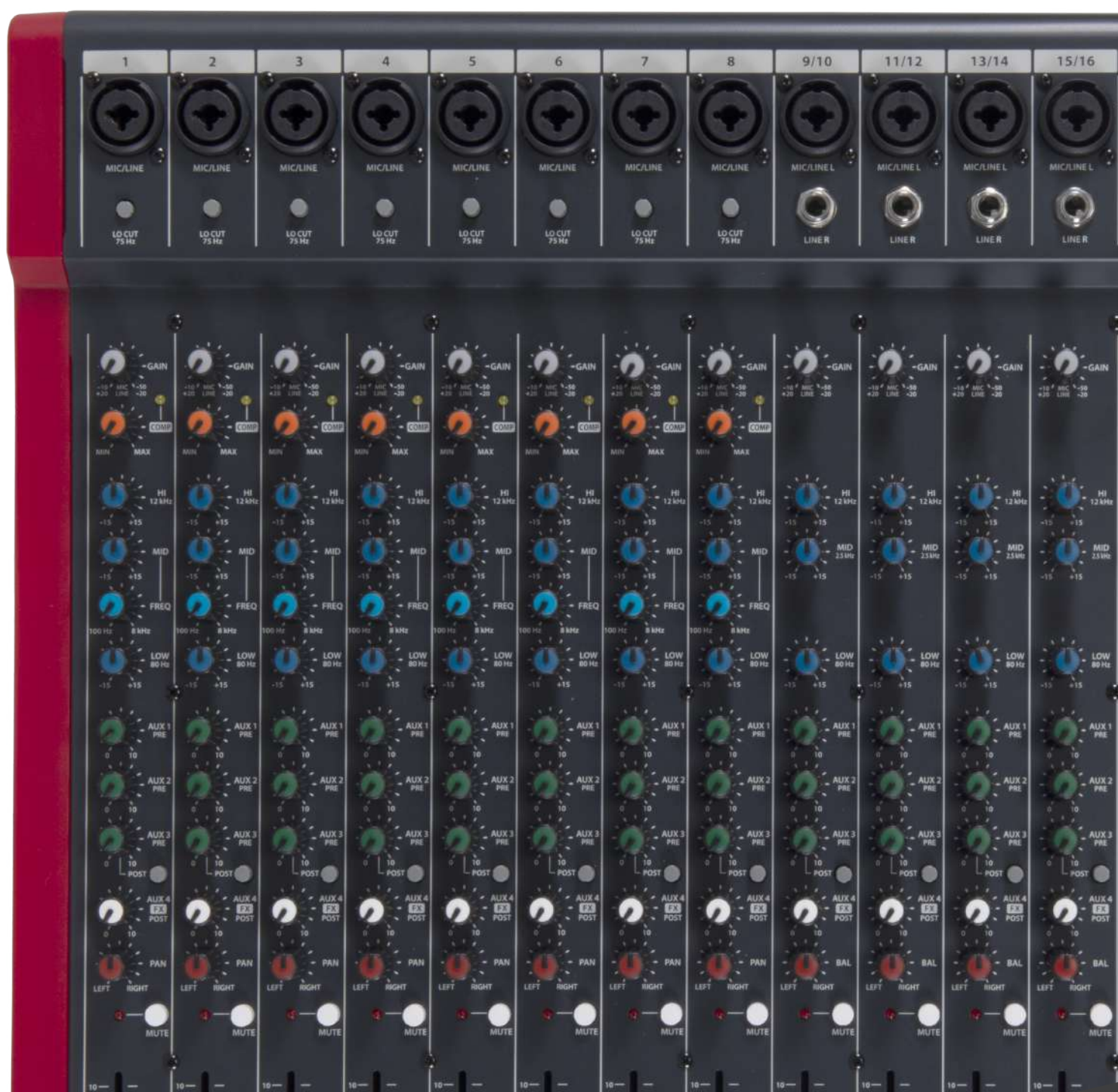

PROFESSIONAL PREMADE CABLES "BRAVE" SERIES

PRO CABLES

BRAVE

• La serie di cavi assemblati professionali BRAVE è ancora una volta il risultato della ricerca PROEL nel seguire le evoluzioni del mercato. La serie BRAVE si contraddistingue per i materiali utilizzati per la realizzazione dei prodotti, a partire dal rame O.F.C. di altissima qualità, per poi proseguire con gli speciali compound di PVC utilizzati per la realizzazione delle guaine e lo speciale cotone per la copertura, che conferisce ai prodotti un aspetto vintage. Per ultima, ma non meno importante, la caratteristica della dimensione delle guaine, con un diametro esterno di oltre 7 mm. Per l'assemblaggio sono stati utilizzati connettori PROEL di alta qualità che nelle versioni dei cavi per chitarra, presentano una copertura a mezzo di guaina termorestringente. Le varianti incluse in questa serie di cavi sono quelle più comunemente utilizzate per le connessioni per chitarra e per microfono, prevedendo la disponibilità di diverse colorazioni e finiture.

• BRAVE series professional premade cables is once again the result of Proel research in following market evolutions. This series is identified for materials used for products realisation, starting from the highest quality of O.F.C copper going on to the special PVC compounds used for jacket and the special cotton roofing that confers a vintage look to the products. Last but not less important the distinctive feature of jackets with an external diameter over 7 mm. For the assembly high quality Proel connectors have been used that in guitar cables present a roofing through an heat-shrink jacket. The variations included in this cable series are the ones more commonly used for guitar and microphone connections and allow the availability of different colours and finishing.

Instrument Cables 93



Balanced Cables 95



PROFESSIONAL INSTRUMENT CABLES "BRAVE" SERIES

PRO CABLES

BRV100 BK



- Cavo professionale per strumenti con connessioni spina jack Mono Ø 6.3 mm - HPC118 - spina jack Mono Ø 6.3 mm. Guaina in PVC flessibile di colore Nero - Ø 7 mm.
- Professional assembled instrument cable with Ø 6,3 mm mono jack plug - HPC118 - Ø 6,3 mm mono jack plug connections. Black flexible PVC jacket - Ø 7 mm.

| DESCRIPTION | LENGHT |
|--------------|------------------|
| BRV100LU3BK | 3 mt (9.84 ft) |
| BRV100LU5BK | 5 mt (16.40 ft) |
| BRV100LU6BK | 6 mt (19.69 ft) |
| BRV100LU10BK | 10 mt (32.81 ft) |



BRV120 BK



- Cavo professionale per strumenti con connessioni spina jack Mono Ø 6.3 mm - HPC118 - spina jack Mono Ø 6.3 mm ad angolo. Guaina in PVC flessibile di colore Nero - Ø 7 mm.
- Professional assembled instrument cable with Ø 6,3 mm mono jack plug - HPC118 - Ø 6,3 mm right angle mono jack plug connections. Black flexible PVC jacket - Ø 7 mm.

| DESCRIPTION | LENGHT |
|-------------|-----------------|
| BRV120LU3BK | 3 mt (9.84 ft) |
| BRV120LU5BK | 5 mt (16.40 ft) |
| BRV120LU6BK | 6 mt (19.69 ft) |



BRV100 BY



- Cavo professionale per strumenti con connessioni spina jack Mono Ø 6.3 mm - HPC1105 - spina jack Mono Ø 6.3 mm. Guaina in PVC flessibile con rivestimento in cotone Marrone / Oro - Ø 7 mm.
- Professional assembled instrument cable with Ø 6,3 mm mono jack plug - HPC1105 - Ø 6,3 mm mono jack plug connections. Cotton covered flexible PVC jacket Brown/Gold color finishing - Ø 7 mm.

| DESCRIPTION | LENGHT |
|-------------|-----------------|
| BRV100LU3BY | 3 mt (9.84 ft) |
| BRV100LU5BY | 5 mt (16.40 ft) |
| BRV100LU6BY | 6 mt (19.69 ft) |

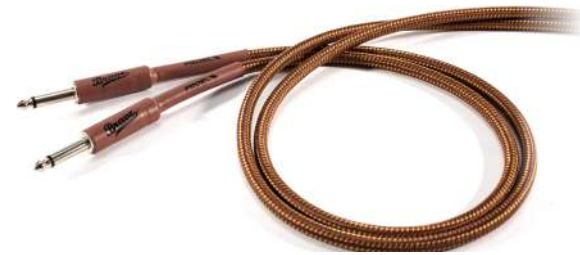

BRV120 BY



- Cavo professionale per strumenti con connessioni spina jack Mono Ø 6.3 mm - HPC1105 - spina jack Mono Ø 6.3 mm ad angolo. Guaina in PVC flessibile con rivestimento in cotone Marrone / Oro - Ø 7 mm.
- Professional assembled instrument cable with Ø 6,3 mm mono jack plug - HPC1105 - Ø 6,3 mm right angle mono jack plug connections. Cotton covered flexible PVC jacket Brown/Gold color finishing - Ø 7 mm.

| DESCRIPTION | LENGHT |
|-------------|-----------------|
| BRV120LU3BY | 3 mt (9.84 ft) |
| BRV120LU5BY | 5 mt (16.40 ft) |
| BRV120LU6BY | 6 mt (19.69 ft) |



BRV100 BW



- Cavo professionale per strumenti con connessioni spina jack Mono Ø 6.3 mm - HPC1105 - spina jack Mono Ø 6.3 mm. Guaina in PVC flessibile con rivestimento in cotone Nero / Bianco - Ø 7 mm.
- Professional assembled instrument cable with Ø 6,3 mm mono jack plug - HPC1105 - Ø 6,3 mm mono jack plug connections. Cotton covered flexible PVC jacket Black / White color finishing - Ø 7 mm.

| DESCRIPTION | LENGHT |
|-------------|-----------------|
| BRV100LU3BW | 3 mt (9.84 ft) |
| BRV100LU5BW | 5 mt (16.40 ft) |
| BRV100LU6BW | 6 mt (19.69 ft) |



BRV120 BW



- Cavo professionale per strumenti con connessioni spina jack Mono Ø 6.3 mm - HPC1105 - spina jack Mono Ø 6.3 mm ad angolo. Guaina in PVC flessibile con rivestimento in cotone Nero / Bianco - Ø 7 mm.
- Professional assembled instrument cable with Ø 6,3 mm mono jack plug - HPC1105 - Ø 6,3 mm right angle mono jack plug connections. Cotton covered flexible PVC jacket Black / White color finishing - Ø 7 mm.

| DESCRIPTION | LENGHT |
|-------------|-----------------|
| BRV120LU3BW | 3 mt (9.84 ft) |
| BRV120LU5BW | 5 mt (16.40 ft) |
| BRV120LU6BW | 6 mt (19.69 ft) |



PROFESSIONAL INSTRUMENT CABLES "BRAVE" SERIES

PRO CABLES

BRV100 TB



- Cavo professionale per strumenti con connessioni spina jack Mono Ø 6.3 mm – HPC125 - spina jack Mono Ø 6.3 mm. Guaina in PVC flessibile di colore Blu trasparente - Ø 7 mm.
- Professional assembled instrument cable with Ø 6,3 mm mono jack plug – HPC125 - Ø 6,3 mm mono jack plug connections. Transparent Blue flexible PVC jacket – Ø 7 mm.

| DESCRIPTION | LENGHT |
|-------------|-----------------|
| BRV100LU3TB | 3 mt (9.84 ft) |
| BRV100LU5TB | 5 mt (16.40 ft) |
| BRV100LU6TB | 6 mt (19.69 ft) |



BRV120 TB



- Cavo professionale per strumenti con connessioni spina jack Mono Ø 6.3 mm – HPC125 - spina jack Mono Ø 6.3 mm ad angolo. Guaina in PVC flessibile di colore Blu trasparente - Ø 7 mm.
- Professional assembled instrument cable with Ø 6,3 mm mono jack plug – HPC125 - Ø 6,3 mm right angle mono jack plug connections. Transparent Blue flexible PVC jacket – Ø 7 mm.

| DESCRIPTION | LENGHT |
|-------------|-----------------|
| BRV120LU3TB | 3 mt (9.84 ft) |
| BRV120LU5TB | 5 mt (16.40 ft) |
| BRV120LU6TB | 6 mt (19.69 ft) |



BRV100 TR



- Cavo professionale per strumenti con connessioni spina jack Mono Ø 6.3 mm – HPC125 - spina jack Mono Ø 6.3 mm. Guaina in PVC flessibile di colore Rosso trasparente - Ø 7 mm.
- Professional assembled instrument cable with Ø 6,3 mm mono jack plug – HPC125 - Ø 6,3 mm mono jack plug connections. Transparent Red flexible PVC jacket – Ø 7 mm.

| DESCRIPTION | LENGHT |
|-------------|-----------------|
| BRV100LU3TR | 3 mt (9.84 ft) |
| BRV100LU5TR | 5 mt (16.40 ft) |
| BRV100LU6TR | 6 mt (19.69 ft) |



BRV120 TR



- Cavo professionale per strumenti con connessioni spina jack Mono Ø 6.3 mm – HPC125 - spina jack Mono Ø 6.3 mm ad angolo. Guaina in PVC flessibile di colore Rosso trasparente - Ø 7 mm.
- Professional assembled instrument cable with Ø 6,3 mm mono jack plug – HPC125 - Ø 6,3 mm right angle mono jack plug connections. Transparent Red flexible PVC jacket – Ø 7 mm.

| DESCRIPTION | LENGHT |
|-------------|-----------------|
| BRV120LU3TR | 3 mt (9.84 ft) |
| BRV120LU5TR | 5 mt (16.40 ft) |
| BRV120LU6TR | 6 mt (19.69 ft) |



BRV130 BY



- Set di due cavi professionali per strumenti con connessioni spina jack Mono Ø 6.3 mm ad angolo - HPC1105 - spina jack Mono Ø 6.3 mm ad angolo. Guaina in PVC flessibile con rivestimento in cotone Marrone / Oro - Ø 7 mm.
- Pair of professional assembled instrument cables with Ø 6,3 mm right angle mono jack plug - HPC1105 - Ø 6,3 mm right angle mono jack plug connections. Cotton covered flexible PVC jacket Brown / Gold color finishing - Ø 7 mm.

| DESCRIPTION | LENGHT |
|---------------|-------------------|
| BRV130LU015BY | 0,15 mt (0.49 ft) |



BRV130 BW



- Set di due cavi professionali per strumenti con connessioni spina jack Mono Ø 6.3 mm ad angolo - HPC1105 - spina jack Mono Ø 6.3 mm ad angolo. Guaina in PVC flessibile con rivestimento in cotone Nero / Bianco - Ø 7 mm.
- Pair of professional assembled instrument cables with Ø 6,3 mm right angle mono jack plug - HPC1105 - Ø 6,3 mm right angle mono jack plug connections. Cotton covered flexible PVC jacket Black / White color finishing - Ø 7 mm.

| DESCRIPTION | LENGHT |
|---------------|-------------------|
| BRV130LU015BW | 0,15 mt (0.49 ft) |



PROFESSIONAL BALANCED CABLES "BRAVE" SERIES

PRO CABLES

BRV250 BK



• Cavo professionale bilanciato per microfono con connessioni spina volante XLR 3 poli – HPC228 – presa volante XLR 3 poli. Guaina in PVC flessibile di colore Nero – Ø 7 mm.

• Professional assembled balanced microphone cable with 3P XLR female – HPC228 – 3P XLR male connections. Black flexible PVC jacket – Ø 7 mm.

| DESCRIPTION | LENGHT |
|--------------|------------------|
| BRV250LU5BK | 5 mt (16.40 ft) |
| BRV250LU6BK | 6 mt (19.69 ft) |
| BRV250LU10BK | 10 mt (32.81 ft) |



BRV250 BW



• Cavo professionale bilanciato per microfono con connessioni spina volante XLR 3 poli – HPC228 – presa volante XLR 3 poli. Guaina in PVC flessibile con rivestimento in cotone Nero / Bianco – Ø 7 mm.

• Professional assembled balanced microphone cable with 3P XLR female – HPC228 – 3P XLR male connections. Cotton covered flexible PVC jacket Black / White color finishing – Ø 7 mm.

| DESCRIPTION | LENGHT |
|--------------|------------------|
| BRV250LU5BW | 5 mt (16.40 ft) |
| BRV250LU6BW | 6 mt (19.69 ft) |
| BRV250LU10BW | 10 mt (32.81 ft) |



PROFESSIONAL PREMADE CABLES "STAGE INNOVATION" SERIES

PRO CABLES

• La scelta dei cavi della serie "STAGE Innovation" è un passo importante. Nel mercato odierno ancora pochi prestano attenzione alla qualità dei cavi assemblati, con la conseguenza di dover poi verificare, durante l'esecuzione, il loro difettoso funzionamento e i possibili ulteriori problemi che possono generare a tutte le strumentazioni collegate. In PROEL siamo consapevoli dell'importanza dell'affidabilità e delle qualità di un cavo, ed è per questo che vi offriamo un prodotto che vi renderà pienamente soddisfatti. La serie "STAGE Innovation" di cavi assemblati PROEL è composta dai migliori connettori professionali di nostra produzione. Il risultato finale è un cavo professionale che garantisce lunga durata, sulla cui efficienza e qualità potrete contare per molti anni.

• *The STAGE INNOVATION series of cables represents an important step in the market of pre-assembled leads for the professional user who is looking for the perfect match of high quality at an affordable price. At PROEL we recognise just how important it is to have a cable that is both reliable and long lasting. Made from high quality materials and manufactured to the highest criteria, STAGE INNOVATION can meet these requirements. Featuring the best PROEL metal connectors, STAGE INNOVATION stands alone for its highly professional, ergonomic characteristics and a modern and extremely aggressive look. The result? A high quality professional cable that you can rely on for many years.*

STAGE INNOVATION

Instrument Cables 97



Unbalanced Cables 98

Balanced Cables 98



Passive Speaker Cables 99



DMX Cables 100



Studio Looms 112



PROFESSIONAL INSTRUMENT CABLES "STAGE INNOVATION" SERIES

PRO CABLES

STAGE100



- Cavo professionale per strumenti con connessioni spina jack Mono Ø 6.3 mm PROEL/S290BK - HPC110BK - S290BK. Colore disponibile: BK.
- Professional assembled instrument cable with PROEL Ø 6.3 mm rubber covered Mono jack plug connections/S290BK - HPC110BK - S290BK. Available colour: BK.

| DESCRIPTION | LENGHT |
|--------------|------------------|
| STAGE100LU05 | 0,5 mt (1.64 ft) |
| STAGE100LU1 | 1 mt (3.28 ft) |
| STAGE100LU2 | 2 mt (6.56 ft) |
| STAGE100LU3 | 3 mt (9.84 ft) |
| STAGE100 | 5 mt (16.40 ft) |
| STAGE100LU6 | 6 mt (19.69 ft) |
| STAGE110 | 10 mt (32.81 ft) |
| STAGE100LU15 | 15 mt (49.21 ft) |
| STAGE100LU20 | 20 mt (65.62 ft) |



HPC110



STAGE180



- Cavo professionale per strumenti con connessioni spina jack Mono Ø 6.3 mm PROEL/S2CPR0BK - HPC110BK - S2CPR0BK. Colore disponibile: BK.
- Professional assembled instrument cable with PROEL Ø 6.3 mm Mono jack plug, nickel plated metal housing and gold tip connections/S2CPR0BK - HPC110BK - S2CPR0BK. Available colour: BK.

| DESCRIPTION | LENGHT |
|--------------|------------------|
| STAGE180LU1 | 1 mt (3.28 ft) |
| STAGE180LU2 | 2 mt (6.56 ft) |
| STAGE180LU3 | 3 mt (9.84 ft) |
| STAGE180LU5 | 5 mt (16.40 ft) |
| STAGE180LU6 | 6 mt (19.69 ft) |
| STAGE180LU10 | 10 mt (32.81 ft) |
| STAGE180LU15 | 15 mt (49.21 ft) |
| STAGE180LU20 | 20 mt (65.62 ft) |



HPC110



STAGE185



- Cavo professionale per strumenti con connessioni spina jack Mono Ø 6.3 mm - spina jack Mono Ø 6.3 mm ad angolo PROEL/S2CPR0BK - HPC110BK - S2RCS. Colore disponibile: BK.
- Professional assembled instrument cable with PROEL Ø 6.3 mm Mono jack plug - PROEL Ø 6.3 mm right angle Mono jack plug, nickel plated metal housing and gold tip connections/S2CPR0BK - HPC110BK - S2RCS. Available colour: BK.

| DESCRIPTION | LENGHT |
|--------------|------------------|
| STAGE185LU3 | 3 mt (9.84 ft) |
| STAGE185LU5 | 5 mt (16.40 ft) |
| STAGE185LU10 | 10 mt (32.81 ft) |



HPC110



PROFESSIONAL UNBALANCED CABLES "STAGE INNOVATION" SERIES

PRO CABLES

STAGE290



- Cavo professionale sbilanciato con connessioni spina jack Mono Ø 6.3 mm PROEL - presa volante XLR 3P PROEL/S2CPROBK HPC210BK - XLR3FVPRO. Colore disponibile: BK.
- Professional assembled unbalanced cable with PROEL Ø 6.3 mm Mono jack plug, metal housing and gold tip - PROEL XLR 3P female cable mount connections/S2CPROBK - HPC210BK - XLR3FVPRO. Available colour: BK.

| DESCRIPTION | LENGHT |
|--------------|------------------|
| STAGE290LU1 | 1 mt (3.28 ft) |
| STAGE290LU2 | 2 mt (6.56 ft) |
| STAGE290LU3 | 3 mt (9.84 ft) |
| STAGE290LU5 | 5 mt (16.40 ft) |
| STAGE290LU10 | 10 mt (32.81 ft) |



HPC210



STAGE295



- Cavo professionale sbilanciato con connessioni spina jack Mono Ø 6.3 mm PROEL - spina volante XLR 3P PROEL/S2CPROBK - HPC210BK - XLR3MVPRO. Colore disponibile: BK.
- Professional assembled unbalanced cable with PROEL Ø 6.3 mm Mono jack plug, metal housing and gold tip - PROEL XLR 3P male cable mount connections/S2CPROBK - HPC210BK - XLR3MVPRO. Available colour: BK.

| DESCRIPTION | LENGHT |
|--------------|------------------|
| STAGE295LU1 | 1 mt (3.28 ft) |
| STAGE295LU2 | 2 mt (6.56 ft) |
| STAGE295LU3 | 3 mt (9.84 ft) |
| STAGE295LU5 | 5 mt (16.40 ft) |
| STAGE295LU10 | 10 mt (32.81 ft) |



HPC210



PROFESSIONAL BALANCED CABLES "STAGE INNOVATION" SERIES

STAGE275



- Cavo professionale bilanciato con connessioni presa volante XLR 3P PROEL - spina volante XLR PROEL 3P/XLR3FV - HPC210BK - XLR3MV. Colore disponibile: BK.
- New professional assembled balanced cable with PROEL XLR 3P male female cable mount - PROEL XLR 3P female cable mount connections/XLR3FV - HPC210BK - XLR3MV. Available colour: BK.

| DESCRIPTION | LENGHT |
|--------------|------------------|
| STAGE275LU1 | 1 mt (3.28 ft) |
| STAGE275LU2 | 2 mt (6.56 ft) |
| STAGE275LU3 | 3 mt (9.84 ft) |
| STAGE275LU5 | 5 mt (16.40 ft) |
| STAGE275LU6 | 6 mt (19.69 ft) |
| STAGE275LU10 | 10 mt (32.81 ft) |
| STAGE275LU15 | 15 mt (49.21 ft) |
| STAGE275LU20 | 20 mt (65.62 ft) |



HPC210



STAGE280



- Cavo professionale bilanciato con connessioni presa volante XLR 3P PROEL - spina volante XLR 3P PROEL/XLR3FVPRO - HPC210BK - XLR3MVPRO. Colore disponibile: BK.
- Professional assembled balanced cable with PROEL XLR 3P male female cable mount - PROEL XLR 3P female cable mount, metal housing and backshell connections/XLR3FVPRO - HPC210BK - XLR3MVPRO. Available colour: BK.

| DESCRIPTION | LENGHT |
|--------------|------------------|
| STAGE280LU05 | 0,5 mt (1.64 ft) |
| STAGE280LU1 | 1 mt (3.28 ft) |
| STAGE280LU2 | 2 mt (6.56 ft) |
| STAGE280LU3 | 3 mt (9.84 ft) |
| STAGE280LU5 | 5 mt (16.40 ft) |
| STAGE280LU6 | 6 mt (19.69 ft) |
| STAGE280LU10 | 10 mt (32.81 ft) |
| STAGE280LU15 | 15 mt (49.21 ft) |
| STAGE280LU20 | 20 mt (65.62 ft) |



HPC210



PROFESSIONAL BALANCED CABLES "STAGE INNOVATION" SERIES

PRO CABLES

STAGE330



• Cavo professionale bilanciato con connessioni jack Stereo Ø 6.3 mm PROEL - presa volante XLR 3P PROEL/S3CPROBK - HPC210BK - XLR3FVPRO. Colore disponibile: BK.

• Professional assembled balanced cable with PROEL Ø 6.3 mm Stereo jack plug, metal housing and gold tip - PROEL XLR 3P female cable mount connections/S3CPROBK - HPC210BK - XLR3FVPRO. Available colour: BK.

| DESCRIPTION | LENGHT |
|--------------|------------------|
| STAGE330LU1 | 1 mt (3.28 ft) |
| STAGE330LU2 | 2 mt (6.56 ft) |
| STAGE330LU3 | 3 mt (9.84 ft) |
| STAGE330LU5 | 5 mt (16.40 ft) |
| STAGE330LU10 | 10 mt (32.81 ft) |



HPC210



STAGE335



• Cavo professionale bilanciato con connessioni jack Stereo Ø 6.3 mm PROEL - spina volante XLR 3P PROEL/S3CPROBK - HPC210BK - XLR3MVPRO. Colore disponibile: BK.

• Professional assembled balanced cable with PROEL Ø 6.3 mm Stereo jack plug, metal housing and gold tip - PROEL XLR 3P male cable mount connections/S3CPROBK - HPC210BK - XLR3MVPRO. Available colour: BK.

| DESCRIPTION | LENGHT |
|--------------|------------------|
| STAGE335LU05 | 0.5 mt (1.64 ft) |
| STAGE335LU1 | 1 mt (3.28 ft) |
| STAGE335LU2 | 2 mt (6.56 ft) |
| STAGE335LU3 | 3 mt (9.84 ft) |
| STAGE335LU5 | 5 mt (16.40 ft) |
| STAGE335LU10 | 10 mt (32.81 ft) |



HPC210



STAGE340



• Cavo professionale bilanciato con connessioni jack Stereo Ø 6.3 mm PROEL - jack Stereo Ø 6.3 mm PROEL/S3CPROBK - HPC210BK - S3CPROBK. Colore disponibile: BK.

• Professional assembled balanced cable with PROEL Ø 6.3 mm Stereo jack plug, metal housing and gold tip connections/S3CPROBK - HPC210BK - S3CPROBK. Available colour: BK.

| DESCRIPTION | LENGHT |
|--------------|------------------|
| STAGE340LU05 | 0.5 mt (1.64 ft) |
| STAGE340LU1 | 1 mt (3.28 ft) |
| STAGE340LU2 | 2 mt (6.56 ft) |
| STAGE340LU3 | 3 mt (9.84 ft) |
| STAGE340LU5 | 5 mt (16.40 ft) |
| STAGE340LU10 | 10 mt (32.81 ft) |



HPC210



PASSIVE SPEAKER CABLES "STAGE INNOVATION" SERIES

STAGE690



• Cavo professionale per diffusori acusti passivi - sez. 2 x 1,5 mm² - con connessioni spina jack Ø 6.3 mm Mono PROEL / S290BK - HPC610BK - S290BK. Colore disponibile: BK.

• Professional assembled cable (2 x 1,5mm²) for passive speakers with PROEL Ø 6.3 mm rubber covered Mono jack plug connections/S290BK - HPC610BK - S290BK. Available colour: BK.

| DESCRIPTION | LENGHT |
|--------------|------------------|
| STAGE690LU1 | 1 mt (3.28 ft) |
| STAGE690LU2 | 2 mt (6.56 ft) |
| STAGE690LU3 | 3 mt (9.84 ft) |
| STAGE690LU5 | 5 mt (16.40 ft) |
| STAGE690LU10 | 10 mt (32.81 ft) |



HPC610



PROFESSIONAL DMX CABLES "STAGE INNOVATION" SERIES

PRO CABLES

CVDMX1(3 PIN)



• Cavo professionale DMX per segnale DMX512 con connessioni presa volante XLR 3P PROEL - spina volante XLR 3P PROEL/XLR3FVPRO - DMXD - XLR3MVPRO. Colore disponibile: BK.

• Professional assembled DMX cable for DMX512 signal with PROEL XLR 3P female cable mount - PROEL XLR 3P male cable mount connections/XLR3FVPRO - DMXD - XLR3MVPRO. Available colour: BK.

| DESCRIPTION | LENGHT |
|-------------|------------------|
| CVDMX101 | 1 mt (3.28 ft) |
| CVDMX102 | 2 mt (6.56 ft) |
| CVDMX103 | 3 mt (9.84 ft) |
| CVDMX105 | 5 mt (16.40 ft) |
| CVDMX110 | 10 mt (32.81 ft) |
| CVDMX115 | 15 mt (49.21 ft) |
| CVDMX120 | 20 mt (65.62 ft) |
| CVDMX125 | 25 mt (82.02 ft) |



DMXD



CVDMX2 (5 PIN)



• Cavo professionale DMX per segnale DMX512 con connessioni presa volante XLR 5P PROEL - spina volante XLR 5P PROEL/XLR5FVPRO - DMXD - XLR5MVPRO. Colore disponibile: BK.

• Professional premade DMX cable for DMX512 signal with PROEL XLR 5P female cable mount - PROEL XLR 5P male cable mount connections/XLR5FVPRO - DMXD - XLR5MVPRO. Available colour: BK.

| DESCRIPTION | LENGHT |
|-------------|------------------|
| CVDMX201 | 1 mt (3.28 ft) |
| CVDMX202 | 2 mt (6.56 ft) |
| CVDMX203 | 3 mt (9.84 ft) |
| CVDMX205 | 5 mt (16.40 ft) |
| CVDMX210 | 10 mt (32.81 ft) |
| CVDMX215 | 15 mt (49.21 ft) |
| CVDMX220 | 20 mt (65.62 ft) |
| CVDMX225 | 25 mt (82.02 ft) |



DMXD



• Custom lengths are available on request

PROFESSIONAL PREMADE CABLES "BULK" SERIES

PRO CABLES

BULK

• La serie di cavi assemblati BULK è stata ideata per offrire le migliori connessioni al miglior prezzo possibile. La serie BULK prova che i cavi possono essere accessibili in termini di prezzo senza compromettere la qualità e le caratteristiche di connessione. Connettori caratterizzati da un forte design, cavi di alta qualità uniti ad accuratezza e professionalità nelle operazioni di assemblaggio, permettono alla serie BULK di essere considerata il TOP della propria categoria.

• The PROEL BULK series of premade cables has been developed to provide the best possible connection at the best possible price. BULK proves that cables can be both affordable and accessible without compromising in either quality or features. Highly stylised connectors, high quality cable and unbeatable workmanship set the PROEL BULK series aside as a master in it's class.

Instrument Cables 102



Unbalanced Cables 102

Balanced Cables 103



MIDI Cables 103



Audio Cables 104



DMX Cables 106



Video Cables 106

Video Adapters 107

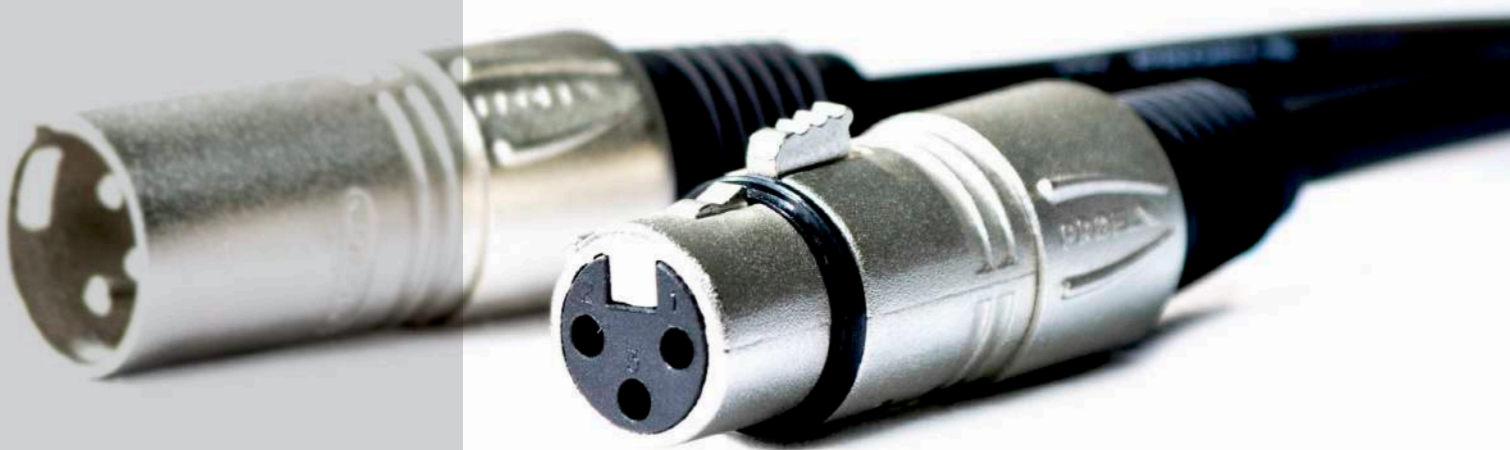

PROFESSIONAL INSTRUMENT CABLES "BULK" SERIES

PRO CABLES

BULK100



- Cavo professionale per strumenti con connessioni spina jack Mono Ø 6.3 mm PROEL/S4CPRS - HPC115 - S4CPRS. Colore disponibile: BK.
- Professional assembled instrument cable with PROEL Ø 6.3 mm Mono jack plug, nickel plated metal housing connections/S4CPRS - HPC115 - S4CPRS. Available colour: BK.

| CODE | LENGHT |
|-------------|------------------|
| BULK100LU05 | 0,5 mt (1.64 ft) |
| BULK100LU1 | 1 mt (3.28 ft) |
| BULK100LU2 | 2 mt (6.56 ft) |
| BULK100LU3 | 3 mt (9.84 ft) |
| BULK100LU5 | 5 mt (16.40 ft) |
| BULK100LU6 | 6 mt (19.69 ft) |
| BULK100LU10 | 10 mt (32.81 ft) |



HPC115



BULK120



- Cavo professionale per strumenti con connessioni spina jack Mono Ø 6.3 mm PROEL - spina jack Mono Ø 6.3 mm ad angolo PROEL/S4CPRS - HPC115 - S4RCS. Colore disponibile: BK.
- Professional assembled instrument cable with PROEL Ø 6.3 mm Mono jack plug - PROEL Ø 6.3 mm right angle Mono jack plug, nickel plated metal housing connections/S4CPRS - HPC115 - S4RCS. Available colour: BK.

| CODE | LENGHT |
|------------|-----------------|
| BULK120LU3 | 3 mt (9.84 ft) |
| BULK120LU5 | 5 mt (16.40 ft) |
| BULK120LU6 | 6 mt (19.69 ft) |



HPC115



BULK130



- Cavo professionale per strumenti con connessioni spina jack Mono Ø 6.3 mm an angolo PROEL - spina jack Mono Ø 6.3 mm ad angolo PROEL/S4RCS - HPC115 - S4RCS. Colore disponibile: BK.
- Professional assembled instrument cable with PROEL Ø 6.3 mm right angle Mono jack plug, nickel plated metal housing connections/S4RCS - HPC115 - S4RCS. Available colour: BK.

| CODE | LENGHT |
|--------------|-------------------|
| BULK130LU015 | 0.15 mt (1.64 ft) |
| BULK130LU03 | 0.3 mt (3.28 ft) |
| BULK130LU05 | 0.5 mt (6.56 ft) |
| BULK130LU1 | 1 mt (9.84 ft) |
| BULK130LU2 | 2 mt (16.40 ft) |



HPC115



PROFESSIONAL UNBALANCED CABLES "BULK" SERIES

BULK200



- Cavo professionale sbilanciato con connessioni spina jack Mono Ø 6.3 mm PROEL - presa volante XLR 3P PROEL/S4CPRS - HPC225 - XLR3FVPRO. Colore disponibile: BK.
- Professional assembled unbalanced cable with PROEL Ø 6.3 mm Mono jack plug, metal housing - PROEL XLR 3P female cable mount, metal housing and backshell connections/S4CPRS - HPC225 - XLR3FVPRO. Available colour: BK.

| CODE | LENGHT |
|-------------|------------------|
| BULK200LU3 | 3 mt (9.84 ft) |
| BULK200LU5 | 5 mt (16.40 ft) |
| BULK200LU6 | 6 mt (19.69 ft) |
| BULK200LU10 | 10 mt (32.81 ft) |



HPC225



BULK220



- Cavo professionale sbilanciato con connessioni spina jack Mono Ø 6.3 mm PROEL - spina volante XLR 3P PROEL/S4CPRS - HPC225 - XLR3MVPRO. Colore disponibile: BK.
- Professional assembled unbalanced cable with PROEL Ø 6.3 mm Mono jack plug, metal housing - PROEL XLR 3P male cable mount, metal housing and backshell connections/S4CPRS - HPC225 - XLR3MVPRO. Available colour: BK.

| CODE | LENGHT |
|-------------|------------------|
| BULK220LU1 | 1 mt (3.28 ft) |
| BULK220LU3 | 3 mt (9.84 ft) |
| BULK220LU5 | 5 mt (16.40 ft) |
| BULK220LU6 | 6 mt (19.69 ft) |
| BULK220LU10 | 10 mt (32.81 ft) |



HPC225



PROFESSIONAL BALANCED CABLES "BULK" SERIES

PRO CABLES

BULK140



• Cavo professionale bilanciato con connessioni spina jack Stereo Ø 6.3 mm PROEL - spina jack Stereo Ø 6.3 mm PROEL/SSCPRO - HPC225 - SSCPRO. Colore disponibile: BK.

• Professional assembled balanced cable with PROEL Ø 6.3 mm Stereo jack plug, metal housing connections/S4CPRO - HPC225 - S4CPRO. Available colour: BK.

| CODE | LENGHT |
|------------|----------------|
| BULK140LU1 | 1 mt (3.28 ft) |
| BULK140LU2 | 2 mt (6.56 ft) |
| BULK140LU3 | 3 mt (9.84 ft) |



HPC225



BULK210



• Cavo professionale bilanciato con connessioni spina jack Stereo Ø 6.3 mm PROEL - presa volante XLR 3P PROEL/SSCPRO - HPC225 - XLR3FVPRO. Colore disponibile: BK.

• Professional assembled balanced cable with PROEL Ø 6.3 mm Stereo jack plug, metal housing - PROEL XLR 3P female cable mount, metal housing and backshell connections/SSCPRO - HPC225 - XLR3FVPRO. Available colour: BK.

| CODE | LENGHT |
|-------------|------------------|
| BULK210LU05 | 0.5 mt (1.64 ft) |
| BULK210LU1 | 1 mt (3.28 ft) |
| BULK210LU2 | 2 mt (6.56 ft) |
| BULK210LU3 | 3 mt (9.84 ft) |
| BULK210LU5 | 5 mt (16.40 ft) |



HPC225



BULK230



• Cavo professionale bilanciato con connessioni jack Stereo Ø 6.3 mm PROEL - spina volante XLR 3P PROEL/SSCPRO - HPC225 - XLR3MVPRO. Colore disponibile: BK.

• Professional assembled balanced cable with PROEL Ø 6.3 mm Stereo jack plug, metal housing - PROEL XLR 3P male cable mount, metal housing and backshell connections/SSCPRO - HPC225 - XLR3MVPRO. Available colour: BK.

| CODE | LENGHT |
|-------------|------------------|
| BULK230LU05 | 0.5 mt (1.64 ft) |
| BULK230LU1 | 1 mt (3.28 ft) |
| BULK230LU2 | 2 mt (6.56 ft) |
| BULK230LU3 | 3 mt (9.84 ft) |
| BULK230LU5 | 5 mt (16.40 ft) |
| BULK230LU10 | 10 mt (32.81 ft) |



HPC225



BULK250



• Cavo professionale bilanciato con connessioni presa volante XLR 3P PROEL - spina volante XLR 3P PROEL/XLR3FVPRO - HPC225 - XLR3MVPRO. Colore disponibile: BK.

• Professional assembled balanced cable with PROEL XLR 3P male cable mount - PROEL XLR 3P female cable mount, metal housing and backshell connections/XLR3FVPRO - HPC225 - XLR3MVPRO. Available colour: BK.

| CODE | LENGHT |
|-------------|------------------|
| BULK250LU05 | 0,5 mt (1.64 ft) |
| BULK250LU1 | 1 mt (3.28 ft) |
| BULK250LU2 | 2 mt (6.56 ft) |
| BULK250LU3 | 3 mt (9.84 ft) |
| BULK250LU5 | 5 mt (16.40 ft) |
| BULK250LU6 | 6 mt (19.69 ft) |
| BULK250LU10 | 10 mt (32.81 ft) |
| BULK250LU15 | 15 mt (49.21 ft) |
| BULK250LU20 | 20 mt (65.62 ft) |



HPC225



MIDI CABLES "BULK" SERIES

BULK410



• Cavo professionale MIDI con connessioni 5P DIN stampate. Colore disponibile: BK.

• Professional assembled MIDI cable with 5P DIN moulded connections. Available colour: BK.

| CODE | LENGHT |
|-------------|------------------|
| BULK410LU15 | 1.5 mt (4.92 ft) |
| BULK410LU3 | 3 mt (9.84 ft) |
| BULK410LU5 | 5 mt (16.40 ft) |



HPC410



PROFESSIONAL AUDIO INTERCONNECTIONS "BULK" SERIES

PRO CABLES

BULK500



- Set di cavi (6 colori diversi) per strumenti con connessioni stampate PROEL spina jack Mono Ø 6.3 mm ad angolo - spina jack Mono Ø 6.3 mm ad angolo. Colori: BK - BL - GN - RD - YE - WH.
- Adapter instrument cable with PROEL Ø 6.3 mm moulded right-angled Mono jack plug connections. Master pack of 6 pcs. Colours: BK - BL - GN - RD - YE - WH.

| CODE | LENGHT |
|--------------|---------------------------|
| BULK500LU015 | 0.15 mt (4.92 ft) - 6 pz. |
| BULK500LU03 | 0.30 mt (9.84 ft) - 6 pz. |



BULK505



- Cavo "INSERT" con connessioni stampate PROEL jack Stereo Ø 3.5 mm - 2 x spina jack Mono Ø 6.3 mm. Colore disponibile: BK.
- Assembled "Y" adapter cable with PROEL Ø 3.5 mm moulded Stereo jack plug - 2 x PROEL Ø 6.3 mm moulded Mono jack plug connections. Available colour: BK.

| CODE | LENGHT |
|-------------|------------------|
| BULK505LU18 | 1.8 mt (5.91 ft) |
| BULK505LU3 | 3 mt (9.84 ft) |



BULK510



- Cavo bilanciato con connessioni stampate PROEL jack Stereo Ø 3.5 mm - jack Stereo Ø 3.5 mm. Colore disponibile: BK.
- Assembled balanced cable with PROEL Ø 3.5 mm moulded Stereo jack plug connections. Available colour: BK.

| CODE | LENGHT |
|-------------|------------------|
| BULK510LU18 | 1.8 mt (5.91 ft) |
| BULK510LU3 | 3 mt (9.84 ft) |



BULK515



- Cavo bilanciato "EXTENSION" con connessioni stampate PROEL jack Stereo Ø 3.5 mm - presa jack Stereo Ø 3.5 mm. Colore disponibile: BK.
- Assembled "EXTENSION" balanced cable with PROEL Ø 3.5 mm moulded Stereo jack plug - PROEL Ø 3.5 mm moulded Stereo jack socket connections. Available colour: BK.

| CODE | LENGHT |
|------------|-----------------|
| BULK515LU3 | 3 mt (9.84 ft) |
| BULK515LU5 | 5 mt (16.40 ft) |



BULK520



- Cavo adattatore "Y - STEREO L/R" con connessioni stampate PROEL spina jack Stereo Ø 3.5 mm - 2 x presa RCA. Colore disponibile: BK.
- Assembled adapter audio "Y-STEREO L/R" cable with PROEL Ø 3.5 mm moulded Stereo jack plug - 2 x PROEL moulded RCA socket connections. Available colour: BK.

| CODE | LENGHT |
|-------------|------------------|
| BULK520LU03 | 0,3 mt (0.98 ft) |



BULK525



- Cavo adattatore "Y - STEREO L/R" con connessioni stampate PROEL presa jack Stereo Ø 3.5 mm - 2 x spina RCA. Colore disponibile: BK.
- Assembled adapter audio "Y-STEREO L/R" cable with PROEL Ø 3.5 mm moulded Stereo jack socket - 2 x PROEL moulded RCA plug connections. Available colour: BK.

| CODE | LENGHT |
|-------------|------------------|
| BULK525LU03 | 0,3 mt (0.98 ft) |



BULK530



- Cavo adattatore con connessioni stampate PROEL spina jack Mono Ø 6.3 mm - spina RCA. Colore disponibile: BK.
- Assembled adapter audio cable with PROEL Ø 6.3 mm moulded Mono jack plug - PROEL moulded RCA plug connections. Available colour: BK.

| CODE | LENGHT |
|-------------|------------------|
| BULK530LU18 | 1.8 mt (5.91 ft) |



PROFESSIONAL AUDIO INTERCONNECTIONS "BULK" SERIES

PRO CABLES

BULK535



- Cavo "INSERT" con connessioni stampate PROEL spina jack Stereo Ø 6.3 mm - 2 x spina jack Mono Ø 6.3mm. Colore disponibile: BK.
- Assembled "INSERT" cable with PROEL Ø 6.3 mm moulded Stereo jack plug - 2 x PROEL Ø 6.3 mm moulded Mono jack plug connections. Available colour: BK.

| CODE | LENGHT |
|-------------|------------------|
| BULK535LU18 | 1,8 mt (5.91 ft) |
| BULK535LU3 | 3 mt (9.84 ft) |



BULK540



- Cavo adattatore "Y" con connessioni stampate PROEL spina jack Stereo Ø 3.5 mm - 2 x spina RCA. Colore disponibile: BK.
- Assembled "Y" adapter cable with PROEL Ø 3.5 mm moulded Stereo jack plug - 2 x PROEL moulded RCA plug connections. Available colour: BK.

| CODE | LENGHT |
|-------------|------------------|
| BULK540LU18 | 1,8 mt (5.91 ft) |
| BULK540LU3 | 3 mt (9.84 ft) |



BULK545



- Cavo audio "STEREO" con connessioni stampate PROEL 2 x spina RCA - 2 x spina RCA. Colore disponibile: BK.
- Assembled "STEREO" cable with 2 x PROEL moulded RCA plug - 2 x PROEL moulded RCA plug connections. Available colour: BK.

| CODE | LENGHT |
|-------------|------------------|
| BULK545LU18 | 1,8 mt (5.91 ft) |
| BULK545LU3 | 3 mt (9.84 ft) |



BULK550



- Cavo adattatore "Y" con connessioni stampate PROEL spina jack Stereo Ø 6.3 mm - 2 x spina RCA. Colore disponibile: BK.
- Assembled "Y" adapter cable with PROEL Ø 6.3 mm moulded Stereo jack plug - 2 x PROEL moulded RCA plug connections. Available colour: BK.

| CODE | LENGHT |
|-------------|------------------|
| BULK550LU18 | 1,8 mt (5.91 ft) |
| BULK550LU3 | 3 mt (9.84 ft) |



BULK555



- Cavo audio "SINGLE LINK" con connessioni stampate PROEL 2 x spina jack Mono Ø 6.3 mm - 2 x spina RCA. Colore disponibile: BK.
- Assembled "SINGLE LINK" audio cable with 2 x PROEL moulded RCA plug - 2 x PROEL Ø 6.3 mm moulded Mono jack plug connections. Available colour: BK.

| CODE | LENGHT |
|-------------|------------------|
| BULK555LU18 | 1,8 mt (5.91 ft) |
| BULK555LU3 | 3 mt (9.84 ft) |



BULK560



- Nuovo cavo audio "STEREO" con connessioni stampate PROEL 2 x jack spina Mono Ø 6.3 mm > 2 x jack spina Mono Ø 6.3 mm. Colore disponibile: BK.
- Assembled "STEREO" audio cable with 2 x PROEL Ø 6.3 mm moulded Mono jack plug - 2 x PROEL Ø 6.3 mm moulded Mono jack plug connections. Available colour: BK.

| CODE | LENGHT |
|-------------|------------------|
| BULK560LU18 | 1,8 mt (5.91 ft) |
| BULK560LU3 | 3 mt (9.84 ft) |



PROFESSIONAL AUDIO INTERCONNECTIONS "BULK" SERIES

PRO CABLES

BULK330 NEW



- Cavo DMX per segnale DMX512 con connessioni presa volante XLR 3P PROEL - spina volante XLR 3P PROEL/ XLR3FVPRON - DMX - XLR3MVPRON. Colore disponibile: BK.
- Premade DMX cable for DMX512 signal with PROEL XLR 3P female cable mount - PROEL XLR 3P male cable mount connections/XLR3FVPRON - DMX - XLR3MVPRON. Available colour: BK.

| CODE | LENGHT |
|-------------|------------------|
| BULK330LU05 | 0,5 mt (1.64 ft) |
| BULK330LU1 | 1 mt (3.28 ft) |
| BULK330LU2 | 2 mt (6.56 ft) |
| BULK330LU3 | 3 mt (9.84 ft) |
| BULK330LU5 | 5 mt (16.40 ft) |
| BULK330LU10 | 10 mt (32.81 ft) |
| BULK330LU15 | 15 mt (49.21 ft) |
| BULK330LU20 | 20 mt (65.62 ft) |



DMX

PROFESSIONAL VIDEO CABLES

PRHDMI

• Cavo HDMI 1.4 con Ethernet, dedicato alle interconnessioni HDTV. Connettori stampati con struttura in metallo per un perfetto contatto elettromagnetico. Contatti dorati ed isolamenti multipli per performance di alto livello e insensibilità alle interferenze EMI e RFI. Massima linearità nella trasmissione del segnale AudioVideo per immagini e audio purissimi. Conduttori in rame OFC individualmente schermati e guaina esterna in PVC ad alta resistenza. Colore disponibile: BK.

• 1.4 HDMI Ethernet cable, dedicated to the HDTV AudioVideo connections. Metal structure molded connectors for a perfect electromechanical contact. Gold plated contacts and multiple Shielding for extreme performances against EMI and RFI interferences. Maximum linearity in signal transmission for the purest images and sound. Individually Shielded OFC conductors and high resistant PVC overall jacket. Available colour: BK.

| CODE | LENGHT |
|-----------|-----------------|
| PRHDMI018 | 1,8 m (5,91 ft) |
| PRHDMI030 | 3 m (9,84 ft) |
| PRHDMI050 | 5 m (16,40 ft) |
| PRHDMI100 | 10 m (32,81 ft) |
| PRHDMI150 | 15 m (49,21 ft) |
| PRHDMI200 | 20 m (65,62 ft) |

PRVGA

• Cavo professionale VGA con connessioni D-SUB 15 poli (con ferrite) principalmente utilizzato per monitor, flat panels e proiettori. Trasporta il segnale video RGBHV con DDC2 digital clock e data. Dotato di nuclei in ferrite antidisturbo per una ottimale trasmissione video e per una qualità superiore del segnale. Le connessioni sono in metallo nichelato e sono resistenti alle corrosioni. Il guscio è realizzato in polietilene resistente alle deformazioni e la guaina esterna è in PVC ad alta resistenza. Colore disponibile: BK.

• Professional VGA cable with D-SUB 15-pin (with ferrites) connections, mainly used for monitors, flat panels and projectors. It carries the video signal in RGBHV with DDC2 digital clock and data. Featuring ferrites noise-free cores for optimal video transmission and a higher quality signal. Corrosion-free nickel-plated metal connections. The shell is made of warp-resistant polyethylene and high resistant PVC overall jacket. Available colour: BK.

| CODE | LENGHT |
|----------|-----------------|
| PRVGA050 | 5 m (16.40 ft) |
| PRVGA100 | 10 m (32.81 ft) |
| PRVGA150 | 15 m (49.21 ft) |
| PRVGA200 | 20 m (65.62 ft) |
| PRVGA250 | 25 m (82,02 ft) |
| PRVGA300 | 30 m (98,43 ft) |



• Linea di cavi AudioVideo assemblati con le più innovative tecnologie e componenti e con connessioni trattate con sistemi anticorrosione. Struttura del cavo estremamente flessibile e resistente, per un ottimale trasferimento del segnale e facilità di installazione.

• AudioVideo interconnection cable series, assembled with innovative technologies and components and with corrosion-free contacts treatment. High resistance extra flexible cable structure for easy installation and durability.

PROFESSIONAL VIDEO ADAPTERS

PRO CABLES



ATV01



ATV02



ATV03



ATV04



ATV05



ATV06



ATV07

• Ampia serie di adattatori professionali per connessioni video. Sono realizzati con corpo in polimeri di plastica ad alta resistenza e contatti in ottone dorato per la massima qualità nella connessione e resistenza alla corrosione.

• Wide range of professional video adapters. They are made of high resistance plastic polymers and with corrosion-free gold plated brass contacts for the highest quality connections.

ATV01

• Adattatore professionale per segnali Video, da connettore VGA femmina a connettore DVI (24+5) femmina. Colore nero con parti in ottone dorato.
• Professional video signal adapter, with VGA female to DVI (24+5) female connections. Black color with gold plated brass parts.

ATV02

• Adattatore professionale per segnali Video, da connettore DVI (24+5) femmina a connettore HDMI maschio. Colore nero con parti in ottone dorato.
• Professional video signal adapter, with DVI (24+5) female to HDMI male connections. Black color with gold plated brass parts.

ATV03

• Adattatore professionale per segnali Video, da connettore DVI (24+5) maschio a connettore HDMI femmina. Colore nero con parti in ottone dorato.
• Professional video signal adapter, with DVI (24+5) male to HDMI female connections. Black color with gold plated brass parts.

ATV04

• Adattatore professionale per segnali Video, da connettore VGA femmina a connettore DVI (24+5) maschio. Colore nero con parti in ottone dorato.
• Professional video signal adapter, with VGA female to DVI (24+5) male connections. Black color with gold plated brass parts.

ATV05

• Adattatore professionale per segnali Video, da connettore HDMI maschio a connettore Micro HDMI maschio. Colore nero con parti in ottone dorato.
• Professional video signal adapter, with HDMI male to Micro HDMI male connections. Black color with gold plated brass parts.

ATV06

• Adattatore professionale ad angolo per segnali Video, da connettore HDMI maschio a connettore HDMI femmina. Colore nero con parti in ottone dorato.
• Professional right angle video signal adapter, with HDMI male to HDMI female connections. Black color with gold plated brass parts.

ATV07

• Adattatore professionale per segnali Video, da connettore HDMI femmina a connettore Mini HDMI maschio. Colore nero con parti in ottone dorato.
• Professional video signal adapter, with HDMI female to Mini HDMI male connections. Black color with gold plated brass parts.

PROFESSIONAL ACTIVE SPEAKER CABLES "PH" SERIES

PRO CABLES

PH080



• Serie di cavi combinati segnale/alimentazione, realizzati con materiali dagli elevati standard qualitativi. Dotati di connettori XLR della serie "PRO" con corpo in metallo e connettori di alimentazione stampati. Cavo di potenza 3*1,5 mm2 combinato con cavo bilanciato AWG24 di alta qualità, adatto alla trasmissione del segnale Audio e del segnale DMX. Questo rende la serie PH080 ideale per collegare diffusori acustici attivi ed apparati di illuminazione DMX. Colore disponibile: BK.

• Series of professional Powered speaker / DMX Combi cables, made of high quality standards materials. Equipped with "PRO" Series XLR connectors with all-metal body and moulded power connectors. 3*1.5 mm2 Power cable combined with AWG22 pair high grade balanced cable, suitable for AUDIO or DMX signal transmission. This makes the PH080 series ideal for connecting active speakers and DMX lighting equipment. Available colour: BK.

| CODE | LENGHT |
|-----------|------------------|
| PH080LU05 | 5 mt (16.40 ft) |
| PH080LU10 | 10 mt (32.81 ft) |
| PH080LU15 | 15 mt (49.21 ft) |
| PH080LU20 | 20 mt (65.62 ft) |

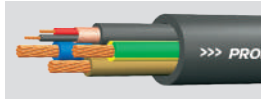

HPC501

PH100



• Cavo professionale Phono-Rete per il collegamento di diffusori acustici attivi. Cavo 3 X 1,5 + 2 x 0,35 - con connessioni presa volante XLR 3P + spina volante SCHUKO 16A - spina volante XLR 3P + presa volante standard EC 3P. Colore disponibile: BK.

• Professional Phono-feed assembled cable with PROEL XLR 3P cable mount female socket, metal housing and backshell + SCHUKO 16A cable mount male plug - 3 x 1,5mm² power cable - PROEL XLR 3P cable mount male plug, metal housing and backshell + EC standard 3P cable mount female socket connections. Available colour: BK.

| CODE | LENGHT |
|-----------|------------------|
| PH100LU5 | 5 mt (16.40 ft) |
| PH100LU10 | 10 mt (32.81 ft) |
| PH100LU15 | 15 mt (49.21 ft) |
| PH100LU20 | 20 mt (65.62 ft) |

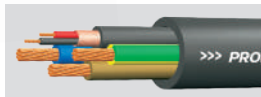

HPC501

PH130*



• Cavo professionale Phono-Rete per il collegamento di diffusori acustici attivi. Cavo 3 X 2,5 + 2 x 0,35 - con connessioni presa volante XLR 3P Neutrik + spina volante SCHUKO 16A - spina volante XLR 3P Neutrik + presa volante "POWERCON" 20A power-in Neutrik. Colore disponibile: BK.

• Professional Phono-feed assembled cable with Neutrik XLR 3P cable mount female socket, black metal housing + SCHUKO 16A cable mount male plug - 3 x 2,5mm² power cable - Neutrik XLR 3P cable mount male plug, black metal housing + Neutrik "Powercon" 20A Blue cable mount female socket "Power In" connections. Available colour: BK.

| CODE | LENGHT |
|-----------|------------------|
| PH130LU10 | 10 mt (32.81 ft) |
| PH130LU15 | 15 mt (49.21 ft) |
| PH130LU20 | 20 mt (65.62 ft) |

* PH130

• This model is also available with a UK 3 pin T3A mains plug instead of the European Schuko - PH130UK

• Custom lengths are available on request

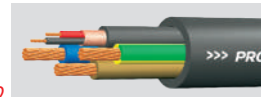

HPC502

PROFESSIONAL ACTIVE SPEAKER CABLES "PH" SERIES

PRO CABLES

PH135



• Cavo professionale Phono-Rete per il collegamento di diffusori acustici attivi. Cavo 3 X 2,5 + 2 x 0,35 - con connessioni presa volante XLR 3P Neutrik + spina CEE 16A - 2P+T - IP44 - 230V ~ - h6 (DIN VDE 0623, EN 60309-2) - spina volante XLR 3P Neutrik + presa volante "POWERCON" 20A power-in Neutrik. Colore disponibile: BK.

• Professional Phono-feed assembled cable with Neutrik XLR 3P cable mount female socket, black metal housing + 16A - 2P+G - 230V - IP44 - h6 plug (DIN VDE 0623, EN 60309-2) - 3 x 2,5mm² power cable - Neutrik XLR 3P cable mount male plug, black metal housing + Neutrik "Powercon" 20A Blue cable mount female socket "Power In" connections. Available colour: BK.

| CODE | LENGHT |
|-----------|------------------|
| PH135LU10 | 10 mt (32.81 ft) |
| PH135LU15 | 15 mt (49.21 ft) |
| PH135LU20 | 20 mt (65.62 ft) |



HPC502

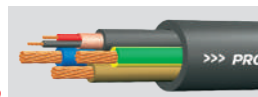

PH140



• Cavo professionale Phono-Rete per il collegamento di diffusori acustici attivi. Cavo 3 X 2,5 + 2 x 0,35 - con connessioni presa volante XLR 3P Neutrik + presa volante "POWERCON" 20A power-out Neutrik - spina volante XLR 3P Neutrik + presa volante "POWERCON" 20A power-in Neutrik. Colore disponibile: BK.

• Professional Phono-feed assembled cable with Neutrik XLR 3P cable mount female socket, black metal housing + Neutrik "Powercon" 20A Grey cable mount female socket "Power Out" - 3 x 2,5mm² power cable - Neutrik XLR 3P cable mount male plug, black metal housing + Neutrik "Powercon" 20A Blue cable mount female socket "Power In" connections. Available colour: BK.

| CODE | LENGHT |
|-----------|------------------|
| PH140LU2 | 2 mt (6.56 ft) |
| PH140LU5 | 5 mt (16.40 ft) |
| PH140LU10 | 10 mt (32.81 ft) |



HPC502

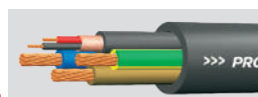

PH145



• Cavo professionale Phono-Rete per il collegamento di diffusori acustici attivi. Cavo 3 X 2,5 + 2 x 0,35 - con connessioni presa volante XLR 3P Neutrik + 1 spina CEE 16A - 2P+T - IP44 - 230V ~ - h6 (DIN VDE 0623, EN 60309-2) - presa volante Neutrik "powerCON TRUE1" di potenza 20A, "POWER IN" system, 3P. Colore disponibile: BK.

• New professional Phono-feed assembled cable with Neutrik XLR 3P cable mount female socket, black metal housing + 16A - 2P+G - 230V - IP44 - h6 plug (DIN VDE 0623, EN 60309-2) - 3 x 2,5mm² power cable - Neutrik XLR 3P cable mount male plug, black metal housing + n. 1 x Neutrik "powerCON TRUE1" 20A cable mount female socket, "POWER IN" system, 3P connections. Available colour: BK.

| CODE | LENGHT |
|-----------|------------------|
| PH145LU10 | 10 mt (32.81 ft) |
| PH145LU15 | 15 mt (49.21 ft) |
| PH145LU20 | 20 mt (65.62 ft) |



HPC502

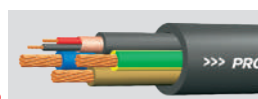

PH150



• Cavo professionale Phono-Rete per il collegamento di diffusori acustici attivi. Cavo 3 X 2,5 + 2 x 0,35 - con connessioni presa volante XLR 3P Neutrik NC3FXXBAG + NAC3MXWTOP spina volante Neutrik "powerCON TRUE1" - spina volante XLR 3P Neutrik NC3MXXBAG + NAC3FXWTOP presa volante Neutrik "powerCON TRUE1". Colore disponibile: BK.

• New professional Phono-feed assembled cable with Neutrik XLR 3P cable mount female socket NC3FXXBAG + Neutrik NAC3MXWTOP cable mount male plug - 3 x 2,5mm² power cable - Neutrik XLR 3P cable mount male plug NC3MXXBAG + Neutrik NAC3FXWTOP cable mount female socket. Available colour: BK.

| CODE | LENGHT |
|------------|------------------|
| PH150LU025 | 2.5 mt (7.62 ft) |
| PH150LU05 | 5 mt (16.40 ft) |
| PH150LU10 | 10 mt (32.81 ft) |



HPC502

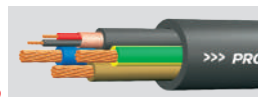

PROFESSIONAL COMBI DMX CABLES "PH" SERIES

PRO CABLES

PH145DMX NEW



• Cavo professionale Combinato DMX + alimentazione per il collegamento di apparati lighting. Cavo 3 X 2,5 + 2 x 0,25 mm² - con connessioni presa volante Neutrik NC3FXXBAG + presa volante "POWERCON" 20A power-in Neutrik NAC3FCA - spina volante XLR 3P Neutrik NC3MXXBAG + presa volante "POWERCON" 20A power-out Neutrik NAC3FCB. Colore disponibile: BK.

• Professional combi DMX + power premade cable for lighting equipment connections with Neutrik NC3FXXBAG cable mount female socket + Neutrik NAC3FCA "POWERCON" 20A Blue cable mount female socket - 3 x 2,5mm² + 2 x 0,25 mm² power cable - Neutrik NC3MXXBAG cable mount male plug + Neutrik NAC3FCB "POWERCON" 20A Gray cable mount female socket connections. Available colour: BK.

| CODE | LENGHT |
|--------------|-----------------|
| PH145LU02DMX | 2 mt (6.56 ft) |
| PH145LU03DMX | 3 mt (9.84 ft) |
| PH145LU04DMX | 4 mt (13.12 ft) |
| PH145LU05DMX | 5 mt (16.40 ft) |



DMXD1

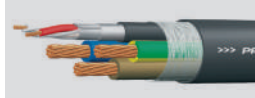

PH155DMX NEW



• Cavo professionale Combinato DMX + alimentazione per il collegamento di apparati lighting. Cavo 3 X 2,5 + 2 x 0,25 mm² - con connessioni presa volante Neutrik NC3FXXBAG + NAC3FXWTOP presa volante Neutrik "powerCON TRUE1" - spina volante XLR 3P Neutrik NC3MXXBAG + NAC3MXWTOP spina volante Neutrik "powerCON TRUE1". Colore disponibile: BK.

• Professional combi DMX + power premade cable for lighting equipment connections with Neutrik NC3FXXBAG cable mount female socket + Neutrik NAC3FXWTOP cable mount female socket - 3 x 2,5mm² + 2 x 0,25 mm² power cable - Neutrik NC3MXXBAG cable mount male plug + Neutrik NAC3MXWTOP cable mount male plug connections. Available colour: BK.

| CODE | LENGHT |
|--------------|-----------------|
| PH155LU02DMX | 2 mt (6.56 ft) |
| PH155LU03DMX | 3 mt (9.84 ft) |
| PH155LU04DMX | 4 mt (13.12 ft) |
| PH155LU05DMX | 5 mt (16.40 ft) |



DMXD1

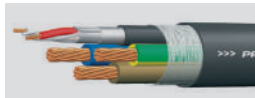

• Custom lengths are available on request

PROFESSIONAL STUDIO LOOM "ESOTERIC" SERIES

PRO CABLES

PBSL04NJSJS



• Cavo professionale multipolare analogico bilanciato per studi di registrazione con connessioni 4 x spina jack Stereo Ø 6.3 mm Neutrik - 4 x spina jack Stereo Ø 6.3 mm Neutrik/NP3X - CM14 - NP3X. Colore disponibile: Nero.
 • Professional assembled analogic "Studio Loom" with 4 x Neutrik Ø 6.3 mm Stereo jack plug - 4 x Neutrik Ø 6.3 mm Stereo jack plug connections/NP3X - CM14 - NP3X. Available colour: BK.

| CODE | LENGHT |
|---------------|-----------------|
| PBSL04NJSJS03 | 3 mt (9.84 ft) |
| PBSL04NJSJS04 | 4 mt (13.12 ft) |
| PBSL04NJSJS05 | 5 m (16.40 ft) |
| PBSL04NJSJS10 | 10 m (32.81 ft) |



PBSL04NXX



• Cavo professionale multipolare analogico bilanciato per studi di registrazione con connessioni 4 x presa volante XLR 3P Neutrik - 4 x spina volante XLR 3P Neutrik / NC3FXX - CM14 - NC3MXX. Colore disponibile: Nero.
 • Professional assembled analogic "Studio Loom" with 4 x Neutrik XLR 3P female cable mount - 4 x Neutrik XLR 3P male cable mount connections / NC3FXX - CM14 - NC3MXX. Available colour: BK.

| CODE | LENGHT |
|-------------|-----------------|
| PBSL04NXX03 | 3 mt (9.84 ft) |
| PBSL04NXX04 | 4 mt (13.12 ft) |
| PBSL04NXX05 | 5 m (16.40 ft) |
| PBSL04NXX10 | 10 m (32.81 ft) |



PBSL08NJSJS



• Cavo professionale multipolare analogico bilanciato per studi di registrazione con connessioni 8 x spina jack Stereo Ø 6.3 mm Neutrik - 8 x spina jack Stereo Ø 6.3 mm Neutrik/NP3X - CM18 - NP3X. Colore disponibile: Nero.
 • Professional assembled analogic "Studio Loom" with 8 x Neutrik Ø 6.3 mm Stereo jack plug - 8 x Neutrik Ø 6.3 mm Stereo jack plug connections/NP3X - CM18 - NP3X. Available colour: BK.

| CODE | LENGHT |
|---------------|-----------------|
| PBSL08NJSJS03 | 3 mt (9.84 ft) |
| PBSL08NJSJS04 | 4 mt (13.12 ft) |
| PBSL08NJSJS05 | 5 m (16.40 ft) |
| PBSL08NJSJS10 | 10 m (32.81 ft) |



PBSL08NXX



• Cavo professionale multipolare analogico bilanciato per studi di registrazione con connessioni 8 x presa volante XLR 3P Neutrik - 8 x spina volante XLR 3P Neutrik / NC3FXX - CM18 - NC3MXX. Colore disponibile: Nero.
 • Professional assembled analogic "Studio Loom" with 8 x Neutrik XLR 3P female cable mount - 8 x Neutrik XLR 3P male cable mount connections / NC3FXX - CM18 - NC3MXX. Available colour: BK.

| CODE | LENGHT |
|-------------|-----------------|
| PBSL08NXX03 | 3 mt (9.84 ft) |
| PBSL08NXX04 | 4 mt (13.12 ft) |
| PBSL08NXX05 | 5 m (16.40 ft) |
| PBSL08NXX10 | 10 m (32.81 ft) |



PROFESSIONAL STUDIO LOOM "ESOTERIC" SERIES

PRO CABLES

PBSL08NJSXF

NEW



• Cavo professionale multipolare analogico bilanciato per studi di registrazione con connessioni 8 x spina jack Stereo Ø 6.3 mm Neutrik - 8 x presa volante XLR 3P Neutrik/NP3X - CM18 - NC3FXX. Colore disponibile: BK.
 • Professional assembled analogic "Studio Loom" with 8 x Neutrik Ø 6.3 mm Stereo jack plug - 8 x Neutrik XLR 3P female cable mount connections/NP3X - CM18 - NC3FXX. Available colour: BK.

| CODE | LENGHT |
|---------------|-----------------|
| PBSL08NJSXF03 | 3 mt (9.84 ft) |
| PBSL08NJSXF04 | 4 mt (13.12 ft) |
| PBSL08NJSXF05 | 5 m (16.40 ft) |
| PBSL08NJSXF10 | 10 m (32.81 ft) |



PBSL08NJSXM

NEW



• Cavo professionale multipolare analogico bilanciato per studi di registrazione con connessioni 8 x spina jack Stereo Ø 6.3 mm Neutrik - 8 x spina volante XLR 3P Neutrik/NP3X - CM18 - NC3MXX. Colore disponibile: BK.
 • Professional assembled analogic "Studio Loom" with 8 x Neutrik Ø 6.3 mm Stereo jack plug - 8 x Neutrik XLR 3P male cable mount connections/NP3X - CM18 - NC3MXX. Available colour: BK.

| CODE | LENGHT |
|---------------|-----------------|
| PBSL08NJSXM03 | 3 mt (9.84 ft) |
| PBSL08NJSXM04 | 4 mt (13.12 ft) |
| PBSL08NJSXM05 | 5 m (16.40 ft) |
| PBSL08NJSXM10 | 10 m (32.81 ft) |



PROFESSIONAL STUDIO LOOM "STAGE INNOVATION" SERIES

PBSL04PXX

NEW



• Cavo professionale multipolare analogico bilanciato per studi di registrazione con connessioni 4 x presa volante XLR 3P - 4 x spina volante XLR 3P / XLR3FVPRO - CM14 - XLR3MVP. Colore disponibile: BK.
 • Professional assembled analogic "Studio Loom" with 4 x XLR 3P female cable mount - 4 x XLR 3P male cable mount connections / XLR3FVPRO - CM14 - XLR3MVP. Available colour: BK.

| CODE | LENGHT |
|-------------|-----------------|
| PBSL04PXX03 | 3 mt (9.84 ft) |
| PBSL04PXX04 | 4 mt (13.12 ft) |
| PBSL04PXX05 | 5 m (16.40 ft) |
| PBSL04PXX10 | 10 m (32.81 ft) |



PBSL08PXX

NEW



• Cavo professionale multipolare analogico bilanciato per studi di registrazione con connessioni 8 x presa volante XLR 3P - 8 x spina volante XLR 3P / XLR3FVPRO - CM18 - XLR3MVP. Colore disponibile: BK.
 • Professional assembled analogic "Studio Loom" with 8 x XLR 3P female cable mount - 8 x XLR 3P male cable mount connections / XLR3FVPRO - CM18 - XLR3MVP. Available colour: BK.

| CODE | LENGHT |
|-------------|-----------------|
| PBSL08PXX03 | 3 mt (9.84 ft) |
| PBSL08PXX04 | 4 mt (13.12 ft) |
| PBSL08PXX05 | 5 m (16.40 ft) |
| PBSL08PXX10 | 10 m (32.81 ft) |

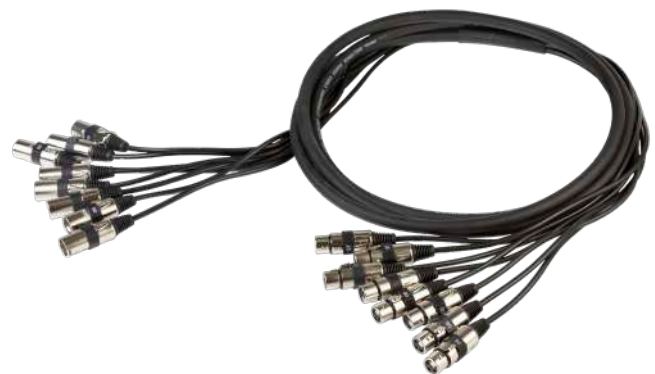

• Custom lengths are available on request

PROFESSIONAL STUDIO LOOM "ESOTERIC" SERIES

PRO CABLES

ADAT200JSTN

NEW



• Cavo professionale multipolare analogico bilanciato per studi di registrazione con connessioni 1 x SUB "D" 25 pin - 8 x spina jack Stereo Ø 6.3 mm Neutrik/SUB "D" 25 pin - CM18 - NP3X. Piedinatura TASCAM. Colore disponibile: BK.
 • Professional assembled analogic "Studio Loom" with 1 x 25 pin SUB "D" - Neutrik Ø 6.3 mm Stereo jack plug connections/25 pin SUB "D" - CM18 - NP3X. TASCAM pinout. Available colour: BK.

| CODE | LENGHT |
|---------------|----------------|
| ADAT200JSTN02 | 2 mt (6.56 ft) |
| ADAT200JSTN03 | 3 mt (9.84 ft) |
| ADAT200JSTN04 | 4 m (13.12 ft) |
| ADAT200JSTN05 | 5 m (16.40 ft) |



ADAT200FXTN

NEW



• Cavo professionale multipolare analogico bilanciato per studi di registrazione con connessioni 1 x SUB "D" 25 pin - 8 x presa volante XLR 3P Neutrik/SUB "D" 25 pin - CM18 - NC3FXX. Piedinatura TASCAM. Colore disponibile: BK.
 • Professional assembled analogic "Studio Loom" with 1 x 25 pin SUB "D" - 8 x Neutrik XLR 3P female cable mount connections/25 pin SUB "D" - CM18 - NC3FXX. TASCAM pinout. Available colour: BK.

| CODE | LENGHT |
|---------------|----------------|
| ADAT200FXTN02 | 2 mt (6.56 ft) |
| ADAT200FXTN03 | 3 mt (9.84 ft) |
| ADAT200FXTN04 | 4 m (13.12 ft) |
| ADAT200FXTN05 | 5 m (16.40 ft) |



ADAT200MXTN

NEW



• Cavo professionale multipolare analogico bilanciato per studi di registrazione con connessioni 1 x SUB "D" 25 pin - 8 x presa volante XLR 3P Neutrik/SUB "D" 25 pin - CM18 - NC3MXX. Piedinatura TASCAM. Colore disponibile: BK.
 • Professional assembled analogic "Studio Loom" with 1 x 25 pin SUB "D" - 8 x Neutrik XLR 3P male cable mount connections/25 pin SUB "D" - CM18 - NC3MXX. TASCAM pinout. Available colour: BK.

| CODE | LENGHT |
|---------------|----------------|
| ADAT200MXTN02 | 2 mt (6.56 ft) |
| ADAT200MXTN03 | 3 mt (9.84 ft) |
| ADAT200MXTN04 | 4 m (13.12 ft) |
| ADAT200MXTN05 | 5 m (16.40 ft) |



ADAT220DN

NEW



• Cavo professionale multipolare digitale per studi di registrazione con connessioni 1 x SUB "D" 25 pin - 4 x presa volante XLR 3P - 4 x spina volante XLR 3P / SUB "D" 25 pin - CMD08 - NC3FXX/NC3MXX. Colore disponibile: BK.
 • Professional assembled digital "Studio Loom" with 25 pin SUB "D" - 4 x XLR 3P female cable mount - 4 x XLR 3P male cable mount connections / SUB "D" 25 pin - CMD08 - NC3FXX/NC3MXX. Available colour: BK.

| CODE | LENGHT |
|-------------|----------------|
| ADAT200DN02 | 2 mt (6.56 ft) |
| ADAT200DN03 | 3 mt (9.84 ft) |
| ADAT200DN04 | 4 m (13.12 ft) |
| ADAT200DN05 | 5 m (16.40 ft) |



PROFESSIONAL STUDIO LOOM "STAGE INNOVATION" SERIES

PRO CABLES

ADAT200JSTP



• Cavo professionale multipolare analogico bilanciato per studi di registrazione con connessioni 1 x SUB "D" 25 pin - 8 x spina jack Stereo Ø 6.3 mm Neutrik/SUB "D" 25 pin - CM18 - SC3PROBK. Piedinatura TASCAM. Colore disponibile: BK.
 • Professional assembled analogic "Studio Loom" with 1 x 25 pin SUB "D" - Neutrik Ø 6.3 mm Stereo jack plug connections/25 pin SUB "D" - CM18 - SC3PROBK. TASCAM pinout. Available colour: BK.

| CODE | LENGHT |
|---------------|----------------|
| ADAT200JSTP02 | 2 mt (6.56 ft) |
| ADAT200JSTP03 | 3 mt (9.84 ft) |
| ADAT200JSTP04 | 4 m (13.12 ft) |
| ADAT200JSTP05 | 5 m (16.40 ft) |



ADAT200FXTP



• Cavo professionale multipolare analogico bilanciato per studi di registrazione con connessioni 1 x SUB "D" 25 pin - 8 x presa volante XLR 3P Proel/SUB "D" 25 pin - CM18 - XLR3FVPRO. Piedinatura TASCAM. Colore disponibile: BK.
 • Professional assembled analogic "Studio Loom" with 1 x 25 pin SUB "D" - 8 x Proel XLR 3P female cable mount connections/25 pin SUB "D" - CM18 - XLR3FVPRO. TASCAM pinout. Available colour: BK.

| CODE | LENGHT |
|---------------|----------------|
| ADAT200FXTP02 | 2 mt (6.56 ft) |
| ADAT200FXTP03 | 3 mt (9.84 ft) |
| ADAT200FXTP04 | 4 m (13.12 ft) |
| ADAT200FXTP05 | 5 m (16.40 ft) |



ADAT200MXTP



• Cavo professionale multipolare analogico bilanciato per studi di registrazione con connessioni 1 x SUB "D" 25 pin - 8 x spina volante XLR 3P Proel/SUB "D" 25 pin - CM18 - XLR3MVPRO. Piedinatura TASCAM. Colore disponibile: BK.
 • Professional assembled analogic "Studio Loom" with 1 x 25 pin SUB "D" - 8 x Proel XLR 3P male cable mount connections/25 pin SUB "D" - CM18 - XLR3MVPRO. TASCAM pinout. Available colour: BK.

| CODE | LENGHT |
|---------------|----------------|
| ADAT200MXTP02 | 2 mt (6.56 ft) |
| ADAT200MXTP03 | 3 mt (9.84 ft) |
| ADAT200MXTP04 | 4 m (13.12 ft) |
| ADAT200MXTP05 | 5 m (16.40 ft) |



• Custom lengths are available on request

ASSEMBLED CABLE DRUM "AVCAT PRO" SERIES

PRO CABLES



AVCAT5PRO



• Cavo professionale PROEL LAN5S – Cat. 5e S-FTP – PUR, assemblato su avvolgitore professionale Proel – AV190, con connettori schermati RJ45 HIROSE serie TM21DP di alta qualità e gusci NEUTRIK NE8MX1. Disponibile in differenti lunghezze standard. Sono inoltre disponibili delle ulteriori configurazioni a richiesta. Colore disponibile: BK.

• PROEL LAN5S - Cat5e S-FTP - PUR professional Cable, assembled on AV190 Proel professional cable drum, featuring high quality HIROSE Shielded TM21DP Series RJ45 plugs and NEUTRIK NE8MX1 carriers. Available in different standard lengths. Other configurations are also available on request. Available colour: BK.

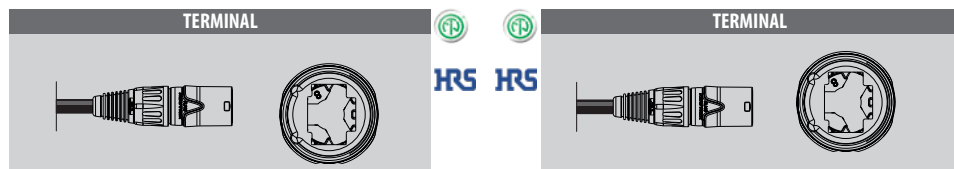

| Code | Terminals | Inputs | Outputs | Cable | Length |
|-------------|-----------|--------|---------|-------|-----------------|
| AVCAT5PRO30 | | RJ45 | RJ45 | LAN5S | 30 mt - 99 ft. |
| AVCAT5PRO50 | | | | | 50 mt - 165 ft. |
| AVCAT5PRO75 | | | | | 75 mt - 246 ft. |



AVCAT5PROHH



• Prodotto con le stesse caratteristiche dell'AVCAT5PRO standard, ma con connettori HIROSE serie TM21DP, con plug RJ45 schermato e custodia a clip in plastica di colore nero, senza gusci Neutrik. Colore disponibile: BK.

• Product with same AVCAT5PRO standard features, but with HIROSE TM21DP Series Shielded RJ45 plugs provided with plastic clip case, without NEUTRIK carriers. Available colour: BK.

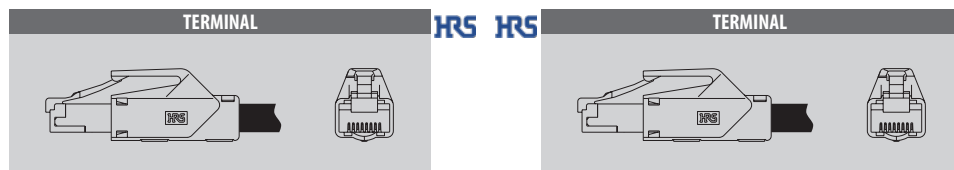

| Code | Terminals | Inputs | Outputs | Cable | Length |
|---------------|-----------|--------|---------|-------|-----------------|
| AVCAT5PRO30HH | | RJ45 | RJ45 | LAN5S | 30 mt - 99 ft. |
| AVCAT5PRO50HH | | | | | 50 mt - 165 ft. |
| AVCAT5PRO75HH | | | | | 75 mt - 246 ft. |

PROFESSIONAL NETWORK CABLE "AVCAT PRO" SERIES

PRO CABLES



AVCAT6PRO



• Cavo professionale PROEL LAN6S – Cat6 S-UTP – PUR, assemblato su avvolgitore professionale PROEL AV190, con connettori RJ45 Cat6A di alta qualità NEUTRIK NE8MX6T. Indicato per utilizzi professionali. Disponibile in differenti lunghezze standard. Sono inoltre disponibili delle ulteriori configurazioni a richiesta. Colore disponibile: BK.

• PROEL LAN6S - Cat6 S-UTP - PUR professional networking Cable, assembled on Proel AV190 professional cable drum, featuring high quality RJ45 Cat6A NEUTRIK NE8MX6T connectors. Suitable for professional use. Available in different standard lengths. Other configurations are also available on request. Available colour: BK.

| Code | Terminals | Inputs | | Outputs | | Cable | Length |
|-------------|-----------|--------|---------|---------|---------|-------|-----------------|
| | | Inputs | Outputs | Inputs | Outputs | | |
| AVCAT6PRO30 | | | | | | LAN6S | 30 mt - 99 ft. |
| AVCAT6PRO50 | | RJ45 | RJ45 | RJ45 | RJ45 | LAN6S | 50 mt - 165 ft. |
| AVCAT6PRO75 | | | | | | LAN6S | 75 mt - 246 ft. |



AVCAT6UPRO



• Cavo professionale PROEL LAN6UTP – Cat. 6 UTP – PUR, assemblato su avvolgitore professionale Proel - AV190, con connettori schermati RJ45 HIROSE serie TM21DP di alta qualità e gusci NEUTRIK NE8MX1. Disponibile in differenti lunghezze standard. Sono inoltre disponibili delle ulteriori configurazioni a richiesta. Colore disponibile: BK.

• PROEL LAN6UTP - Cat. 6 UTP - PUR professional Cable, assembled on AV190 Proel professional cable drum, featuring high quality HIROSE Shielded TM21DP Series RJ45 plugs and NEUTRIK NE8MX1 carriers. Available in different standard lengths. Other configurations are also available on request. Available colour: BK.

| Code | Terminals | Inputs | | Outputs | | Cable | Length |
|--------------|-----------|--------|---------|---------|---------|---------|-----------------|
| | | Inputs | Outputs | Inputs | Outputs | | |
| AVCAT6UPRO30 | | | | | | LAN6UTP | 30 mt - 99 ft. |
| AVCAT6UPRO50 | | RJ45 | RJ45 | RJ45 | RJ45 | LAN6UTP | 50 mt - 165 ft. |
| AVCAT6UPRO75 | | | | | | LAN6UTP | 75 mt - 246 ft. |

PROFESSIONAL NETWORK CABLE "CAT PRO" SERIES

PRO CABLES



CAT5S



• Cavo professionale PROEL LAN5S – Cat. 5e S-FTP – PUR, assemblato con connettori schermati RJ45 HIROSE serie TM21DP di alta qualità e gusci NEUTRIK NE8MX1. Disponibile in differenti lunghezze standard. Sono inoltre disponibili delle ulteriori configurazioni a richiesta. Colore disponibile: BK.
 • PROEL LAN5S - Cat5e S-FTP - PUR professional Cable, assembled with high quality HIROSE Shielded TM21DP Series RJ45 plugs and NEUTRIK NE8MX1 carriers. Available in different standard lengths. Other configurations are also available on request. Available colour: BK.

| CODE | LENGTH |
|------------|------------------|
| CAT5SSLU05 | 0,5 mt (1.64 ft) |
| CAT5SSLU1 | 1,0 mt (3.28 ft) |
| CAT5SSLU2 | 2,0 mt (6.56 ft) |
| CAT5SSLU3 | 3,0 mt (9.84 ft) |

| CODE | LENGTH |
|------------|------------------|
| CAT5SSLU5 | 5 mt (16.40 ft) |
| CAT5SSLU10 | 10 mt (32.81 ft) |
| CAT5SSLU15 | 15 mt (49.21 ft) |
| CAT5SSLU20 | 20 mt (65.62 ft) |



CAT5SH



• Prodotto con le stesse caratteristiche del CAT5S, con connettori RJ45 HIROSE serie TM21DP schermati, ma con guscio NEUTRIK NE8MX1 solo da un lato. Colore disponibile: BK.
 • Product with same CAT5S features, with HIROSE TM21DP Series Shielded RJ45 plugs but with NEUTRIK NE8MX1 cable carrier on one side only. Available colour: BK.

| CODE | LENGTH |
|-------------|------------------|
| CAT5SSLU05H | 0,5 mt (1.64 ft) |
| CAT5SSLU1H | 1 mt (3.28 ft) |
| CAT5SSLU2H | 2 mt (6.56 ft) |
| CAT5SSLU3H | 3 mt (9.84 ft) |

| CODE | LENGTH |
|-------------|------------------|
| CAT5SSLU5H | 5 mt (16.40 ft) |
| CAT5SSLU10H | 10 mt (32.81 ft) |
| CAT5SSLU15H | 15 mt (49.21 ft) |
| CAT5SSLU20H | 20 mt (65.62 ft) |



CAT5SDH



• Prodotto con le stesse caratteristiche del CAT5S, con connettori RJ45 HIROSE serie TM21DP schermati e custodia a clip in plastica di colore nero, senza gusci NEUTRIK. Colore disponibile: BK.
 • Product with same CAT5S features, with HIROSE TM21DP Series Shielded RJ45 plugs with plastic clip, without NEUTRIK cable carriers. Available colour: BK.

| CODE | LENGTH |
|--------------|------------------|
| CAT5SSLU05DH | 0,5 mt (1.64 ft) |
| CAT5SSLU1DH | 1 mt (3.28 ft) |
| CAT5SSLU2DH | 2 mt (6.56 ft) |
| CAT5SSLU3DH | 3 mt (9.84 ft) |

| CODE | LENGTH |
|--------------|------------------|
| CAT5SSLU5DH | 5 mt (16.40 ft) |
| CAT5SSLU10DH | 10 mt (32.81 ft) |
| CAT5SSLU15DH | 15 mt (49.21 ft) |
| CAT5SSLU20DH | 20 mt (65.62 ft) |



CAT6UTPH NEW



• Cavo professionale PROEL LAN6UTP – Cat. 6 UTP – PUR, assemblato con connettori schermati RJ45 HIROSE serie TM21DP di alta qualità schermati e custodia a clip in plastica di colore nero. Disponibile in differenti lunghezze standard. Sono inoltre disponibili delle ulteriori configurazioni a richiesta. Colore disponibile: BK.
 • PROEL LAN6UTP - Cat. 6 UTP - PUR professional Cable, assembled with HIROSE TM21DP Series Shielded RJ45 plugs with plastic clip. Available in different standard lengths. Other configurations are also available on request. Available colour: BK.

| CODE | LENGTH |
|---------------|------------------|
| CAT6UTPHLU005 | 0,5 mt (1.64 ft) |
| CAT6UTPHLU01 | 1 mt (3.28 ft) |
| CAT6UTPHLU02 | 2 mt (6.56 ft) |
| CAT6UTPHLU03 | 3 mt (9.84 ft) |

| CODE | LENGTH |
|--------------|------------------|
| CAT6UTPHLU05 | 5 mt (16.40 ft) |
| CAT6UTPHLU10 | 10 mt (32.81 ft) |
| CAT6UTPHLU15 | 15 mt (49.21 ft) |
| CAT6UTPHLU20 | 20 mt (65.62 ft) |



PROFESSIONAL MAIN CABLES "SM" SERIES

PRO CABLES

SM200

- Cavo di alimentazione - 3 x 1mm² - con connessioni presa volante EC standard 3P - spina volante EC standard 3P. Colore disponibile: BK.
- PROEL assembled Power cable (3 x 1 mm²) with EC standard 3P cable mount female socket - EC standard 3P cable mount male plug connections. Available colour: BK.

| CODE | LENGHT |
|-----------|------------------|
| SM200LU25 | 2,5 mt (8.20 ft) |

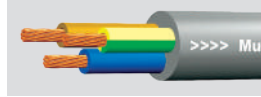

SM300

- Cavo di alimentazione - 3 x 1mm² - con connessioni presa volante EC standard 3P - spina volante SCHUKO 16A. Colore disponibile: BK.
- PROEL assembled Power cable (3 x 1 mm²) with EC standard 3P cable mount female socket - SCHUKO 16A standard 3P cable mount male plug connections. Available colour: BK.

| CODE | LENGHT |
|-----------|------------------|
| SM300LU25 | 2.5 mt (7.62 ft) |
| SM300LU5 | 5 mt (16.40 ft) |
| SM300LU10 | 10 mt (32.81 ft) |
| SM300LU15 | 15 mt (49.21 ft) |

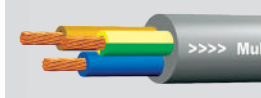

PATCH CABLES & ACCESSORIES "SPB" SERIES

SPB30 - SPB60



- Confezione di nr. 6 cavi patch bilanciati di diversi colori, con connessioni stampate PROEL spina jack Stereo Ø 6.3 mm - spina jack Stereo Ø 6.3 mm. Colori: BK - BL - GN - RD - YE - WH.
- Assembled balanced patch-cord with PROEL Ø 6.3 mm moulded Stereo jack plug connections. Master pack of 6 pcs. Colours: BK - BL - GN - RD - YE - WH.

| CODE | LENGHT |
|----------------|------------------|
| SPB30 (6 pcs.) | 0.3 mt (0.98 ft) |
| SPB60 (6 pcs.) | 0.6 mt (1.97 ft) |



CABLET02

- Cable tester professionale, adatto a testare cavi assemblati con molteplici tipologie di connessioni: 3.5 & 6.35 Mono e Stereo - XLR 3 poli bilanciati (M/F) - Connettori RCA - Speakon 2, 4 & 8 poli - RJ45 - DIN 8 poli - S/Video - USB A/USB B - Midi. L'accensione del LED conferma la corretta connessione tra i connettori. Funzionamento con 2 batterie 1,5V non incluse. Confezione: 1 pezzo.

- Professional cable tester. Test cables with many different connector types: 3.5mm & 6.35mm MONO / TRS - 3 pins balanced XLR (M/F) - Phono/RCA - 2P, 4P & 8P Speakon - RJ45 - 8 Pin mini DIN - S/Video - USB A/USB B - Midi. LEDs confirm correct connections between the connectors. It works with 2x1,5V battery not included. Master pack: 1 pc.



VELCRO TIES PRO CABLES

WRAPIT

• Confezione di nr. 6 fascette in Velcro serracavi multiuso (raggruppamento cavi, camping, tempo libero). Le bande di velcro WRAPIT sono estremamente flessibili e permettono il serraggio sicuro dei cavi senza l'utilizzo di lacci di nylon grazie all'occhiello terminale. Dimensioni: 12 x 300 mm. Diametro massimo di raggruppamento: 40 mm. Colore disponibile: nero.

• *Multi-purpose self gripping ties (cable management, outdoor & leisure). WRAPIT features 6 x 300 mm length flexible double sided hook & loop fastener with a slide-through eyelet to lock the fastener to the cable without the use of nylon loops. Dimensions: 12 x 300 mm. Maximum bundling diameter: 40 mm. Quantity: 6 per pack. Master pack: 1 pc. Available colour: BK.*

| TECH INFO | LENGTH | | |
|-----------|-------------|------------------|---------------|
| WRAPIT | 12 x 300 mm | (0.03 x 0.98 ft) | 1 set (6 pcs) |



TIE

• Confezione di n° 10 bande in velcro serracavi professionali multiuso con anello in metallo. Colore disponibile: nero. Dimensioni: 10 x 120 mm (TIE1012) - 20 x 200 mm (TIE2020) - 20 x 300 mm (TIE2030). Colore disponibile: nero.

• *Professional 10 pieces set of multi-purpose Velcro cable tie with metal hook for a permanent non-sliding cable mounting & tough. Dimensions: 10 x 120 mm (TIE1210) - 20 x 200 mm (TIE2020) - 20 x 300 mm (TIE2030). Available colour: BK.*

| TECH INFO | LENGTH | | |
|-----------|-------------|------------------|----------------|
| TIE1012 | 10 x 120 mm | (0.03 x 0.39 ft) | 1 set (10 pcs) |
| TIE2020 | 20 x 200 mm | (0.06 x 0.65 ft) | 1 set (10 pcs) |
| TIE2030 | 20 x 300 mm | (0.06 x 0.98 ft) | 1 set (10 pcs) |

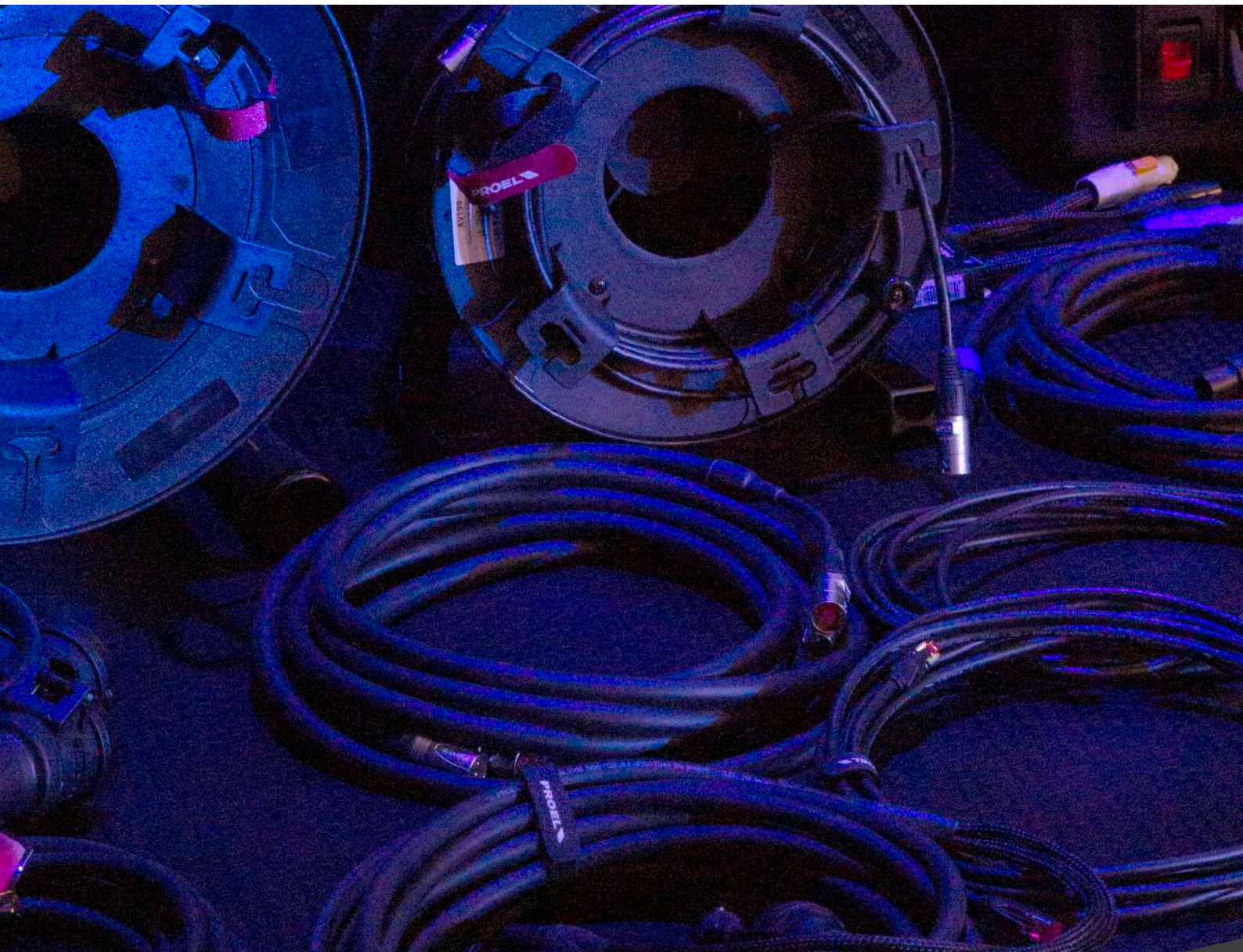

CABLES IN REEL

• Grazie alla capillare presenza sul mercato ed ai feedback ricevuti, l'azienda è costantemente impegnata nell'ampliamento della gamma dei prodotti, con riguardo anche ad ambiti diversi da quelli normalmente gestiti, come la domotica, il public address, l'home theatre, la luce architettonica, l'installazione nei luoghi di culto e nel navale. L'azienda riesce a sviluppare prodotti unici ed innovativi in grado di offrire molteplici soluzioni per soddisfare qualsiasi esigenza o richiesta da parte del cliente, dal semplice cavo per il musicista fino alle grandi installazioni.

• *Thanks to its widespread presence in the market and the feedback received, the company is constantly engaged in broadening the range of products, including those matters than normally the company doesn't deal with, such as home automation, public address, home theatre, architectural lighting, installations in worships and in shipbuildings. The company is able to develop unique and innovative products to offer multiple solutions to meet any need or request of the client, from simple cable for the musician to bigger installations.*



PARTNERSHIP CABLES IN REEL

- La forte partnership stabilita con alcune tra le più importanti aziende di produzione Italiane, fa in modo che tutti i cavi siano prodotti mediante l'utilizzo di tecnologie ed attrezzature di ultima generazione, accompagnate da un'accurata selezione delle materie prime impiegate. Tutto ciò consente a Proel di essere sempre all'avanguardia nel mercato internazionale.

- *The strong partnership established with some of the most important Italian manufacturing companies, makes sure that all cables are produced through the use of the latest technologies and equipments, accompanied by a careful selection of raw materials. All that allows Proel be at the forefront in the international market.*



CUSTOMIZATION

- Gli obiettivi di Proel sono da sempre focalizzati sulla soddisfazione del cliente, sulla qualità dei prodotti offerti ed il loro sviluppo, al passo con il progresso tecnologico, l'innovazione, la creatività, l'efficienza. La grande flessibilità aziendale consente di soddisfare le esigenze di ogni singolo cliente, riuscendo così a creare dei prodotti "custom", seguendo e curando ogni minimo dettaglio tecnico, per proseguire con la stampa ed il confezionamento personalizzati e fino all'organizzazione del trasporto.

- *Proel goals have always been focused on customer satisfaction, quality of products and their development, keeping pace with technological progress, innovation, creativity and efficiency. The flexibility allows the company to meet the needs of each customer, allowing them to create "custom" products, following and taking care of every technical detail, followed by customized printing and packaging and the organization of transport.selection of raw materials. All that allows Proel be at the forefront in the international market.*



MATERIALS

CABLES IN REEL

• Il rame utilizzato, prodotto basilare per tutti i processi produttivi, è puro al 99,95% ed è completamente privo di ossigeno (O.F.C.). Il processo di trafilatura viene realizzato direttamente in sede di produzione per ottenere le dimensioni necessarie dei fili che vengono poi utilizzati nella trefolatura dei conduttori per raggiungere le varie sezioni utilizzate.

A questo si aggiungono gli altri materiali, tutti di primissima qualità, utilizzati per l'isolamento dei conduttori e la realizzazione delle guaine, come gomme termoplastiche reticolate, PVC, PUR, FEP, XLPE polipropilene, politene espanso, compound halogen free, compound resistenti alla fiamma, a bassa emissione di fumi e gas tossici, privi di gas corrosivi.

• *The copper used, basic product for all the production processes, has a purity of 99.95% and it is completely oxygen-free (O.F.C.). The drawing process is realized directly in the manufacturing site to obtain the required dimensions of the wires which are then used in the stranding of conductors to reach the various sections used.*

To this are added other materials, all of the highest quality, used for the conductors insulation and the realization of the sleeves, as crosslinked thermoplastic rubber, PVC, PUR, FEP, XLPE polypropylene, foamed polyethylene, halogen free and flame retardant compounds, having low emission of smoke and toxic gases, free of corrosive gases.

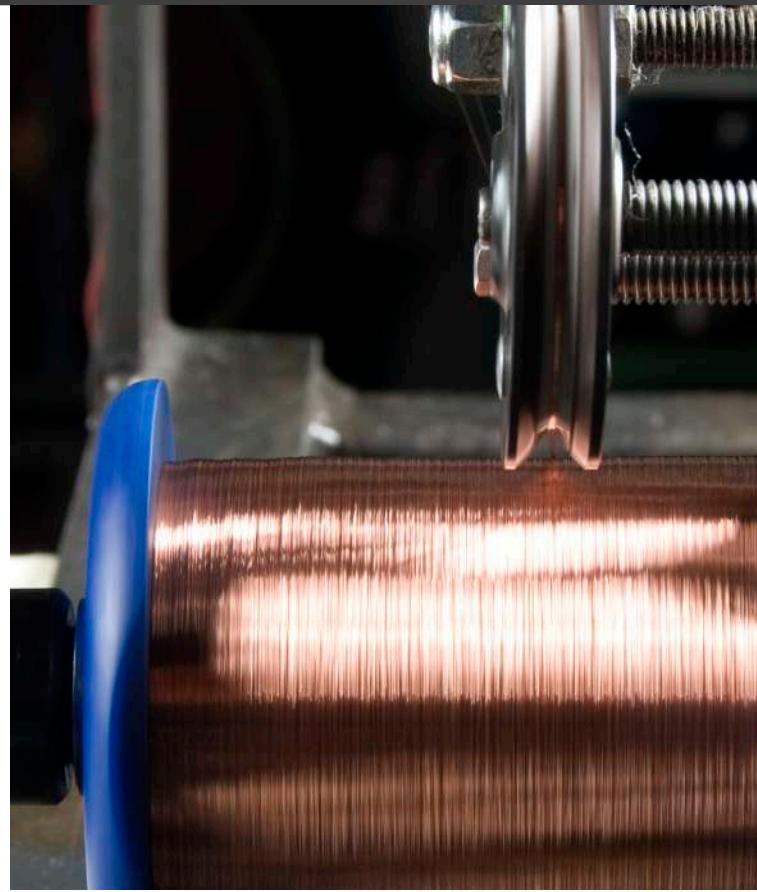

PRODUCTS CONTROL

• Tutte le prove elettriche e meccaniche rispondono alle norme tecniche applicabili nel pieno rispetto delle direttive Cee. Proel è in grado inoltre di offrire prodotti rispondenti alle normative UL e CSA. Tutti i materiali utilizzati rispondono alla direttiva RoHS (Restriction on Hazardous Substances) che prevede divieto e/o limitazioni di utilizzo per particolari sostanze pericolose quali il piombo (Pb), il mercurio (Hg), il cromo esavalente (Cr-Hex), il Cadmio (Cd), i bifenilipolibromurati (PBB) ed eteri di difenile polibromurati (PBDE). Inoltre, le aziende di produzione, sono tutte adeguate alla regolamentazione della normativa R.E.A.C.H. (Registration, Evaluation and Authorization of Chemicals), che racchiude nuovi standard di valutazione e registrazione delle sostanze chimiche utilizzate in produzione.

Oltre a tutti questi requisiti, Proel ha anche un occhio molto attento al rispetto dell'ambiente, utilizzando materiali riciclabili per tutte le tipologie di imballi.

• *All electrical and mechanical tests meet the applicable technical standards in full compliance with EEC directives. Proel is also able to offer products that meet UL and CSA standards. All the used materials comply with RoHS (Restriction on Hazardous Substances), which prohibits the use and/or limitations for particular hazardous substances such as lead (Pb), mercury (Hg), hexavalent chromium (Cr-Hex), cadmium (Cd), polybrominated biphenyls (PBB) and polybrominated diphenyl ethers (PBDEs). In addition, the production companies are all adequate to the REACH regulation (Registration, Evaluation and Authorisation of Chemicals), which includes new standards for evaluation and registration of chemicals used in production. Besides all these requirements, Proel also has a keen eye on the environment, using recyclable materials for all types of packaging.*

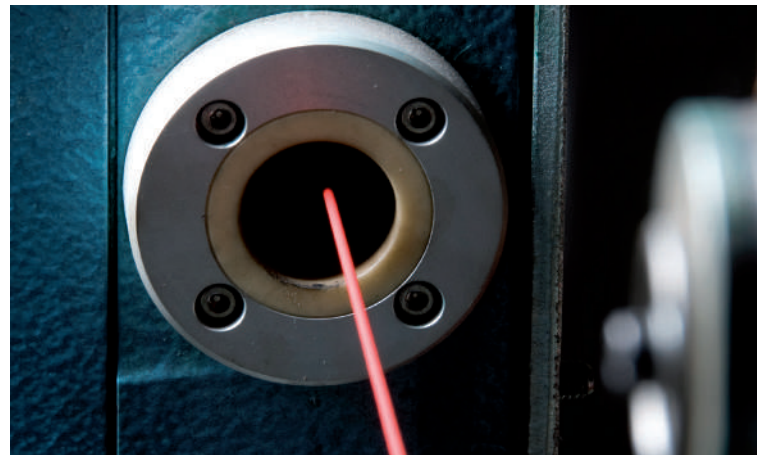

MAIN CABLE PARAMETERS

CABLES IN REEL

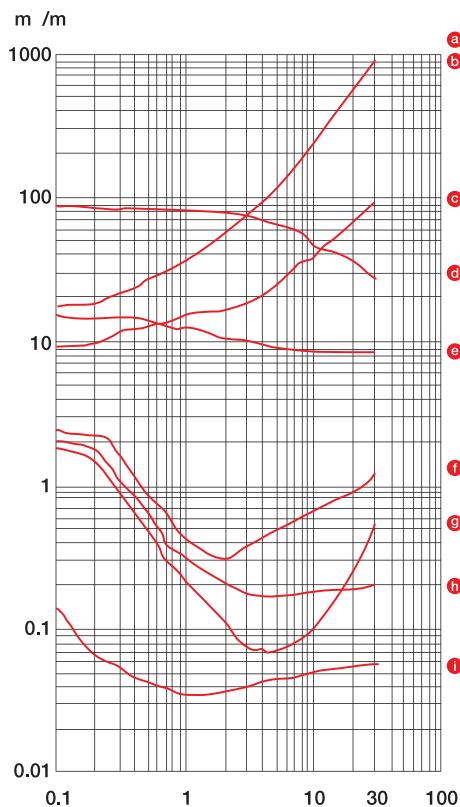

A) SPIRALE RAME 90%

B) TRECCIA DI RAME 75%

C) TRECCIA DI RAME 90%

D) ALLUMINIO/POLIESTERE

E) ALLUMINIO/POLIESTERE + TRECCIA DI RAME 95%

F) DOPPIA TRECCIA DI RAME 95% SENZA SEPARAZIONE

G) TRECCIA DI RAME 95% + NASTRO SEPARATORE + TRECCIA DI RAME 95%

H) TRECCIA DI RAME 95% + ALLUMINIO/POLIESTERE + TRECCIA DI RAME 95%

I) TRECCIA DI RAME 95% + MOMETAL + TRECCIA DI RAME 95%

A) COPPER SPIRAL 90%

B) COPPER BRAID 75%

C) COPPER BRAID 90%

D) ALUMINIUM/POLYESTER

E) ALUMINIUM/POLYESTER + COPPER BRAID 95%

F) DOUBLE COPPER BRAID 95% WITHOUT SEPARATION

G) COPPER BRAID 95% + SEPARATING TAPE + COPPER BRAID 95%

H) COPPER BRAID 95% + ALUMINIUM/POLYESTER COPPER BRAID 95% + ALUMINIUM/POLYESTER

I) COPPER BRAID 95% + MOMETAL + COPPER BRAID 95%

A) ESPIRAL COBRE 90%

B) MALLA COBRE 75%

C) MALLA COBRE 90%

D) ALUMINIO/POLIESTER

E) ALUMINIO/POLIESTER + MALLA COBRE 65%

F) DOBLE MALLA DE COBRE 95% SIN SEPARACION

G) MALLA DE COBRE 95% +CINTA SEPARADORA + MALLA DE COBRE 95%

H) MALLA DE COBRE 95% + ALUMINIO/POLIESTER + MALLA DE COBRE 95%

I) MALLA COBRE 95% + MOMETAL + MALLA COBRE 95%

ELECTRICAL PARAMETERS

RESISTENZA (Misurata in Ohm/unità di lunghezza @ 20°C).

La resistenza del conduttore è di primaria importanza per la determinazione della capacità di trasporto del segnale sulla linea di trasmissione. Più alta è la resistenza più il segnale trasmesso perderà la propria forza e quindi la capacità di arrivare a destinazione. Il suo valore è dato dal rapporto fra la resistività del materiale conduttore e la sua sezione.

CAPACITÀ (Misurata in Farad/unità di lunghezza).

La capacità esprime la propensione di un materiale dielettrico, posto fra due conduttori, di conservare la carica dielettrica quando esiste una differenza di potenziale fra i due conduttori stessi. E' sempre preferibile utilizzare cavi con bassa capacità, per permettere trasmissioni su distanze più lunghe.

IMPEDENZA CARATTERISTICA (Misurata in Ohm).

Il valore di impedenza indica l'opposizione complessiva al flusso degli elettroni offerta da una linea di trasmissione. In un sistema di trasmissione a lunga distanza o in alta frequenza, le componenti più importanti per l'impedenza sono: (a) la corrispondenza tra l'impedenza del cavo e quella del sistema ricevente (per evitare la riflessione e distorsione del segnale); (b) l'uniformità dell'impedenza (legata alla qualità del conduttore, alla geometria del cavo e all'uniformità del dielettrico).

ATTENUAZIONE (Misurata in Decibel/unità di lunghezza).

L'attenuazione determina il livello di trasmissione di una linea (normalmente il rapporto fra la tensione di entrata e quella di uscita). L'attenuazione di un segnale si risolve in una degradazione e distorsione dello stesso, con una perdita nel picco di voltaggio e rallentamento dell'impulso.

VELOCITÀ DI PROPAGAZIONE (Misurata in Percentuale).

La velocità di propagazione è il tempo richiesto da un segnale per viaggiare attraverso una linea di trasmissione. Con "Vp" si intende il rapporto fra le velocità del segnale nel suo mezzo di trasporto (isolamento) e la velocità dello stesso nell'aria, espresso in percentuale (valore in funzione della costante dielettrica del materiale dell'isolamento).

TENSIONE DI LAVORO (Misurata in Volt).

La tensione di lavoro di un cavo è limitata dal riscaldamento dello stesso e dalla temperatura di rammollimento del dielettrico. La potenza trasmissibile dipende dai materiali e dalle dimensioni del cavo oltre, naturalmente, alla temperatura ambiente.

RESISTANCE (Measured in Ohm/length unit @ 20°C).

The conductor resistance is of utmost importance for the determination of the signal's capacity of transfer on the line of transmission. The higher is the resistance the more the transmitted signal will lose its strength and as a consequence the ability to arrive at destination. Its value is given by the conductor's material resistivity vs. its section.

CAPACITANCE (Measured in Farad/length unit).

The capacity expresses the tendency of a dielectric material between conductors to store dielectric energy when a difference of potential exists between the conductors. It is always better to use low capacitance cables in order to allow transmissions over longer distances.

NOMINAL IMPEDANCE (Measured in Ohm).

The impedance value indicates the total opposition that a transmission line offers to the flow of any varying current. In a long distance or high frequency transmission system, the most important components for impedance are: (a) correspondence between cable impedance and receiving system impedance (to avoid the signal's reflection and distortion); (b) impedance uniformity (linked to conductor quality, cable geometry and dielectric uniformity).

ATTENUATION (Measured in Decibels/length unit).

The attenuation determines the transmission level of a line (usually input voltage vs. output voltage). The signal's attenuation turns into a decrease and a distortion of the signal with a loss in the voltage peak and an impulse slowing.

VELOCITY OF PROPAGATION (Measured in percentage).

The velocity of propagation is the time required by a signal to travel through a transmission line. "Vp" indicates the transmission speed of electrical energy in a length of cable compared to speed of light in free space and it is expressed as a percentage (insulation material dielectric constant dependant value).

WORKING TENSION (Measured in Volts).

The working tension of a cable is limited by its heating and by the dielectric softening temperature. The transferable power depends on materials and on cable dimensions as well as, of course, room temperature.

HIGH QUALITY MULTICORE CABLES

CABLES IN REEL



HIGH QUALITY MULTICORE AES/EBU AUDIO CABLES "CMD" SERIES

CABLES IN REEL

CMD SERIES

• I grandi sistemi audio digitali sono apparecchiature ad alta tecnologia che richiedono l'uso di connessioni multiple. Il cavo digitale audio multicoppia PROEL è conforme agli standards AES/EBU. La bassa capacità delle coppie di conduttori isolate e twistate singolarmente, insieme all'impedenza di 110 Ohm, elimina il delay del segnale, e garantisce una trasmissione priva di errori ("bit-error") anche su lunghe distanze. Il cavo AES/EBU PROEL è fornito di filo di drenaggio per la singola coppia di conduttori. Grazie a queste caratteristiche, il cavo è indicato per tutte le applicazioni che necessitano di lunghe distanze di cablaggio (lunghezza massima senza decadimento di prestazioni: 130 m).

Caratteristica della coppia:

Ogni coppia è schermata in alluminio e rivestita singolarmente in PVC nero con numerazione stampata su entrambe le facce. L'isolamento del conduttore è in polietilene espanso bianco/blue.

• *Big digital audio systems are made of high technology equipment requiring the use of multiple connections. PROEL multipair digital audio cable is compliant with AES/EBU standards. The low capacitance of insulated and individually twisted pairs of conductors, as well as the 110 Ohm impedance, eliminates signal delay and grants a bit-error free transmission, even over long distances. PROEL AES/EBU cable features drain wire for single pair of conductors. Thanks to these features, the cable is suitable for all applications requiring long distance wiring (max. length without performance decay: 130 m).*

Pair features:

Each pair is individually insulated with Aluminium foil Shield and PVC jacket, and number-printed on both sides. The conductor insulation is of white/blue foamed polyethylene.



CMD

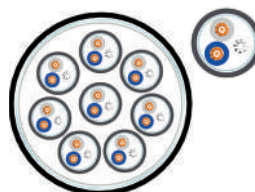

CMD SERIES

| | | | |
|-------------------------------|---|--------------------------------|---|
| Application fields | - Digital audio transmissions - Recording studio fixed installation - Stage boxes | Electrical resistance | < 86 Ohm/Km (conductor) @ 20°C |
| Conductors | Flexible tinned copper 24 AWG = 28 x 0.10 mm (0.22 mm ²) | Electrical capacitance | 37 pF/m (conductor/conductor) @ 1KHz 57 pF/m (conductor/Shield) @ 1KHz |
| Insulation | Foam PEE Ø 1.20 mm | Nominal impedance | 110 Ohm |
| Shield | PAIRS Aluminium foil 100% CABLE Cotton tape | Crosstalk Attenuation | 10 MHz = > 50 dB/100 m 15 KHz = > 100 dB/100 m |
| Jacket | PAIRS: Black PVC Ø 3.00 mm numbered CABLE: super flexible PVC | Velocity of Propagation | 80 % |
| Drain Wire (each pair) | Tinned copper 24 AWG = 7 x 0.18 mm (0.22 mm ²) | Operating temperature | -30°C / +70°C |
| Colour | Black | Working tension | < 50 V AC < 75 V DC |
| | | Minimum bending radius | 12 x overall diameter |
| | | Packaging | custom packaging |

| ORDER CODE | NUMBER OF PAIRS | OUTER DIAMETER | WEIGHT | STANDARD REEL LENGHT | MAX REEL LENGHT |
|------------|-----------------|----------------|-----------|----------------------|-----------------|
| CMD02 | 2 | Ø 8.60 mm | 67 Kg/Km | 100 m | 1000 |
| CMD04 | 4 | Ø 10.00 mm | 102 Kg/Km | 100 m | 1000 |
| CMD08 | 8 | Ø 13.40 mm | 183 Kg/Km | 100 m | 1000 |

HIGH QUALITY MULTICORE AUDIO CABLES "CMT" SERIES

CABLES IN REEL

CMT SERIES

• La serie di cavi multipolari CMT si compone di coppie isolate e schermate al 100%, numerate singolarmente e colorate per essere facilmente identificate al fine di ridurre i tempi di connessione e prevenire costosi errori di "phasing". La guaina esterna in PVC antiabrasivo fornisce una buona flessibilità anche alle più elevate temperature. L'estrema flessibilità del cavo consente un riavvolgimento facilitato.

Caratteristica della coppia:

Ogni coppia è singolarmente schermata in rame rosso e rivestita in PVC colorato a seconda degli standard internazionali con numerazione stampata su entrambe le facce. L'isolamento del conduttore è in polietilene reticolato.

• The CMT series of multicore cables consists of 100% insulated and Shielded pairs, individually numbered and coloured to allow an easy identification in order to reduce connection time and prevent expensive phasing errors. The non-abrasive PVC overall jacket offers a good flexibility even at very high temperatures. The cable extreme flexibility allows an easy winding.

Pair features:

Each pair is individually Shielded with bare copper and insulated with PVC jacket, coloured according to international regulations and number-printed on both sides. The conductor insulation is made of cross-linked polyethylene.



CMT40

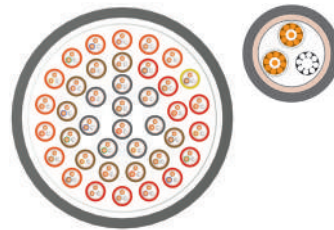

CMT SERIES

| | | | |
|-------------------------------|--|--------------------------------|--|
| Application fields | <ul style="list-style-type: none"> • Live events monitoring • Recording Studio fixed installation • Stage Boxes | Electrical capacitance | 52 pF/m (conductor/conductor) @ 1KHz 89 pF/m (conductor-Shield) @ 1KHz |
| Conductors | Flexible bare copper 26 AWG = 18 x 0.10 mm (0.14 mm ²) | Nominal impedance | 100 Ohm ± 3 Ohm |
| Insulation | XLPE Ø 1.05 mm | Attenuation | 1 MHz = 2.20 dB/100 m 3 MHz = 3.70 dB/100 m 6 MHz = 5.30 dB/100 m 8 MHz = 6.10 dB/100 m 10 MHz = 6.80 dB/100 m |
| Shield | PAIRS Spiral bare copper 97% CABLE Cotton tape 100% Tinned copper braid 85% | Velocity of Propagation | 66 % |
| Jacket | PAIRS: PVC Ø 2.80 mm numbered CABLE: PVC | Operating temperature | -20°C/+80°C |
| Drine Wire (each pair) | Tinned copper 24 AWG = 7 x 0.18 mm (0.22 mm ²) | Working tension | < 50 V AC < 75 V DC |
| Colour | Black | Minimum bending radius | 15 x overall diameter |
| Electrical resistance | 127 Ohm/Km (conductor) @ 20°C 43 Ohm/Km (Shield) @ 20°C | Packaging | custom packaging |

| ORDER CODE | NUMBER OF PAIRS | OUTER DIAMETER | WEIGHT | STANDARD REEL LENGHT | MAX REEL LENGHT |
|------------|-----------------|----------------|------------|----------------------|-----------------|
| CMT2 | 2 | Ø 8.40 mm | 88 Kg/Km | 100 m | 250 |
| CMT4 | 4 | Ø 10.60 mm | 145 Kg/Km | 100 m | 250 |
| CMT8 | 8 | Ø 13.40 mm | 230 Kg/Km | 100 m | 250 |
| CMT12 | 12 | Ø 15.10 mm | 310 Kg/Km | 100 m | 250 |
| CMT16 | 16 | Ø 16.50 mm | 389 Kg/Km | 100 m | 250 |
| CMT24 | 24 | Ø 21.60 mm | 587 Kg/Km | 100 m | 250 |
| CMT32 | 32 | Ø 23.90 mm | 739 Kg/Km | 50 m | 150 |
| CMT40 | 40 | Ø 28.30 mm | 953 Kg/Km | 50 m | 150 |
| CMT48 | 48 | Ø 29.50 mm | 1165 Kg/Km | 50 m | 150 |

HIGH QUALITY MULTICORE AUDIO CABLES "CMI" SERIES

CABLES IN REEL

CMI SERIES

• La serie di cavi multipolari CMI si compone di coppie schermate al 100% (due conduttori isolati e twistati assieme al filo di drenaggio garantendo una totale protezione dagli effetti di cross-talk), numerate singolarmente, per essere facilmente identificate (riducendo così i tempi di connessione). La guaina esterna è realizzata in PVC ad alta resistenza che evita abrasioni durante l'uso ed inoltre è conforme alle norme CEI 20-35 / IEC 332.1 (non propagante la fiamma). Inoltre essa fornisce una buona flessibilità anche alle più elevate temperature. L'estrema flessibilità del cavo consente un riavvolgimento facilitato.

Caratteristica della coppia:

Ogni coppia è schermata in alluminio e rivestita singolarmente in PVC nero con numerazione stampata su entrambe le facce. L'isolamento del conduttore è in polietilene reticolato rosso/nero.

The CMI series of multicore cables consists of 100% Shielded pairs (two insulated conductors twisted together with drain wire in order to grant a total protection against crosstalk effects), individually number-printed to allow an easy identification (therefore reducing connection time). Overall jacket is made by flexible flame retardant PVC complying with CEI 20-35 and IEC 332.1 regulations; it offers a good flexibility even at very high temperatures. The cable extreme flexibility allows an easy winding.

Pair features:

Each pair is individually insulated with Aluminium foil Shield and PVC jacket, and number-printed on both sides. The conductor insulation is of red/black cross-linked polyethylene.



CMI24

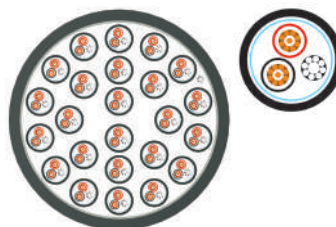

| CMI SERIES | |
|--------------------------------|--|
| Application fields | <ul style="list-style-type: none"> • Live events monitoring • Stage Boxes |
| Conductors | Bare copper 24 AWG = 28 x 0.10 mm (0.22 mm ²) |
| Insulation | XLPE Ø 1 mm |
| Shield | CONDUCTORS Aluminium-Mylard 100% CABLE Cotton tape 100% |
| Jacket | PAIRS PVC Ø 2.80 mm CABLE PVC 70 shore |
| Drine Wire (each pair) | Tinned copper 24 AWG = 7 x 0.18 mm (0.22 mm ²) |
| Colour | Black |
| Electrical resistance | < 87 Ohm/Km (conductor) @ 20°C |
| Electrical capacitance | 63 pF/m (conductor/conductor) @ 1 KHz 107 pF/m (conductor/Shield) @ 1 KHz |
| Nominal impedance | 80 Ohm ± 3 Ohm |
| Attenuation | 1 MHz = 2.10 dB/100 m 3 MHz = 3.60 dB/100 m 6 MHz = 5.00 dB/100 m 8 MHz = 5.80 dB/100 m 10 MHz = 6.50 dB/100 m |
| Velocity of Propagation | 66 % |
| Operating temperature | -20°C/+80°C |
| Working tension | < 50 V AC < 75 V DC |
| Packaging | custom packaging |

| ORDER CODE | NUMBER OF PAIRS | OUTER DIAMETER | WEIGHT | MINIMUM BENDING RADIUS | STANDARD REEL LENGHT | MAX REEL LENGHT |
|------------|-----------------|----------------|-----------|------------------------|----------------------|-----------------|
| CMI4 | 4 | Ø 9.30 mm | 94 Kg/Km | 18 x overall diameter | 100 m | 250 |
| CMI8 | 8 | Ø 12.20 mm | 164 Kg/Km | 18 x overall diameter | 100 m | 250 |
| CMI12 | 12 | Ø 14.80 mm | 223 Kg/Km | 18 x overall diameter | 100 m | 250 |
| CMI16 | 16 | Ø 16.60 mm | 316 Kg/Km | 25 x overall diameter | 100 m | 250 |
| CMI24 | 24 | Ø 19.60 mm | 440 Kg/Km | 25 x overall diameter | 100 m | 250 |
| CMI32 | 32 | Ø 22.60 mm | 581 Kg/Km | 25 x overall diameter | 100 m | 150 |

HIGH QUALITY MULTICORE AUDIO CABLES "CMN" SERIES

CABLES IN REEL

CMN SERIES

• La serie di cavi multipolari CMN si compone di coppie schermate al 100% individualmente rivestite in polipropilene trasparente numerato (due conduttori con isolante in XLPE twistati assieme al filo di drenaggio garantendo una totale protezione dagli effetti di cross-talk). La guaina esterna in PVC è realizzata in conformità agli standard CEI 20.20II e IEC 332.1 (guaina non propagante l'incendio). Inoltre essa fornisce una buona flessibilità anche alle più elevate temperature. L'estrema flessibilità del cavo consente un riavvolgimento facilitato.

Caratteristica della coppia:

Ogni coppia è rivestita singolarmente in polipropilene trasparente numerato. Lo schermo è realizzato con foglio di alluminio e filo di drenaggio. L'isolamento del conduttore è in XLPE bianco/rosso.

• The CMN series of multicore cables consists of 100% Shielded pairs individually insulated with number-printed transparent polypropylene (two XLPE jacket insulated conductors twisted together with drain wire in order to grant a total protection against crosstalk effects). The PVC overall jacket is made in accordance with CEI 20.20II and IEC 332.1 regulations (flame retardant jacket). Moreover, it offers a good flexibility even at very high temperatures. The cable extreme flexibility allows an easy winding.

Pair features:

Each pair is individually insulated with number-printed transparent polypropylene. Two XLPE (red/white) jacket insulated conductors twisted together with drain wire.



CMN20

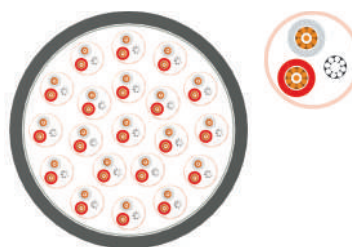

CMN SERIES

| | | | |
|-------------------------------|--|--------------------------------|--|
| Application fields | <ul style="list-style-type: none"> • Live events monitoring • Stage boxes • Recording studios | Electrical resistance | 127 Ohm/Km (conductor) @ 20°C 99 Ohm/Km (Shield) @ 20°C |
| Conductors | Bare copper 26 AWG = 18 x 0.10 mm (0.14 mm ²) | Electrical capacitance | 52 pF/m (conductor-conductor) @ 1 KHz 89 pF/m (conductor-Shield) @ 1 KHz |
| Insulation | XLPE Ø 1 mm white/red | Nominal impedance | 100 ± 3 Ohm |
| Shield | CONDUCTORS Aluminium foil copper colour 100% CABLE Cotton tape 100% | Attenuation | 1 MHz = 2.20 dB/100 m 3 MHz = 3.90 dB/100 m 6 MHz = 5.50 dB/100 m 8 MHz = 6.40 dB/100 m 10 MHz = 7.10 dB/100 m |
| Jacket | PAIRS Number-printed transparent PP Ø 2.80 mm CABLE Flexible PVC 60 shore | Velocity of Propagation | 66 % |
| Drine Wire (each pair) | Tinned copper 24 AWG = 7 x 0.18 mm (0.22 mm ²) | Operating temperature | -20°C/+80°C |
| Colour | Black | Working tension | < 50 V AC < 75 V DC |
| | | Minimum bending radius | 10 x overall diameter |
| | | Packaging | custom packaging |

| ORDER CODE | NUMBER OF PAIRS | OUTER DIAMETER | WEIGHT | STANDARD REEL LENGHT | MAX REEL LENGHT |
|------------|-----------------|----------------|-----------|----------------------|-----------------|
| CMN8 | 8 | Ø 9.70 mm | 136 Kg/Km | 100 m | 250 |
| CMN12 | 12 | Ø 11.90 mm | 161 Kg/Km | 100 m | 250 |
| CMN16 | 16 | Ø 13.20 mm | 198 Kg/Km | 100 m | 250 |
| CMN20 | 20 | Ø 14.40 mm | 242 Kg/Km | 100 m | 250 |
| CMN24 | 24 | Ø 15.00 mm | 279 Kg/Km | 100 m | 250 |
| CMN32 | 32 | Ø 18.10 mm | 371 Kg/Km | 50 m | 150 |
| CMN40 | 40 | Ø 21.60 mm | 480 Kg/Km | 50 m | 150 |
| CMN48 | 48 | Ø 22.30 mm | 530 Kg/Km | 50 m | 150 |

HIGH QUALITY AUDIO/VIDEO COAXIAL CABLES

CABLES IN REEL

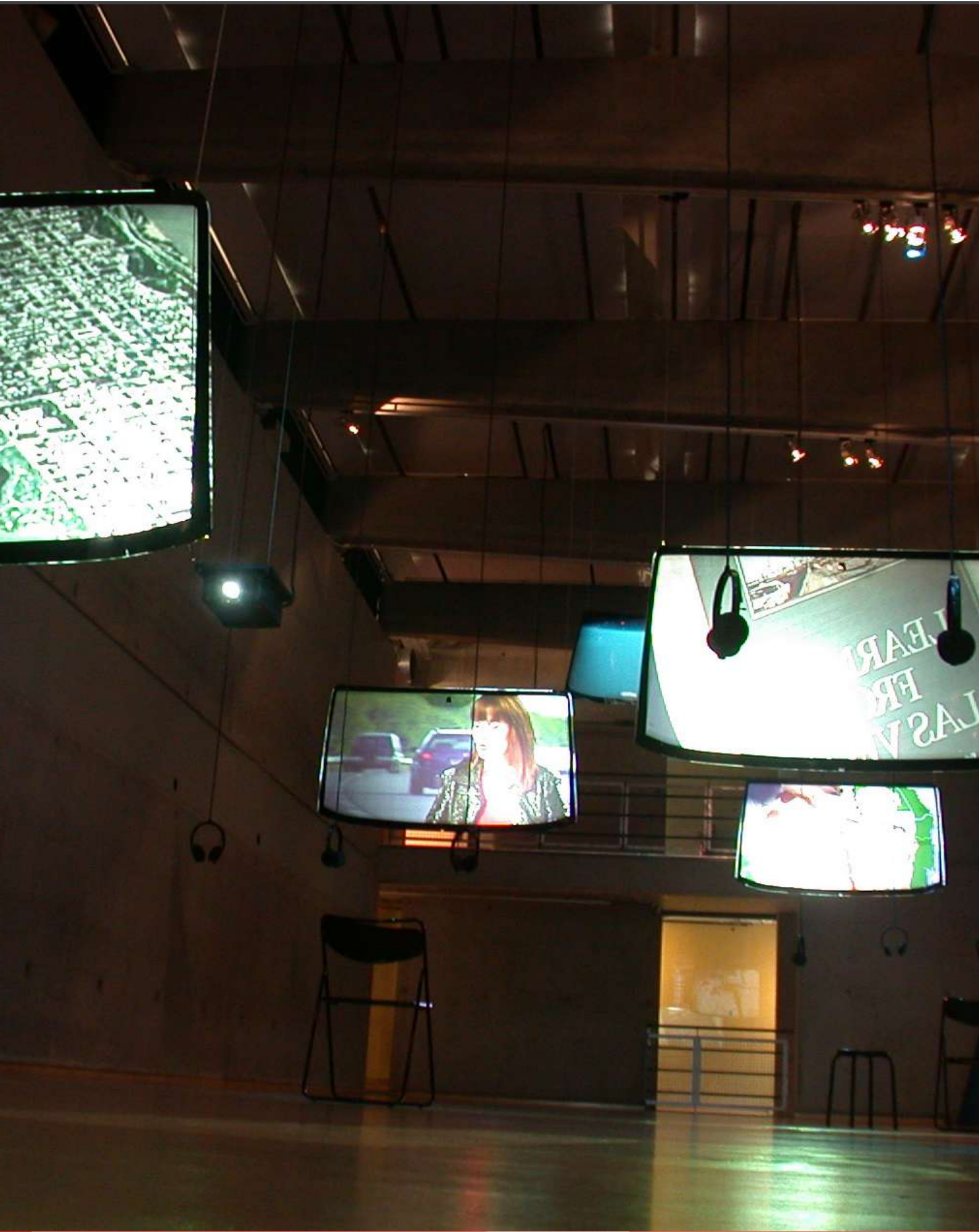

COAXIAL CABLES

CABLES IN REEL

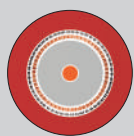

RG59 75Ω COAXIAL VIDEO CABLES

• I cavi RG59 75 Ohm hanno una doppia schermatura, e sono specifici per quelle applicazioni che esigono integrità di segnale, nitidezza, attenuazione d'impedenza e flessibilità, come nei circuiti video analogici e negli studi di trasmissione. Rappresentano la soluzione ideale per i collegamenti d'antenna e per l'interconnessione di apparecchiature video professionali.

• *RG59 75 Ohm cables feature a double Shielding and they are especially designed for those applications requiring signal integrity, sharpness, impedance attenuation and flexibility, such as in analogic video circuits and in broadcasting studios. They represent the ideal solution for aerial connections and for professional video equipment interconnection.*

HPC805

- Cavo video RG59 75 Ohm a doppia schermatura (rame rosso - rame stagnato) con guaina in PVC.
- *RG59 75 Ohm double Shielded (bare copper - tinned copper) cable with PVC jacket.*

HPC800

| | | | |
|-------------------------------|---|--------------------------------|--|
| Application fields | <ul style="list-style-type: none"> • Digital video transmissions • Camera, TV, DVD connections • Patch bay video interconnections • BNC connections | Nominal impedance | 75 Ohm ± 5 |
| Conductors | Electrolytic bare copper 22 AWG = 1 x 0.60 mm (0.32 mm ²) | Attenuation | 10 MHz = 3.10 dB/100 mt 50 MHz = 6.50 dB/100 mt 100 MHz = 10.25 dB/100 mt 200 MHz = 14.71 dB/100 mt |
| Insulation | PE Ø 3.70 mm ± 0.05 mm | Velocity of Propagation | 66 % |
| Shield | Copper/Tinned copper double braid 90% | Operating temperature | -20°C/+80°C |
| Jacket | PVC Ø 6.10 mm ± 0.20 mm Complying with IEC 332.1 | Weight | 56 Kg/Km |
| Colour | Red RAL3000 | Minimum bending radius | 30 mm |
| Electrical resistance | < 63 Ohm/Km (conductor) @ 20°C < 6.1 Ohm/Km (Shield) @ 20°C | Additional notes | Return loss: > 30 dB @ 300-600 Mhz |
| Electrical capacitance | 55 pF/m (conductor/conductor) @ 1 KHz | Packaging | 100 m carton reel |



RX75 CABLE

• Il cavo coassiale video digitale PROEL è realizzato con una doppia schermatura, con dielettrico in PE e guaina LSZH. Il suo diametro estremamente ridotto lo rende idoneo per i cablaggi di apparecchiature a rack e di patch bay video. Il cavo coassiale video digitale PROEL è particolarmente indicato per le trasmissioni video ad alte frequenze.

• *This PROEL coaxial digital video cable is made with a double Shielding, 100% PE dielectric and LSZH overall jacket. Its extremely small diameter makes it suitable for rack equipment and patch bay video wiring. PROEL coaxial digital video cable is especially suggested for high-frequency video transmissions.*

HPC820

- Cavo video digitale RG59 75 Ohm a doppia schermatura (alluminio - rame stagnato) con guaina flessibile.
- *RG59 75 Ohm digital video double Shielded (aluminium - tinned copper) cable with flexible jacket.*

HPC820

| | | | |
|------------------------------|--|--------------------------------|---------------------------------------|
| Application fields | <ul style="list-style-type: none"> • Digital video transmissions • Camera, TV, DVD connections • Patch bay, rack system interconnections • BNC and RCA connections | Electrical capacitance | 55 pF/m (conductor/conductor) @ 1 KHz |
| Conductors | Electrolytic bare copper 22 AWG = 1 x 0.60 mm (0.32 mm ²) | Nominal impedance | 75 Ohm ± 3 |
| Insulation | PEE Ø 2.30 mm ± 0.05 mm | Attenuation | 10 MHz = 5.20 dB/100 m |
| Shield | Aluminium-polyester-aluminium Tinned copper braid 90% | Velocity of Propagation | 80 % |
| Jacket | PVC/LSZH Ø 4.50 mm ± 0.15 mm Complying with IEC 754.1 regulations | Operating temperature | -20°C/+80°C |
| Colour | Purple | Weight | 31 Kg/Km |
| Electrical resistance | > 63 Ohm/Km (conductor) @ 20°C | Minimum bending radius | 25 mm |
| | | Packaging | 100 m carton reel |

COAXIAL CABLES

CABLES IN REEL

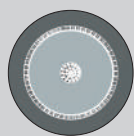

RG58 75Ω COAXIAL VIDEO/RF CABLE

• Cavo Audio-Video coassiale a singola schermatura con conduttore interno interamente in rame stagnato per offrire una stabilità dell'impedenza (50 ohm), e quindi una contenuta RL. La schermatura è realizzata a treccia di rame stagnato per conferire alto potere schermante, sia alle alte che basse frequenze. La guaina di rivestimento esterno è realizzata in PVC. Il cavo HPC858 è particolarmente indicato per la distribuzione per i segnali RF.

• Coaxial audio/video single Shielded cable with total tinned copper inner conductor to offer impedance stability (50 Ohm) and therefore a contained RL. The Shielding is made of tinned copper braid conferring a high Shielding capacity to the cable, both at high and low frequencies. The overall jacket is made of PVC. The HPC858 cable is especially recommended for RF signals distribution.

HPC858

- Cavo audio-video a singola schermatura RG58.
- RG58 audio/video single Shielded cable.

| HPC858 | |
|--------------------------------|---|
| Application fields | <ul style="list-style-type: none"> • RF signals • Ethernet signals • TV device interconnections • BNC and RCA connections |
| Conductors | Tinned copper 21 AWG = 19 x 0.18 mm (0.41 mm ²) |
| Insulation | PE Ø 2.95 mm ± 0.05 mm |
| Shield | Tinned copper braid 95% |
| Jacket | PVC Ø 5.00 mm |
| Colour | Black |
| Electrical resistance | 38 Ohm/Km (conductor) @ 20°C 14 Ohm/Km (Shield) @ 20°C |
| Electrical capacitance | 97 pF/m (conductor/conductor) @ 1KHz |
| Nominal impedance | 50 Ohm |
| Attenuation | 100 MHz = 14.70 dB/100 m 200 MHz = 20.80 dB/100 m 1000 MHz = 57 dB/100 m |
| Velocity of Propagation | 66 % |
| Operating temperature | -20°C/+80°C |
| Weight | 40 Kg/Km |
| Minimum bending radius | 30 mm |
| Packaging | 100 m carton reel |

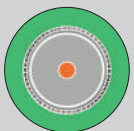

RG6 75Ω HALOGEN FREE COAXIAL VIDEO CABLE

• Cavo Audio-Video digitale a doppia schermatura con conduttore interno interamente in rame e dielettrico Skin-Foam-Skin atto a garantire una elevata stabilità d'impedenza (75 Ohm) ed un contenuto RL. La schermatura è di tipo misto: calza in rame stagnato e Foil in alluminio per conferire al cavo un alto potere schermante, sia alle alte che basse frequenze. La guaina di rivestimento esterno è realizzata con un compound halogen free, molto resistente alle alte temperature, assolutamente richiesto per le installazioni in posa fissa.

• Digital audio/video double Shielded cable with total copper inner conductor and Skin-Foam-Skin dielectric to ensure high impedance stability (75 Ohm) and therefore a contained RL. The Shielding is mixed: tinned copper braid and aluminium foil that confer a high Shielding capacity to the cable, both at high and low frequencies. The overall jacket is made of halogen free compound, very resistant to high temperatures, absolutely required in fixed installations.

HPC860HF

- Cavo audio-video digitale RG6 a doppia schermatura Low Loss con guaina LSZH.
- RG6 Digital audio-video double Shielded cable - Low Loss with LSZH jacket.

| HPC860HF | |
|--------------------------------|---|
| Application fields | <ul style="list-style-type: none"> • Digital video transmissions • Camera, TV, DVD connections • Satellite device interconnections |
| Conductors | Bare copper 18 AWG = 1 x 1,02 mm (0.823 mm ²) |
| Insulation | Skin-Foam-Skin Ø 4.60 mm ± 0.10 mm |
| Shield | Aluminium/Pet/Aluminium 100% Tinned copper braid >96% |
| Jacket | LSZH Compound Ø 6.90 mm ± 0.15 mm |
| Colour | Green RAL6017 |
| Electrical resistance | 21,5 Ohm/Km (conductor) @ 20°C 9,0 Ohm/Km (Shield) @ 20°C |
| Electrical capacitance | 53 pF/m (conductor/conductor) @ 1KHz |
| Nominal impedance | 75 Ohm |
| Attenuation | 5 MHz = 1.60 dB/100 m 50 MHz = 4.60 dB/100 m 200 MHz = 8,80 dB/100 m 470 MHz = 13,80 dB/100 m |
| Velocity of Propagation | 85 % |
| Operating temperature | -20°C/+80°C |
| Working tension | < 50 V AC < 75 V DC |
| Weight | 57,5 Kg/Km |
| Minimum bending radius | 35 mm |
| Packaging | 100 m carton reel |

HIGH QUALITY INSTRUMENT CABLES

CABLES IN REEL



HIGH QUALITY NOISELESS INSTRUMENT CABLES O.F.C.

CABLES IN REEL

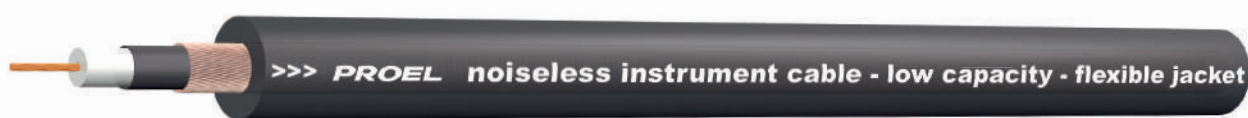

HPC110

- Cavo coassiale antirumore per strumenti/effetti con guaina esterna flessibile in PVC Ø 6.4 mm - O.F.C. (Oxygen Free Copper).
- Coaxial noiseless instrument/effects cable with Ø 6.4 mm. PVC flexible overall jacket - O.F.C. (Oxygen Free Copper).

HPC110

| | | | |
|---------------------------|--|--------------------------------|-------------------------------------|
| Application fields | • Musical instrument connection • Multieffect/mixer connection | Electrical resistance | 74 Ohm/Km (conductor) @ 20°C |
| Conductors | Bare copper 23 AWG = 30 x 0.10 mm (0.25 mm ²) | Electrical capacitance | 120 pF/m (conductor/Shield) @ 1 KHz |
| Insulation | PE Ø 1.80 mm | Velocity of Propagation | 80 % |
| Shield | CABLE Spiral Flexible copper 16x3x0.10 95% | Operating temperature | -20°C/+70°C |
| Jacket | CONDUCTOR High-conductive graphite jacket Ø 2.40 mm CABLE Flexible PVC 60 shore Ø 6.40 mm | Working tension | < 50 V AC < 75 V DC |
| Colour | Black (BK), Blue (BL), Red (RD) | Weight | 44 Kg/Km |
| | | Minimum bending radius | 20 x cable section radius |
| | | Packaging | 100 m carton reel |



HPC130

- Cavo coassiale professionale antirumore esotico per strumenti con guaina esterna antiscivolo ideale per tutte le connessioni strumentali - O.F.C. (Oxygen Free Copper).
- Professional noiseless esoteric coaxial instrument cable with non-slip overall jacket ideal for any instrumental connection - O.F.C. (Oxygen Free Copper).

HPC130

| | | | |
|------------------------------|--|--------------------------------|-------------------------------------|
| Application fields | • Musical Instrument connection • Multieffect/mixer connection | Electrical capacitance | 120p F/m (conductor/Shield) @ 1 KHz |
| Conductors | Tinned copper 18 AWG = 42 x 0.15 mm (0.75 mm ²) | Velocity of Propagation | 80 % |
| Insulation | PEE Ø 3.10 mm | Operating temperature | -20°C/+70°C |
| Shield | Tinned copper braid 8x16x0.10 90% | Working tension | < 50 V AC < 75 V DC |
| Jacket | CONDUCTOR High-conductive graphite jacket Ø 2.40 mm 100% CABLE Flexible non-slip PVC 64 shore Ø 7.00 mm | Weight | 59 Kg/Km |
| Colour | Black | Minimum bending radius | 20 x cable section radius |
| Electrical resistance | 37 Ohm/Km (conductor) @ 20°C 20 Ohm/Km (Shield) @ 20°C | Packaging | 100 m carton reel |

• Questi cavi coassiali schermati in rame puro O.F.C. sono concepiti per le connessioni di chitarre, tastiere, amplificatori, mixer, effetti a pedale e tutti i dispositivi di elaborazione di segnali audio. Bassissima capacità, guaina esterna robusta e flessibile, doppia schermatura con materiale termoplastico conduttivo e con spirale o treccia di rame molto fitta. Un isolante in spesso PE o PEE rende questi cavi ideali per tutte le applicazioni in cui possono presentarsi tensioni meccaniche del cavo (es. collegamento chitarra/amplificatore).

• These coaxial cables featuring a very thick pure copper Shield and are designed for connecting guitars, keyboards, amplifiers, mixers, effect pedals and any audio signal processing devices. Very low capacitance, strong and flexible overall jacket, double Shielding with conductive thermoplastic material and very thick upper copper spiral and/or copper braiding. A thick PE or PEE insulation makes them an ideal serie of cables for all applications liable to mechanical tensions of the cable (e.g. guitar/amplifier connection).

HIGH QUALITY NOISELESS INSTRUMENT CABLES O.F.C.

CABLES IN REEL



HPC300

- Cavo piatto a 2 conduttori singolarmente schermati con guaina esterna in PVC flessibile. Sezione: $2 \times 0,14 \text{ mm}^2$.
- 2 individually Shielded conductors ($2 \times 0,14 \text{ mm}^2$) flat cable with flexible PVC overall jacket.

HPC300

| | | | |
|------------------------------|--|-------------------------------|--|
| Application fields | • Audio connections | Electrical capacitance | 52.5 pF/m (conductor/conductor) @ 1 KHz 250 pF/m (conductor/Shield) @ 1 KHz |
| Conductors | Bare copper 25 AWG = $18 \times 0,10 \text{ mm}$ ($0,14 \text{ mm}^2$) | Operating temperature | -30°C/+70°C |
| Insulation | PVC 80 shore $\varnothing 1,00 \text{ mm}$ | Working tension | < 50 V AC |
| Shield | Spiral copper $5 \times 8 \times 0,10 > 90\%$ | Weight | 27 Kg/Km |
| Jacket | Flexible PVC 50 shore $\varnothing 3,00 \text{ mm}$ | Minimum bending radius | 20 x cable section radius |
| Colour | Black | Packaging | 100 m carton reel |
| Electrical resistance | 122.80 Ohm/Km (conductor) @ 20°C | | |

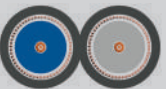

HPC305

- Cavo piatto a 2 conduttori singolarmente schermati con guaina esterna in PVC flessibile. Sezione: $2 \times 0,21 \text{ mm}^2$.
- 2 individually Shielded conductors ($2 \times 0,21 \text{ mm}^2$) flat cable with flexible PVC overall jacket.

HPC305

| | | | |
|------------------------------|--|-------------------------------|--|
| Application fields | • Audio connections | Electrical capacitance | 21.2 pF/m (conductor/conductor) @ 1 KHz 117.5 pF/m (conductor/Shield) @ 1 KHz |
| Conductors | Bare copper 23 AWG = $12 \times 0,15 \text{ mm}$ ($0,21 \text{ mm}^2$) | Operating temperature | -30°C/+70°C |
| Insulation | PE $\varnothing 1,60 \text{ mm}$ | Working tension | < 50 V AC |
| Shield | Spiral copper $4 \times 16 \times 0,10 > 90\%$ | Weight | 43 Kg/Km |
| Jacket | Flexible PVC 50 shore $\varnothing 5,00 \text{ mm}$ | Minimum bending radius | 20 x cable section radius |
| Colour | Black | Packaging | 100 m carton reel |
| Electrical resistance | 73.80 Ohm/Km (conductor) @ 20°C | | |

HIGH QUALITY MICROPHONE CABLES

CABLES IN REEL



HIGH-QUALITY STARQUAD MICROPHONE CABLE O.F.C.

CABLES IN REEL



• Il cavo PROEL QUAD420 è concepito principalmente per microfono, ma si adatta perfettamente a tutti gli altri tipi di segnali audio. I 4 conduttori del cavo QUAD420 eliminano le interferenze ed i ronzii generati dai campi elettrostatici indotti da dimmer, trasformatori di potenza e luci fluorescenti. L'eccellente frequenza di risposta è dovuta allo speciale rivestimento isolante in polietilene che fornisce una bassa capacità dielettrica. Il cavo QUAD420 ha una schermatura a spirale ad alta densità, proprio per eliminare qualunque ronzio ed interferenza radio. La guaina esterna, in morbido PVC speciale, consente un'estrema maneggevolezza e garantisce un'ottima tolleranza all'abrasione.

• PROEL QUAD420 cable is designed mainly for microphone use, but it perfectly suits any other type of audio signal. The 4 conductors of QUAD420 cable eliminate interferences and buzzes produced by dimmer electrostatic fields, power transformers and fluorescent lights. The excellent response frequency is due to the special insulating PE jacket providing low dielectric capacitance. QUAD420 cable features a high-density spiral Shielding to eliminate any buzzing and radio interference. Overall jacket is made of a special PVC, allowing an extremely easy handling and granting an excellent abrasion tolerance.

QUAD420

- Cavo per microfono "high-quality" STARQUAD a 4 conduttori twistati con guaina esterna antiabrasione antistatica - O.F.C. (Oxygen Free Copper).
- High-quality STARQUAD microphone cable, 4 twisted conductors with antiabrasive antistatic overall jacket - O.F.C. (Oxygen Free Copper).

QUAD420

| | | | |
|---------------------------|--|--------------------------------|--|
| Application fields | • Microphone connections • Audio signal connections | Electrical resistance | <86 Ohm/Km (conductor) @ 20°C |
| Conductors | Extra fine strands of bare copper 24 AWG = 28 x 0.10 mm (0.22 mm ²) | Electrical capacitance | 91 pF/m (conductor/Shield) @ 1 KHz 50 pF/m (conductor/ conductor) @ 1 KHz |
| Insulation | Polyolefin dielectric natural, blue, red, black - Ø = 1,6 mm ca | Velocity of Propagation | 80 % |
| Shield | Spiral bare copper wires coverage >95% | Operating temperature | -20°C/+80°C |
| Jacket | Soft PVC compound - Ø = 6,2 mm ca. | Weight | 46 Kg/Km |
| Drain wire | Tinned copper 24 AWG = 7 x 0.15 mm (0.22 mm ²) | Minimum bending radius | 10 x cable overall diameter |
| Colour | Black | Packaging | 100 m carton reel (other lengths on request) |

HIGH-QUALITY BALANCED MICROPHONE CABLES O.F.C.



HPC290BK

- Cavo bilanciato "high end" professionale per microfono con guaina esterna flessibile - O.F.C. (Oxygen Free Copper - Sezione 2 x 0,50 mm²) con guaina interna per stabilizzare la cordatura dei conduttori.
- High-end professional balanced microphone cable (2 x 0,50 mm²) with flexible overall jacket - O.F.C. (Oxygen Free Copper) with inner jacket for stabilizing pair twisting.

HPC290BK

| | | | |
|------------------------------|---|--------------------------------|--|
| Application fields | • Installations • Recording studios • Professional Stage connections • Microphone connections | Electrical capacitance | 55 pF/m (conductor/conductor) @ 1 KHz 120 pF/m (conductor/screen) @ 1 KHz |
| Conductors | Bare copper 20 AWG = 26 x 0.15 mm (0.50 mm ²) | Velocity of Propagation | 66% |
| Insulation | LDPE Ø 1.40 mm - PVC Ø 3.60 mm | Operating temperature | -20°C/+70°C |
| Shield | Bare copper braid 24x7x0,10 - > 90% | Working tension | < 50 V AC < 75 V DC |
| Jacket | PVC TM2 complying with EN 50363-4-1 hardness 63± 2 Sh-A Ø 7.0 mm | Weight | 57 Kg/Km |
| Colour | Black | Minimum bending radius | 15 x cable section radius |
| Electrical resistance | 39 Ohm/Km (conductor) @ 20°C 16 Ohm/Km (Shield) @ 20°C | Packaging | 100 m carton reel |

HIGH-QUALITY BALANCED MICROPHONE CABLES O.F.C.

CABLES IN REEL



HPC280

- Cavo bilanciato "high quality" - per microfono con guaina esterna flessibile - O.F.C. (Oxygen Free Copper - Sezione $2 \times 0,34 \text{ mm}^2$).
- High-quality balanced microphone cable ($2 \times 0,34 \text{ mm}^2$) with flexible overall jacket - O.F.C. (Oxygen Free Copper).

HPC280

| | | | |
|------------------------------|--|--------------------------------|---|
| Application fields | <ul style="list-style-type: none"> • Installations • Recording studios • Microphone connections | Electrical capacitance | 40 pF/m (conductor/conductor) @ 1 KHz |
| Conductors | Bare copper 22 AWG = $43 \times 0.10 \text{ mm}$ (0.34 mm^2) | Velocity of Propagation | 66 % |
| Insulation | PE \varnothing 1.50 mm | Impedance | 110 Ohm |
| Shield | Tinned copper braid > 90% | Operating temperature | -20°C/+70°C |
| Jacket | Super Flexible PVC 70 shore \varnothing 6.50 mm | Working tension | < 50 V AC < 75 V DC |
| Drain wire | Tinned copper 24 AWG = $7 \times 0.15 \text{ mm}$ (0.22 mm^2) | Weight | 57 Kg/Km |
| Colour | Black | Minimum bending radius | 15 x cable section radius |
| Electrical resistance | 56 Ohm/Km (conductor) @ 20°C 16 Ohm/Km (Shield) @ 20°C | Packaging | 100 m carton reel (other lengths on request) |



HPC250

- Cavo bilanciato "high quality" per microfono con guaina esterna flessibile - O.F.C. (Oxygen Free Copper - Sezione $2 \times 0,22 \text{ mm}^2$).
- High-quality balanced microphone cable ($2 \times 0,22 \text{ mm}^2$) with flexible overall jacket - O.F.C. (Oxygen Free Copper).

HPC250

| | | | |
|------------------------------|--|--------------------------------|---|
| Application fields | <ul style="list-style-type: none"> • Installations • Recording studios • Microphone connections | Electrical capacitance | 90 pF/m (conductor/conductor) @ 1 KHz |
| Conductors | Tinned copper 24 AWG = $7 \times 0.20 \text{ mm}$ (0.22 mm^2) | Velocity of Propagation | 80 % |
| Insulation | PE \varnothing 1.36 mm | Operating temperature | -20°C/+70°C |
| Shield | Tinned copper braid $6 \times 16 \times 0.10 \text{ mm}$ > 95% | Working tension | < 50 V AC < 75 V DC |
| Jacket | Flexible PVC 60 shore \varnothing 6.50 mm | Weight | 51 Kg/Km |
| Drain wire | Tinned copper 24 AWG = $7 \times 0.20 \text{ mm}$ (0.22 mm^2) | Minimum bending radius | 20 x cable section radius |
| Colour | Black | Packaging | 100 m carton reel (other lengths on request) |
| Electrical resistance | 93 Ohm/Km (conductor) @ 20°C 21 Ohm/Km (Shield) @ 20°C | | |

HIGH-QUALITY BALANCED MICROPHONE CABLES O.F.C.

CABLES IN REEL



HPC222BK

• Cavo bilanciato digitale - per microfono e apparati audio con guaina esterna robusta e flessibile - O.F.C. (Oxygen Free Copper - Sezione 2 x 0.22 mm²).
 • Digital balanced microphone cable (2 x 0,22 mm²) with strong and flexible overall jacket - O.F.C. (Oxygen Free Copper).

HPC220

| | | | |
|---------------------------|--|--------------------------------|---|
| Application fields | <ul style="list-style-type: none"> • Amplifiers • DMX connections • Mic-Mixer connections • Microphone connections • Speakers | Electrical capacitance | 85 pF/m (conductor/Shield) @ 1 KHz |
| Conductors | Tinned copper 24 AWG = 7 x 0.20 mm (0.22 mm ²) | Velocity of Propagation | 76 % |
| Insulation | PEE Ø 1.60 mm | Operating temperature | -20°C/+70°C |
| Shield | PET/Aluminium Tape 100% | Working tension | < 50 V AC < 75 V DC |
| Jacket | Flexible PVC 64 shore Ø 4.70 mm | Weight | 23,79 Kg/Km |
| Colour | Black | Minimum bending radius | 20 x cable section radius |
| Impedance | 110 Ohm | Packaging | 100 m carton reel 300 m wooden reel HPC222BKR300 |



HPC210

• Cavo bilanciato professionale per microfono con guaina esterna flessibile - O.F.C. (Oxygen Free Copper - Sezione 2 x 0,22 mm²).
 • Professional balanced microphone cable (2 x 0,22 mm²) with flexible overall jacket - O.F.C. (Oxygen Free Copper).

HPC210

| | | | |
|------------------------------|---|--------------------------------|---|
| Application fields | <ul style="list-style-type: none"> • Recording studios • Microphone connections | Electrical capacitance | 46 pF/m (conductor/conductor) @ 1 KHz 90 pF/m (conductor/Shield) @ 1 KHz |
| Conductors | Bare copper 24 AWG = 30 x 0.10 mm (0.22 mm ²) | Velocity of Propagation | 80 % |
| Insulation | Superflexible PVC HT105 Ø 1.60 mm | Operating temperature | -20°C/+70°C |
| Shield | CONDUCTORS Spiral cotton filler CABLE Spiral copper 16x5x0.10 mm > 90% | Working tension | < 50 V AC < 75 V DC |
| Jacket | Flexible PVC 60 shore Ø 6.50 mm | Weight | 46 Kg/Km |
| Colour | Black (BK), Blue (BL), Bronze (BZ), Green (GN), Purple (PU), Red (RD), White (WH), Yellow (YE) | Minimum bending radius | 20 x cable section radius |
| Electrical resistance | 93 Ohm/Km (conductor) @ 20°C 20 Ohm/Km (Shield) @ 20°C | Packaging | 100 m carton reel 300 m wooden reel HPC210BKR300 500 m wooden reel HPC210BKR500 |

HIGH-QUALITY BALANCED MICROPHONE CABLES O.F.C.

CABLES IN REEL



HPC201BK

- Cavo bilanciato professionale per microfono con guaina esterna robusta e flessibile - O.F.C. (Oxygen Free Copper - Sezione 2 x 0,14 mm²).
- Professional balanced coaxial microphone cable (2 x 0,14 mm²) with strong and flexible overall jacket - O.F.C. (Oxygen Free Copper).

HPC201BK

| | | | |
|------------------------------|---|--------------------------------|---|
| Application fields | • Mixer connections • Microphone connections | Electrical capacitance | 45 pF/m (conductor/conductor) @ 1 KHz 96 pF/m (conductor/Shield) @ 1 KHz |
| Conductors | Bare copper 26 AWG = 18 x 0.10 mm (0.14 mm ²) | Velocity of Propagation | 66 % |
| Insulation | PE Ø 1.25 mm | Operating temperature | -20°C/+70°C |
| Shield | Aluminium/Polyester 100% | Working tension | < 50 V AC |
| Jacket | Flexible PVC 60 shore Ø 6.00 mm | Weight | 40 Kg/Km |
| Drain wire | Tinned copper 24 AWG = 7 x 0.20 mm (0.22 mm ²) | Minimum bending radius | 20 x cable section radius |
| Colour | Black | Packaging | 100 m carton reel |
| Electrical resistance | 125 Ohm/Km (conductor) @ 20°C | | |

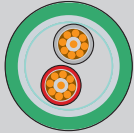

HPC210FR

- Cavo bilanciato per microfono con guaina esterna flessibile antifiama particolarmente indicato per installazioni fisse. - O.F.C. (Oxygen Free Copper) - Sezione 2 x 0,34 mm².
- Balanced microphone cable (2 x 0,34 mm²) with flexible flame resistant overall jacket particularly suitable for fixed installations - O.F.C. (Oxygen Free Copper).

HPC210FR

| | | | |
|-------------------------------|--|--------------------------------|--|
| Application fields | • Installation • Recording studios • Microphone connections | Attenuation | 1 MHz = 1.60 dB/100 m 3 MHz = 2.80 dB/100 m 6 MHz = 4.00 dB/100 m 8 MHz = 4.60 dB/100 m 10 MHz = 5.10 dB/100 m |
| Conductors | Bare copper 22 AWG = 19 x 0.15 mm (0.34 mm ²) | Velocity of Propagation | 66 % |
| Insulation | XLPE Ø 1.60 mm natural/red | Operating temperature | -20°C/+80°C |
| Shield | Aluminium foil 100% Tinned copper braid 90% | Working tension | < 50 V AC < 75 V DC |
| Jacket | Flexible flame resistant PVC Ø 5.60 mm Complying with IEC 332.2 regulations | Weight | 44 Kg/Km |
| Colour | Green RAL6017 | Minimum bending radius | 30 mm |
| Electrical resistance | < 62 Ohm/Km (conductor) @ 20°C | Packaging | 100 m carton reel 300 m wooden reel HPC210FR300 |
| Electrical capacitance | 50 pF/m (conductor/conductor) @ 1 KHz 87 pF/m (conductor/Shield) @ 1 KHz | | |
| Nominal impedance | 110 Ohm | | |

HIGH-QUALITY BALANCED MICROPHONE INSTALLATION CABLES O.F.C. CABLES IN REEL

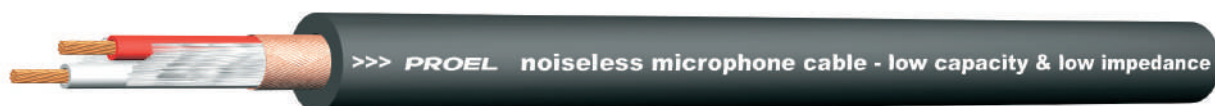

HPC210HF

• Cavo bilanciato per microfono con guaina esterna flessibile antifiama LSZH particolarmente indicato per installazioni fisse. - O.F.C. (Oxygen Free Copper) - Sezione $2 \times 0.25 \text{ mm}^2$.
• *Balanced microphone cable ($2 \times 0.25 \text{ mm}^2$) with flexible LSZH flame resistant overall jacket particularly suitable for fixed installations - O.F.C. (Oxygen Free Copper).*

HPC210HF

| | | | |
|-------------------------------|--|--------------------------------|---|
| Application fields | • Installations • Recording studios • Professional Stage connections • Microphone connections | Velocity of Propagation | 80 % |
| Conductors | Bare copper 24 AWG = $30 \times 0.10 \text{ mm}$ (0.25 mm^2) | Operating temperature | $-20^\circ\text{C}/+70^\circ\text{C}$ |
| Insulation | LDPE $\varnothing 1.60 \text{ mm}$ | Working tension | < 50 V AC < 75 V DC |
| Shield | Spiral bare copper > 70% | Weight | 46 Kg/Km |
| Jacket | Flame and fire - retardant thermoplastic material LSZH - Hardness 45 shore $\varnothing 6.30 \text{ mm}$ | Minimum bending radius | 20 x cable section radii |
| Colour | Black | Packaging | 100 m carton reel 300 m carton reel HPC210HFR300 |
| Electrical capacitance | 45 pF/m (conductor/conductor) @ 1 KHz 100 pF/m (conductor/Shield) @ 1 KHz | | |



HPC80 - HPC80WH

• Cavo coassiale bilanciato per installazione con guaina esterna schermata con nastro in alluminio - O.F.C. (Oxygen Free Copper) dal diametro ridotto - Sezione $2 \times 0.22 \text{ mm}^2$.
• *Balanced coaxial installation cable ($2 \times 0.22 \text{ mm}^2$) with small diameter aluminium foil Shielded overall jacket - O.F.C. (Oxygen Free Copper).*

HPC80

| | | | |
|-------------------------------|---|--------------------------------|--|
| Application fields | • Patch-bay connections • Multieffect connections • Rack system connections | Attenuation | 1 MHz = 2.10 dB/100 m 3 MHz = 3.60 dB/100 m 6 MHz = 5.00 dB/100 m 8 MHz = 5.80 dB/100 m 10 MHz = 6.50 dB/100 m |
| Conductors | Tinned copper 24 AWG = $7 \times 0.20 \text{ mm}$ (0.22 mm^2) | Velocity of Propagation | 66% |
| Insulation | PE $\varnothing 1.05 \text{ mm}$ | Operating temperature | $-20^\circ\text{C}/+80^\circ\text{C}$ |
| Shield | Aluminium foil 100% | Working tension | < 50 V AC < 75 V DC |
| Jacket | Flexible PVC 80 shore $\varnothing 4.00 \text{ mm}$ | Weight | 20 Kg/Km |
| Drain wire | Tinned copper 24 AWG = $7 \times 0.20 \text{ mm}$ (0.22 mm^2) | Minimum bending radius | 25 mm |
| Colour | Black | Packaging | 100 m carton reel 300 m carton reel HPC80R300 - HPC80WHR300 500 m wooden reel HPC80R500 |
| Electrical resistance | < 87 Ohm/Km (conductor) @ 20°C | | |
| Electrical capacitance | 63 pF/m (conductor/conductor) @ 1 KHz 107 pF/m (conductor/Shield) @ 1 KHz | | |
| Nominal Impedance | $80 \pm 3 \text{ Ohm}$ | | |

HIGH-QUALITY BALANCED MICROPHONE INSTALLATION CABLES O.F.C.

CABLES IN REEL



HPC90

• Cavo bilanciato digitale AES/EBU per installazione con guaina esterna schermata con nastro in alluminio e resistente alla fiamma - O.F.C. (Oxygen Free Copper) dal diametro ridotto - Sezione $2 \times 0,22 \text{ mm}^2$.
 • *Balanced AES/EBU Audio Digital cable ($2 \times 0,22 \text{ mm}^2$) small diameter aluminium foil Shielded flame resistant overall jacket. - O.F.C. (Oxygen Free Copper).*

| HPC90 | |
|--------------------------------|--|
| Application fields | <ul style="list-style-type: none"> • Patch connections, gooseneck microphones • Home recording connections • Rack and console connections |
| Conductors | Tinned copper 24 AWG = $28 \times 0,10 \text{ mm}$ ($0,22 \text{ mm}^2$) |
| Insulation | PE $\varnothing 1,20 \text{ mm}$ |
| Shield | Aluminium foil coverage 100% |
| Jacket | Flame resistant PVC 70 shore $\varnothing 3,00 \text{ mm}$ |
| Drain wire | Tinned copper 25 AWG = $7 \times 0,18 \text{ mm}$ ($0,18 \text{ mm}^2$) |
| Colour | Black |
| Electrical resistance | 87 Ohm/Km (conductor) @ 20°C |
| Electrical capacitance | 37 pF/m (conductor/conductor) @ 1 KHz 57 pF/m (conductor/Shield) @ 1 KHz |
| Nominal Impedance | 110 Ohm |
| Velocity of Propagation | 80 % |
| Operating temperature | -20°C/+70°C |
| Working tension | < 50 V AC < 75 V DC |
| Weight | 10 Kg/Km |
| Minimum bending radius | 20 x cable section radius |
| Packaging | 100 m carton reel 300 m carton reel HPC90R300 |

HIGH QUALITY BALANCED PHONO FEED CABLES O.F.C.



HPC501 - HPC502

• Cavo professionale combinato di tipo audio + alimentazione. Composto da una coppia audio bilanciata, twistata e individualmente isolata + cavo di alimentazione elettrica monofase. Guaina esterna in PVC flessibile antinfiamma. Modelli disponibili: HPC501 - Audio $2 \times 0,35 \text{ mm}^2$ + Power $3 \times 1,50 \text{ mm}^2$ / HPC502 - Audio $2 \times 0,35 \text{ mm}^2$ - Power $3 \times 2,50 \text{ mm}^2$.
 • *Professional combined phono-feed cable. Composed by an individual insulated and twisted audio pair + single phase electric power cable. Flexible flame resistant PVC overall jacket. Available models: HPC501: $2 \times 0,35 \text{ mm}^2$ Audio cable + $3 \times 1,5 \text{ mm}^2$ power conductor / HPC502: $2 \times 0,35 \text{ mm}^2$ Audio cable + $3 \times 2,5 \text{ mm}^2$ power conductor.*

| HPC501 - HPC502 | |
|-------------------------------|--|
| Application fields | • Audio connections |
| Conductors | Bare copper Power: • HPC501 16 AWG = $3 \times 29 \times 0,25 \text{ mm}$ ($1,5 \text{ mm}^2$) • HPC502 14 AWG = $3 \times 49 \times 0,25 \text{ mm}$ ($2,5 \text{ mm}^2$) Signal: 22 AWG = $2 \times 11 \times 0,20 \text{ mm}$ ($0,35 \text{ mm}^2$) |
| Insulation | Power: • HPC501 PVC 60 shore $\varnothing 3,0 \text{ mm}$ • HPC502 PVC 60 shore $\varnothing 3,6 \text{ mm}$ Signal: PVC HT105 $\varnothing 1,50 \text{ mm}$ |
| Shield | Spiral red copper $4 \times 16 \times 0,12$ 90% |
| Jacket | CONDUCTORS PVC 60 shore $\varnothing 4,00 \text{ mm}$ CABLE • HPC501 - Flexible PVC 60 shore $\varnothing 10,80 \text{ mm}$ • HPC502 - Flexible PVC 60 shore $\varnothing 11,20 \text{ mm}$ Complying with CEI 20-35 (IEC 332.1) regulations |
| Colour | Black |
| Electrical resistance | • HPC501 12 Ohm/Km @ 20°C (Power) • HPC502 7,4 Ohm/Km @ 20°C (Power) 54,5 Ohm/Km @ 20°C (Signal) |
| Electrical capacitance | 124 pF/m (Signal) @ 1 KHz |
| Operating temperature | -10°C/+60°C |
| Working tension | 300/500 V (Power) < 50 V AC (Signal) < 75 V DC (Signal) |
| Weight | • HPC501 - 182 Kg/Km • HPC502 - 235 Kg/Km |
| Minimum bending radius | 10 x cable section radius |
| Packaging | 100 m wooden or wood fiber reel |

PROFESSIONAL DMX CABLES

CABLES IN REEL



PROFESSIONAL DMX CABLES O.F.C.

CABLES IN REEL



• I cavi DMX sono specificamente ideati per connettere i mixer luci che utilizzano la trasmissione dati DMX a tutti quei dispositivi (cambiacolori, scanner) che utilizzano questo protocollo. I cavi sono conformi allo standard DMX512 con un'impedenza nominale di 120 Ohm. Grazie al diametro esterno ridotto, è possibile utilizzarli anche con i connettori XLR. Possono essere utilizzati per connessioni audio standard, con ottimi risultati in merito alla trasmissione e purezza del segnale.

• *DMX cables are especially designed to connect lighting mixers using DMX data transmission to any device using this protocol (colour changer, scanner). Cables are made in conformity with the DMX512 standard featuring a 120 Ohm nominal impedance. Thanks to their small overall diameter, it is possible to use these cables also with XLR low profile connectors. They can also be used for standard audio connections with excellent results regarding the transmission and purity of the signal.*

DMXD - DMXDBL

• Cavo professionale DMX ad impedenza costante (120 Ohm) ad una coppia audio bilanciata twistata con guaina esterna a diametro ridotto in PVC flessibile antifiamma. Sezione: 2 x 0.25 mm².
 • *Constant impedance (120 Ohm) - DMX - 1 audio balanced twisted pair (2 x 0,25 mm²) cable with small diameter flexible flame resistant PVC overall Jacket.*

| DMX - DMXDBL | | | |
|---------------------------|---|-------------------------------|---|
| Application fields | <ul style="list-style-type: none"> • Standard DMX connections • Light/colour changer scanner connections • Audio connections | Electrical resistance | 85 Ohm/Km (conductor) @ 20°C 17 Ohm/Km (Shield) @ 20°C |
| Conductors | Bare copper 24 AWG = 14 x 0.15 mm (0.25 mm ²) Complying with IEC 228 Class 5 regulations | Electrical capacitance | 40 pF/m (conductor/conductor) @ 1 KHz 71 pF/m (conductor/Shield) @ 1 KHz |
| Insulation | XLPE Ø 1.80 mm red/natural | Nominal impedance | 120 Ohm |
| Shield | PE filler PES foil 100% Tinned copper braid > 95% | Attenuation | 66 % |
| Jacket | Flame resistant flexible PVC Ø 5.40 mm Complying with IEC 332.1 regulations | Operating temperature | -20°C/+80°C |
| Drain Wire | Tinned copper 24 AWG = 7 x 0.20 mm (0.22 mm ²) | Working tension | < 50 V AC < 75 V DC |
| Colour | Black (DMXD). Blue (DMXDBL) | Weight | 38 Kg/Km |
| | | Minimum bending radius | 25 mm |
| | | Packaging | 100 m carton reel 500 m wooden reel DMXDR500 (only black) |



PROFESSIONAL DMX CABLES O.F.C.

CABLES IN REEL



DMXDD

- Cavo professionale DMX ad impedenza costante a due coppie audio bilanciate twistate con guaina esterna a diametro ridotto in PVC flessibile non propagante l'incendio. Sezione: 2 x 2 x 0.25 mm².
- *Constant impedance DMX 2 audio balanced twisted pairs (2 x 2 x 0,25 mm²) cable with reduced diameter flexible flame retardant PVC overall jacket.*

DMXDD

| | | | |
|---------------------------|--|-------------------------------|---|
| Application fields | <ul style="list-style-type: none"> • Standard DMX connections • Light/colour changer scanner connections • Audio connections | Colour | Black |
| Conductors | Bare copper 24 AWG = 14 x 0.15 mm (0.25 mm ²) Complying with IEC 228 Class 5 regulations | Electrical resistance | 85 Ohm/Km (conductor) @ 20°C 15 Ohm/Km (Shield) @ 20°C |
| Shield | PE filler PES foil 100% Tinned copper braid > 90% | Electrical capacitance | 45 pF/m (conductor/conductor) @ 1 KHz 90 pF/m (conductor/Shield) @ 1 KHz |
| Insulation | XLPE Ø 1.80 mm red/natura | Nominal impedance | 120 Ohm |
| Jacket | Inner pairs: Fire retardant flexible PVC Ø 4.40 mm, complying with IEC 332.1 regulations. Hardness: 67±2 Sh-A Overall: Fire-retardant flexible PVC Ø 12.00 mm, complying with CEI 20-22 standard. Hardness: (67 ± 2) Sh-A | Attenuation | 66 % |
| Drain Wire | Tinned copper 24 AWG = 7 x 0.20 mm (0.22 mm ²) | Operating temperature | -20°C/+80°C |
| | | Working tension | < 50 V AC (Signal) < 75 V DC (Signal) |
| | | Weight | 100 Kg/Km |
| | | Minimum bending radius | 25 mm |
| | | Packaging | 100 m wooden or wood fiber reel (other lengths on request) |



DMXD1

- Cavo professionale DMX ad impedenza costante ad una coppia audio bilanciata twistata e cavo di potenza con guaina esterna a diametro ridotto in PVC flessibile antifiamma. Sezione: Audio 2 x 0.25 mm² - Power 3 x 1.50 mm².
- *Constant impedance DMX 1 audio balanced twisted pair cable (2 x 0,25 mm²) and power cable (3 x 1,5 mm²) with small diameter flexible flame resistant PVC overall Jacket.*

DMXD1

| | | | |
|---------------------------|---|-------------------------------|---|
| Application fields | <ul style="list-style-type: none"> • Standard DMX connections • Light/colour changer scanner connections | Colour | Black |
| Conductors | Bare copper AUDIO: 24 AWG = 14 x 0.15 mm (0.25 mm ²) Complying with IEC 228 Class 5 regulations POWER: 16 AWG = 3 x 1.5 mm (1.55 mm ²) | Electrical resistance | 85 Ohm/Km (conductor) @ 20°C 17 Ohm/Km (Shield) @ 20°C |
| Shield | CONDUCTORS PE filler - Aluminium/Mylard foil 100% - Tinned copper braid 90% CABLE Non wovens | Electrical capacitance | 40 pF/m (conductor/conductor) @ 1 KHz |
| Insulation | AUDIO: PE Ø 1.80 mm red/natural POWER: flame resistant PVC Ø 4.5 mm Complying with IEC 332.1 regulations | Nominal impedance | 120 Ohm |
| Jacket | CONDUCTORS AUDIO: flame resistant flexible PVC Ø 4.50 mm CABLE: flame resistant flexible PVC Ø 9.80 mm Complying with IEC 332.1 regulations | Attenuation | 66 % |
| | | Operating temperature | -20°C/+80°C |
| | | Working tension | 300/500 V (Power) < 50 V AC (Signal) < 75 V DC (Signal) |
| | | Weight | 146 Kg/Km |
| | | Minimum bending radius | 25 mm |
| | | Packaging | 100 m wooden or wood fiber reel |

PROFESSIONAL HYBRID & LAN CABLES

CABLES IN REEL



PROFESSIONAL HYBRID CABLES O.F.C.

CABLES IN REEL



LAN52SPW

• Cavo ibrido professionale, che combina due coppie audio digitali AES/EBU 110 Ohm (compatibili con il segnale analogico) schermate con nastro in alluminio-mylar, un cavo CAT. 5e S-FTP con doppia schermatura realizzata con nastro di alluminio-mylar e treccia in rame stagnato ed un cavo di alimentazione con sezione 3 x 2.5 mm². Tutti i cavi interni sono singolarmente inguainati e la guaina esterna sul totale è realizzata in morbido PVC.

• Professional hybrid cable, combining two aluminum-mylar foil Shielded digital audio AES/EBU 110 Ohm pairs (compatible with the analog signal) and a CAT. 5e S-FTP cable with double Shielding made of aluminum-mylar foil, a tinned copper braid and a 3x2.5 mm² power cable. The four inner cables are individually insulated and the outer sleeve is manufactured from soft PVC.

LAN52SPW

| | | | |
|---------------------------|---|-------------------------------|---|
| Application fields | <ul style="list-style-type: none"> Control DMX Lighting console Self powered loudspeaker Mobile application | Jacket | Soft PVC compound Ø 20,50 mm |
| Conductors | Cat. 5e S-FTP: 24 AWG = 7 x 0.20 mm (0.22 mm ²) Audio pairs: 24 AWG = 28 x 0.10 mm (0.22 mm ²) Bare copper Power: 16 AWG = 50 x 0.254 mm (2,50 mm ²) | Colour | Black |
| Shield | Cat. 5e S-FTP: Alu-mylar foil 100% - Tinned copper braid >80% Audio pair: Al-mylar foil 100% | Electrical resistance | Audio pair: 88 Ohm/Km (conductor) @ 20°C |
| Insulation | Cat. 5e S-FTP: PVC Ø 7 mm Audio pairs: PVC Ø 2.70 mm Power cable: PVC Ø 9.1 mm | Electrical capacitance | Audio pair: 48 pF/mt (cond./cond.) @1 KHz |
| | | Nominal impedance | Audio pair: 110 Ohm |
| | | Operating temperature | -20°C/+70°C |
| | | Working tension | Audio pair: < 50 V AC < 75 V DC Power: 300/500V |
| | | Minimum bending radius | 25 mm |
| | | Packaging | 200 m wooden reel |



LAN61S

• Cavo ibrido professionale, che combina una coppia audio digitale AES/EBU 110 Ohm (compatibile con il segnale analogico) schermata con nastro in alluminio-mylar ed un cavo CAT. 5e S-FTP con doppia schermatura realizzata con nastro di alluminio-mylar e treccia in rame stagnato. I due cavi interni sono singolarmente inguainati e la guaina esterna sul totale è realizzata in morbido PVC.

• Professional hybrid cable, combining an aluminum-mylar foil Shielded digital audio AES/EBU 110 Ohm pair (compatible with the analog signal) and a CAT. 5e S-FTP cable with double Shielding made of aluminum-mylar foil and a tinned copper braid. The two inner cables are individually insulated and the outer sleeve is manufactured from soft PVC.

LAN61S

| | | | |
|--------------------------------|--|-------------------------------|---------------------------------------|
| Application fields | <ul style="list-style-type: none"> Control DMX Lighting console Self powered loudspeaker Mobile application | Jacket | Soft PVC compound Ø 14.00 mm |
| Conductors | Cat. 5e S-FTP: 24 AWG = 7 x 0.20 mm (0.22 mm ²) Audio pair: 24 AWG = 28 x 0.10 mm (0.22 mm ²) Bare copper | Colour | Black |
| Shield | Cat. 5e S-FTP: Al-mylar foil 100% - Tinned copper braid > 80% Audio pair: Al-mylar foil 100% | Electrical resistance | 88 Ohm/Km (conductor) @ 20°C |
| Insulation | Cat. 5e S-FTP: PVC Ø 7 mm Audio pair: PVC Ø 2.70 mm | Electrical capacitance | 48 pF/mt (conductor/conductor) @1 KHz |
| Drain Wire (Audio pair) | 24 AWG = 7 x 0.18 mm (0.22 mm ²) Tinned copper | Nominal impedance | Audio pair: 110 Ohm |
| | | Operating temperature | -20°C/+70°C |
| | | Working tension | Audio pair: < 50 V AC < 75 V DC |
| | | Weight | 260 Kg/Km |
| | | Minimum bending radius | 25 mm |
| | | Packaging | 200 m wooden reel |

• Proel ha progettato la nuova linea di cavi ibridi professionali al fine di offrire, in un solo prodotto, la trasmissione di più tipologie di segnale, quali controllo dati, audio digitale ed alimentazione. Le soluzioni proposte sono molteplici e per diversi utilizzi, garantendo affidabilità ed integrità del segnale anche nelle situazioni più gravose. Le principali applicazioni sono le nuove tecnologie introdotte nei diffusori acustici attivi e fari motorizzati intelligenti altamente professionali, dove si è avuta l'integrazione dei segnali analogico/digitale e dei sistemi di controllo in networking. Oltre a questa nuova serie di prodotti, Proel offre un'evoluzione nel settore dei cavi ethernet (LAN), realizzando due nuovi prodotti per la trasmissione dati ad alta velocità (Class D bit-rates), sia per utilizzo mobile che per installazioni fisse.

PROFESSIONAL HYBRID & LAN CABLES O.F.C.

CABLES IN REEL



• Proel has developed a new range of professional hybrid cables. The principle of this product is to provide, in a single cable, the transmission of multiple signal sources, such as data control, digital audio and power. The proposed solutions are many and for different applications, ensuring reliability and signal integrity even under the most extreme conditions. The main applications are the new technologies introduced in highly professional active speakers and intelligent moving lights. Where there has been integration of an analogue/digital and networking control systems. In addition to this new series of products, Proel provides a development in the field of the Ethernet cables (LAN), creating two new products for transmitting high speed data (Class D bit-rates), both for mobile use and for fixed installations.

LAN62S

• Cavo ibrido professionale, che combina due coppie audio digitali AES/EBU 110 Ohm (compatibili con il segnale analogico) schermate con nastro in alluminio-mylar ed un cavo CAT. 5e S-FTP con doppia schermatura realizzata con nastro di alluminio-mylar e treccia in rame stagnato. I tre cavi interni sono singolarmente inguainati e la guaina esterna sul totale è realizzata in morbido PVC.

• Professional hybrid cable, combining aluminum-mylar foil Shielded two digital audio AES/EBU 110 Ohm pairs (compatible with the analog signal) and a CAT. 5e S-FTP cable with double Shielding made of aluminum-mylar foil and a tinned copper braid. The three inner cables are individually insulated and the outer sleeve is manufactured from soft PVC.

LAN62S

| | | | |
|---------------------------------|--|-------------------------------|--|
| Application fields | <ul style="list-style-type: none"> • Control DMX Lighting console • Self powered loudspeaker • Mobile application | Jacket | Soft PVC compound Ø 14.10 mm |
| Conductors | Cat. 5e S-FTP: 24 AWG = 7 x 0.20 mm (0.22 mm ²) Audio pair: 24 AWG = 28 x 0.10 mm (0.22 mm ²) Bare copper | Colour | Black |
| Shield | Cat. 5e S-FTP: Al-mylar foil 100% - Tinned copper braid > 80% Audio pair: Al-mylar foil 100% | Electrical resistance | 88 Ohm/Km (conductor) @ 20°C |
| Insulation | Cat. 5e S-FTP: PVC Ø 7.00 mm Audio pair: PVC Ø 2.70 mm | Electrical capacitance | 48 pF/mt (conductor/conductor) @ 1 KHz |
| Drain Wire (Audio pairs) | 24 AWG = 7 x 0.18 mm (0.22 mm ²) Tinned copper | Nominal impedance | Audio pair: 120 Ohm |
| | | Operating temperature | -20°C/+70°C |
| | | Working tension | Audio pair: < 50 V AC < 75 V DC |
| | | Weight | 260 Kg/Km |
| | | Minimum bending radius | 25 mm |
| | | Packaging | 200 m wooden reel |



PROFESSIONAL LAN CABLES O.F.C.

CABLES IN REEL



LAN5S

• Cavo professionale per connessioni ethernet CAT. 5e S-FTP, dotato di riempitivo interno unico che garantisce la tenuta delle caratteristiche elettriche nelle applicazioni mobili. Inoltre è provvisto di una doppia schermatura realizzata in nastro di alluminio-mylar e treccia di rame stagnato. Particolarmente indicato per applicazioni in uso mobile. La guaina esterna è realizzata in poliuretano.

• Professional CAT. 5e S-FTP cable for Ethernet connections, featuring unique inner filler to maintain electrical characteristics in portable applications; double Shielding manufactured from aluminum-mylar foil and tinned copper braid. Particularly suitable for mobile applications. The outer sleeve is manufactured from polyurethane compound.

| LAN5S | |
|-------------------------------|---|
| Application fields | • Patch cords and link cables for ethernet connections |
| Conductors | 24 AWG = 7 x 0.20mm (0.14 mm ²) bare copper |
| Insulation | Single conductor: PE Ø 1.05 mm |
| Shield | Aluminium/Mylar foil 100% Tinned copper braid 80% |
| Jacket | Polyurethane compound Ø 7 mm |
| Colour | Black |
| Electrical resistance | 90 Ohm/Km (conductor) @ 20°C |
| Electrical capacitance | 50 pF/mt (cond./cond.) @ 1 KHz |
| Operating temperature | -20°C/+70°C |
| Weight | 55 Kg/Km |
| Minimum bending radius | 15 mm x overall diameter |
| Packaging | 100 m carton reel 500 m wooden reel LAN5SR500 |



LAN6S

• Cavo professionale per connessioni ethernet Cat6 S-UTP 4x2xAWG23/1, costruito con coppie cordate insieme tra loro attorno ad un riempitivo interno unico che garantisce la tenuta delle caratteristiche elettriche nelle applicazioni mobili. E' inoltre provvisto di una doppia schermatura realizzata in nastro di mylar e treccia di rame stagnato. Particolarmente indicato per applicazioni in uso mobile. La guaina esterna è realizzata in poliuretano.

• Professional network cable Cat6 S-UTP 4x2xAWG23/1, built with pairs twisted together around a unique inner filler to maintain electrical characteristics. Featuring double Shielding made of mylar tape and braided tinned copper between two jackets. Particularly indicated for mobile use applications. Outer jacket made by polyurethane.

| LAN6S | |
|-------------------------------|--|
| Application fields | • Patch cords and link cables for ethernet connections |
| Conductors | 23 AWG - Solid bare copper wires - 0.57mm approx |
| Insulation | Single conductor: Polyolefin dielectric - Ø 1,00 mm approx |
| 1 * Shield | Mylar overlapping foil 100% |
| 1 * Jacket | Black PVC compound - Ø 6.2 mm |
| 2nd Shield | Tinned copper braid coverage 80 |
| Jacket | Polyurethane compound Ø 8 mm |
| Colour | Black |
| Electrical resistance | 70 Ohm/Km (conductor) @ 20°C |
| Electrical capacitance | 76 pF/mt (cond./cond.) @ 1 KHz |
| Operating temperature | -40°C/+80°C |
| Weight | 86 Kg/Km |
| Minimum bending radius | 10 mm x overall diameter |
| Packaging | 100 m carton reel 500 m wooden reel LAN6SR500 |

PROFESSIONAL LAN CABLES O.F.C.

CABLES IN REEL



LAN6UTP

• Cavo professionale per connessioni ethernet Cat6 UTP 4x2xAWG23/1, costruito con coppie cordate insieme tra loro attorno ad un riempitivo interno unico che garantisce la tenuta delle caratteristiche elettriche nelle applicazioni mobili. Schermo unico in nastro di mylar. La guaina esterna è realizzata in poliuretano.
 • Professional network cable Cat6 S-UTP 4x2xAWG23/1, built with pairs twisted together around a unique inner filler to maintain electrical characteristics. Featuring mylar overlapping foil Shield. Outer jacket made by polyurethane.

LAN64

| | | | |
|---------------------------|--|-------------------------------|-------------------------------|
| Application fields | • Patch cords and link cables for ethernet connections | Electrical resistance | 70 Ohm/Km (conductor) @ 20°C |
| Conductors | 23 AWG - Solid bare copper wires - 0.57mm approx | Electrical capacitance | 76 pF/mt (cond./cond.) @1 KHz |
| Insulation | Single conductor: Polyolefin dielectric - Ø 1,00 mm approx | Operating temperature | -20°C/+70°C |
| Shield | Mylar overlapping foil 100% | Weight | 46 Kg/Km |
| Jacket | Polyurethane compound Ø 6,2 mm | Minimum bending radius | 15 mm x overall diameter |
| Colour | Black | Packaging | 100 m carton reel |



LAN64

• Cavo professionale per connessioni ethernet multiple, che combina 4 cavi CAT 6, singolarmente inguainati e con schermatura sul totale per mezzo di treccia in rame stagnato. Particolarmente indicato per applicazioni in posa fissa. La guaina esterna è realizzata in PVC resistente alla fiamma.
 • Professional cable for multiple ethernet connections. Combines 4 X CAT 6 cables, individually insulated with overall Shielding by tinned copper braid. Particularly suitable for use in fixed installations. The outer sleeve is manufactured from flame-resistant PVC.

LAN64

| | | | |
|---------------------------|---|-------------------------------|---|
| Application fields | • Digital consoles connections | Electrical resistance | Audio pair: 88 Ohm/Km (conductor) @ 20°C |
| Conductors | Cat 6: 23 AWG = 1 x 0.573 mm (0.26 mm ²) | Electrical capacitance | Audio pair: 53 pF/mt (cond./cond.) @1 KHz |
| Insulation | Single conductor: PE Ø 1.02 mm Single Lan 6: PVC Ø 6.40 mm | Nominal impedance | Audio pair: 100 Ohm |
| Shield | Overall cable: Tinned copper braid 84% | Operating temperature | -20°C/+70°C |
| Jacket | Flame resistant flexible PVC Ø 20,00 mm | Weight | 460 Kg/Km |
| Colour | Black | Minimum bending radius | 15 mm x overall jacket |
| | | Packaging | custom packaging |

PROFESSIONAL LOUDSPEAKER CABLES

CABLES IN REEL



PROFESSIONAL TWISTED FLEXIBLE LOUDSPEAKER CABLES O.F.C. CABLES IN REEL

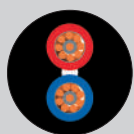

- Linea professionale di cavi flessibili per diffusori acustici, proposta in una vasta gamma di configurazioni per garantire le migliori prestazioni e per adattarsi alle esigenze di ogni connessione con impianti audio dalle applicazioni standard a quelle più critiche. La guaina esterna in PVC e la composizione dei conduttori interni ultra- flessibili, garantiscono sempre un perfetto avvolgimento. Le applicazioni tipiche sono: amplificazione, sistemi di altoparlanti distribuiti e l'installazione in studi di registrazione.

- Professional line of flexible loudspeaker cables, feature a wide range of configurations to guarantee the best achievable performance from standard applications to the most critical ones. Suitable for amplifier to loudspeakers connections. The PVC overall jacket and the composition of the ultra-flexible inner conductors always grant a perfect winding. The typical applications are: sound reinforcement, distributed speaker systems and studio installation.

HPC610BK – HPC620BK – HPC624BK

- Cavo ultra-flessibile a 2 conduttori twistati per diffusori acustici passivi, proposto in diverse configurazioni di sezione.
- Ultra-flexible 2 twisted conductors speaker cable for passive loudspeakers, proposed in different configurations.

HPC610BK - HPC620BK - HPC624BK

| | | | |
|----------------------------------|---|-------------------------------|---|
| Application fields | Passive speaker connections, sound reinforcement, studio installation, live | Minimum bending radius | 10 x overall diameter |
| Conductors | Bare copper – 0,25 mm | Additional notes | Construction & Controls complying with CEI 20-20 regulations |
| Lay up | two conductors twisted in short concentric layers | Packaging | 100 m standard carton / wooden reel 300 m wooden reel HPC610BKR300 HPC620BKR300 (other lengths on request) |
| Jacket | Ultra - Flexible PVC – 60 Shore | | |
| Colour | Black (other colours on request) | | |
| Working Temperature range | -20°C/+70°C | | |

| ORDER CODE | CONDUCTORS | CONDUCTORS INSULATION | JACKET O.D. | ELECTRICAL RESISTANCE @20°C | ELECTRICAL CAPACITANCE @ 1KHz | WEIGHT KG/KM |
|------------|---|-----------------------|-------------|-----------------------------|-----------------------------------|--------------|
| HPC610BK | 16 AWG 30 x 0.25 mm (1.50 mm ²) | Ø 2,70 mm | Ø 7,00 mm | 12 Ohm/Km (conductor) | 115 pF/m (conductor/conductor) | 136 |
| HPC620BK | 13 AWG 48 x 0.25 mm (2.50 mm ²) | Ø 3,20 mm | Ø 8,40 mm | 7,40hm/Km (conductor) | 131 pF/m (conductor/conductor) | 161 |
| HPC624BK | 11 AWG 80 x 0.25 mm (4 mm ²) | Ø 4,00 mm | Ø 11,00 mm | 4,5 Ohm/Km (conductor) | 116 pF/m (conductor/conductor) | 198 |



HPC640BK – HPC644

- Cavo ultra-flessibile a 4 conduttori twistati per diffusori acustici passivi, proposto in diverse configurazioni di sezione.
- Ultra-flexible 4 twisted conductors speaker cable for passive loudspeakers, proposed in different configurations.

HPC640BK - HPC644

| | | | |
|---------------------------|--|----------------------------------|---|
| Application fields | Passive speaker connections, sound reinforcement, live | Working Temperature range | -20°C/+70°C |
| Conductors | Bare copper – 0,25 mm | Minimum bending radius | 10 x overall diameter |
| Lay up | Four conductors twisted in short concentric layers | Additional notes | Construction & Controls complying with CEI 20-20 regulations |
| Jacket | Ultra - Flexible PVC – 60 Shore | Packaging | 100 m wooden or wood fiber reel (other lengths on request) |
| Colour | Black (other colours on request) | | |

| ORDER CODE | CONDUCTORS | CONDUCTORS INSULATION | JACKET O.D. | ELECTRICAL RESISTANCE @20°C | ELECTRICAL CAPACITANCE @ 1KHz | WEIGHT KG/KM |
|------------|---|-----------------------|-------------|-----------------------------|-----------------------------------|--------------|
| HPC640BK | 13 AWG 48 x 0.25 mm (2.50 mm ²) | Ø 3,45 mm | Ø 11,00 mm | 7,4 Ohm/Km (conductor) | 85 pF/m (conductor/conductor) | 204 |
| HPC644 | 11 AWG 53 x 0.25 mm (4.00 mm ²) | Ø 4,20 mm | Ø 13,20 mm | 4,5 Ohm/Km (conductor) | 120 pF/m (conductor/conductor) | 345 |

PROFESSIONAL TWISTED FLEXIBLE LOUDSPEAKER CABLES O.F.C.

CABLES IN REEL



HPC660BK

- Cavo flessibile a 6 conduttori twistati per diffusori acustici passivi.
- Flexible 6 twisted conductors speaker cable for passive loudspeakers.

HPC660BK

| | | | |
|------------------------------|---|-------------------------------|---|
| Application fields | Passive speaker connections, sound reinforcement, live | Electrical capacitance | 100 pF/m (conductor/conductor) @ 1 KHz |
| Conductors | Bare copper 13 AWG = 48 x 0.25 mm (2.5 mm ²) | Operating temperature | -20°C/+70°C |
| Insulation | PVC Ø 3.45 mm | Working tension | 300/500 V |
| Lay up | Six conductors twisted in short concentric layers with a central PVC filler | Weight | 349 Kg/Km |
| Jacket | Flexible PVC 60 shore Ø 12.90 mm | Minimum bending radius | 10 x overall diameter |
| Colour | Black | Additional notes | Construction & Controls: complying with CEI 20-20 regulations |
| Electrical resistance | 7.4 Ohm/Km (conductor) @ 20°C | Packaging | 100 m wooden or wood fiber reel |



HPC685BK

- Cavo flessibile a 8 conduttori twistati per diffusori acustici passivi.
- Flexible 8 twisted conductors speaker cable for passive loudspeakers.

HPC685BK

| | | | |
|------------------------------|---|-------------------------------|---|
| Application fields | Passive speaker connections, sound reinforcement, live | Electrical capacitance | 100 pF/m (conductor/conductor) @ 1 KHz |
| Conductors | Bare copper 13 AWG = 48 x 0.245 mm (2.50 mm ²) | Operating temperature | -20°C/+70°C |
| Insulation | PVC Ø 3.30 mm | Working tension | 300/500 V |
| Lay up | eight conductors twisted in short concentric layers with a central PVC filler | Weight | 365 Kg/Km |
| Jacket | Ultra - Flexible PVC – 60 Shore Ø 13,60 mm | Minimum bending radius | 10 x overall diameter |
| Colour | Black (other colours on request) | Additional notes | Construction & Controls: complying with CEI 20-20 regulations |
| Electrical resistance | 7.4 Ohm/Km (conductor) @ 20°C | Packaging | 100 m wooden or wood fiber reel (other lengths on request) |

PROFESSIONAL TWISTED FLEXIBLE FIRE RESISTANT LOUDSPEAKER CABLES O.F.C. CABLES IN REEL



• Linea professionale di cavi per diffusori acustici passivi particolarmente indicati per installazioni fisse, realizzati con isolamento e guaina esterna in PVC non propagante l'incendio secondo la norma IEC 60332-3. In aggiunta alla versione standard, abbiamo disponibile anche la versione con isolamento e guaina esterna realizzati in materiale termoplastico privo di alogeni (LSZH), quindi utilizzabile in condizioni di installazione con norme più restrittive.

• Professional line of loudspeaker cables for passive speakers, particularly suitable for fixed installations. Insulation and outer jacket made of flame retardant PVC according to IEC 60332-3 regulation. In addition to the standard version, we also have those cables with insulation and outer jacket made of thermoplastic halogen-free (LSZH), therefore suitable for installation with more strictly requirements.

HPC610FT - HPC620FT - HPC624FT

- Cavo a 2 conduttori twistato con guaina esterna in PVC a tubo non propagante la fiamma per diffusori acustici passivi.
- 2 twisted conductors loudspeaker cable with flame retardant tube style PVC overall jacket.

| HPC610FT - HPC620FT - HPC624FT | | | |
|--------------------------------|---|----------------------------------|---|
| Application fields | Passive speaker for fixed installation | Colour | Black |
| Conductors | 0,25 mm Class 5 electrolytic bare copper flexible conductor in compliance with IEC 60228 standard | Working Temperature range | -20°C/+70°C at fixed laying |
| Lay up | two conductors twisted in short concentric layers | Minimum bending radius | 10 x overall diameter |
| Insulation | Red and Blue Rz type PVC complying with EN 50363-0. Hardness (90 ± 2) Shore-A | Notes | Construction & Controls complying with IEC 60332-3 standard |
| Jacket | Tube extruded outer sheath with Rz type PVC complying with EN 50363-0 standard. Hardness : (90 ± 2) Shore-A | Packaging | 100 m carton/wooden reel (other lengths on request) |

| ORDER CODE | CONDUCTORS | CONDUCTORS INSULATION | JACKET O.D. | ELECTRICAL RESISTANCE @20°C | WEIGHT KG/KM |
|------------|---|-----------------------|-------------|-----------------------------|--------------|
| HPC610FT | 16 AWG 28 x 0.25 mm (1.50 mm ²) | Ø 2,50 mm | Ø 6,80 mm | 13,3 Ohm/Km (conductor) | 83,60 |
| HPC620FT | 13 AWG 48 x 0.25 mm (2.50 mm ²) | Ø 2,90 mm | Ø 7,60 mm | 7,98 Ohm/Km (conductor) | 122,40 |
| HPC624FT | 11 AWG 52 x 0.30 mm (4.00 mm ²) | Ø 3,80 mm | Ø 9,20 mm | 4,95 Ohm/Km (conductor) | 83,60 |



HPC610HF - HPC620HF - HPC624HF

- Cavo flessibile a 2 conduttori twistato con guaina esterna in PVC zero alogeni (LSZH) a tubo non propagante la fiamma per diffusori acustici passivi.
- Flexible 2 twisted conductors loudspeaker cable with halogen-free (LSZH) flame retardant PVC overall jacket.

| ORDER CODE | CONDUCTORS | CONDUCTORS INSULATION | JACKET O.D. | ELECTRICAL RESISTANCE @20°C | WEIGHT KG/KM |
|------------|---|-----------------------|-------------|-----------------------------|--------------|
| HPC610HF | 16 AWG 28 x 0.25 mm (1.50 mm ²) | Ø 2,50 mm | Ø 6,80 mm | 13,3 Ohm/Km (conductor) | 83,60 |
| HPC620HF | 13 AWG 48 x 0.25 mm (2.50 mm ²) | Ø 2,90 mm | Ø 7,60 mm | 7,98 Ohm/Km (conductor) | 122,40 |
| HPC624HF | 11 AWG 52 x 0.30 mm (4.00 mm ²) | Ø 3,80 mm | Ø 9,20 mm | 4,95 Ohm/Km (conductor) | 83,60 |

| HPC610HF - HPC620HF - HPC624HF | | | |
|--------------------------------|--|----------------------------------|---|
| Application fields | Passive speaker for fixed installation | Colour | Blue (RAL5010) |
| Conductors | 0,25 mm Class 5 electrolytic bare copper flexible conductor in compliance with IEC 60228 standard | Working Temperature range | -20°C/+70°C at fixed laying |
| Lay up | two conductors twisted in short concentric layers | Minimum bending radius | 10 x overall diameter |
| Insulation | Red and Blue thermoplastic halogen-free material. Hardness (50 ± 2) Shore-A | Notes | Construction & Controls complying with IEC 60332-3 standard |
| Jacket | Tube extruded outer sheath with M1 type halogen-free thermoplastic material. Hardness : (45 ± 2) Shore-A | Packaging | 100 m carton/wooden reel (other lengths on request) |

PROFESSIONAL FLAT SPEAKER & HOME HI-FI CABLES

CABLES IN REEL



HPC700 - HPC710

• Cavo professionale piatto a 2 conduttori con guaina esterna in PVC flessibile trasparente per diffusori acustici passivi. Conduttori in rame stagnato e rame rosso per una facile riconoscibilità della polarizzazione.
 • Professional 2- conductors flat cable with flexible PVC overall jacket in transparent colour for passive speakers. Tinned copper and red copper conductors strength for an easy polarization recognition.

| HPC700 - HPC710 | |
|----------------------------------|--|
| Application fields | • Speaker connections • Home HI-FI connections |
| Working Temperature range | -30°C/+70°C |
| Conductors | Extra fine bare copper and tinned copper = 0.15 mm |
| Minimum bending radius | 10 x overall diameter |
| Jacket | Flexible PVC 64 shore |
| Packaging | 100 m carton reel |
| Colour | Translucent red |

| ORDER CODE | CONDUCTORS | CONDUCTORS INSULATION | JACKET O.D. | ELECTRICAL RESISTANCE @20°C | ELECTRICAL CAPACITANCE @ 1KHz | WEIGHT KG/KM |
|------------|---|-----------------------|-------------|-----------------------------|-------------------------------|--------------|
| HPC700 | 16 AWG 3x28x0,15 mm (1.50 mm ²) | Ø 3,50 mm | 2*Ø 3,50 mm | 8,70 Ohm/Km (conductor) | 80 pF/m (conductor/conductor) | 83,60 |
| HPC710 | 12 AWG 3x56x0,15 mm (3.00 mm ²) | Ø 4,60 mm | 2*Ø 4,60 mm | 3,75 Ohm/Km (conductor) | 80 pF/m (conductor/conductor) | 138,00 |



HPC752RN- HPC754RN - HPC756RN

• Cavo professionale piatto a 2 conduttori in rame rosso con guaina esterna in PVC flessibile.
 • Professional bare copper 2-conductors flat cable with flexible PVC overall jacket.

| HPC752RN - HPC745RN - HPC756RN | |
|----------------------------------|---|
| Application fields | • Speaker connections • Home HI-FI connections |
| Working tension | 300/300 V |
| Conductors | Extra fine bare copper = 0.20 mm |
| Minimum bending radius | 4 x overall diameter |
| Jacket | Flexible flame resistant PVC 60 shore |
| Packaging | 200 m carton reel |
| Colour | Black/Red |
| Working Temperature range | -10°C/+70°C |

| ORDER CODE | CONDUCTORS | CONDUCTORS INSULATION | JACKET O.D. | ELECTRICAL RESISTANCE @20°C | ELECTRICAL CAPACITANCE @ 1KHz | WEIGHT KG/KM |
|------------|---|-----------------------|-------------|-----------------------------|-----------------------------------|--------------|
| HPC752RN | 18 AWG 24x0.20 mm (0.75 mm ²) | Ø 2,35 mm | 2*Ø 2,35 mm | 26,00 Ohm/Km (conductor) | 100 pF/m (conductor/conductor) | 23,30 |
| HPC754RN | 17 AWG 32x0.20 mm (1.00 mm ²) | Ø 2,80 mm | 2*Ø 2,80 mm | 19,50 Ohm/Km (conductor) | 114 pF/m (conductor/conductor) | 32,40 |
| HPC756RN | 16 AWG 28x0.25 mm (1.50 mm ²) | Ø 3,20 mm | 2*Ø 3,20 mm | 13,30 Ohm/Km (conductor) | 115 pF/m (conductor/conductor) | 44,90 |

PROFESSIONAL MULTICORE POWER CABLES

CABLES IN REEL



PROFESSIONAL MULTICORE POWER CABLES O.F.C.

CABLES IN REEL

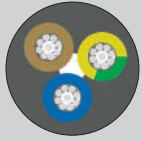

HPC3015FG - HPC3025FG

- Cavo multipolare professionale di potenza a 3 conduttori con guaina esterna in PVC/NBR flessibile, antiabrasione, non propagante la fiamma e a bassa emissione di gas corrosivi. Sezione: HPC3015FG - 3 x 1.50 mm² / HPC3025FG - 3 x 2.50 mm².
- Professional 3-conductor multicore power cable (HPC3015FG - 3 x 1,5 mm² / HPC3025FG - 3 x 2,5 mm²) with flame retardant, flexible, antiabrasive and low corrosive gas emission PVC/NBR overall jacket.



HPC1925FGN

• I cavi multipolari serie FIREGUARD rispondono alla norma CEI 20-22 e CEI 20-37, sono dotati di guaina in polivinilcloruro non propagante l'incendio, a ridotta emissione di gas corrosivi, di conduttori in rame stagnato a corda flessibile isolati in polivinilcloruro e caratterizzati da alta resistenza all'abrasione. Con questa serie di cavi la divisione "Professional Cable" di PROEL risponde alla richiesta crescente di cavi non propaganti la fiamma, dotati anche di spiccate caratteristiche di flessibilità. Questo risultato è stato raggiunto grazie allo studio di una nuova miscela capace di coniugare due aspetti fondamentali per l'installazione professionale: sicurezza e maneggevolezza.

• PROEL multicore power cables are fully protected by a fire retardant, anti fumes release PVC flexible and resistant jacket, in conformity with the CEI 20-22/II CEI 20-37 standards. These cables are recommended for very high current carrying capacity (450-750 volts). Moreover, featuring ease of handling and winding, even in extreme conditions, they are especially recommended for both indoor applications (discos, indoor sports arenas, theatres, etc.) and big outdoor installations (live concerts and shows, etc.).

- Cavi multipolari professionali di potenza con guaina esterna in PVC/NBR flessibile, antiabrasione, non propagante la fiamma ed a bassa emissione di fumi e gas corrosivi. Particolarmente adatti per prolunghe da utilizzare con sistemi lighting e sistemi di alimentazione. Sezione: HPC1925FGN - 19 x 2.50 mm².
- Professional multicore power cables with flame retardant, flexible, antiabrasive and low corrosive gas emission PVC/NBR overall jacket. Particularly suitable for both lighting systems and power systems extension. Section: HPC1925FGN - 19 x 2.50 mm².

HPC3015FG - HPC3025FG - HPC1925FGN

| | | | |
|---------------------------|---|-------------------------------|---|
| Application fields | <ul style="list-style-type: none"> • Disco/theatre/stadium cabling • Outdoor installations | Colour | Black |
| Conductors | Tinned copper <ul style="list-style-type: none"> • HPC3015FG: 16 AWG = (3 conductors x 1.50 mm²) • HPC3025FG: 13 AWG = 48 x 0.25 mm (3 conductors x 2.50 mm²) • HPC1925FGN: 14 AWG = 48 x 0.25 mm (19 conductors x 2.50 mm²) | Electrical resistance | According with IEC 228/HD 383 S2 (CEI 20-29) |
| Insulation | PVC T12 NPI type Black-Yellow/Green | Operating temperature | -20°C/+70°C |
| Jacket | Special PVC / NBR <ul style="list-style-type: none"> • HPC3015FG: Ø 8.50 ± 0.2 mm • HPC3025FG: Ø 10.20 ± 0.2 mm • HPC1925FGN: Ø 19.80 mm Complying with CEI 20-22 II regulations | Working tension | 300/500 V |
| | | Weight | <ul style="list-style-type: none"> • HPC3015FG: 113 Kg/Km • HPC3025FG: 160 Kg/Km • HPC1925FGN: 841 Kg/Km |
| | | Minimum bending radius | 6 x overall diameter |
| | | Packaging | HPC3015FG - HPC3025FG - HPC1925FGN custom packaging |

EMPTY CABLE DRUMS "AV" SERIES

CABLES IN REEL

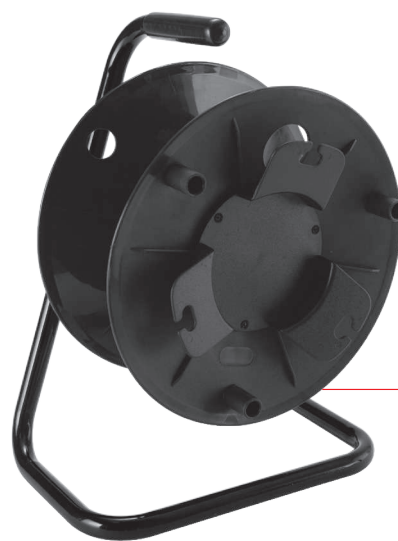

AV090

AV090

- Avvolgicavo cieco in Nylon con struttura in metallo, freno e manovella per avvolgimento. Dotato di pratica flangia frontale per la raccolta del cavo. Diametro esterno: Ø 275 mm. Colore: Nero.
- Blind Nylon empty cable reel with metal frame, brake and crank for winding. Equipped with a practical cable holder front flange. Outer Diameter: 275 mm. Colour: Black.



AV185



AV185

- Avvolgicavo professionale infrangibile vuoto di piccole dimensioni, particolarmente adatto per prolunghie di cavi microfonici/DMX fino a 50 metri. Combina la struttura ad alta resistenza realizzata in Policarbonato (PC) con il tamburo in Polietilene (PE). Fornito di serie con una pratica flangia anteriore per la raccolta dei cavi. E' inoltre provvisto di manopola per l'avvolgimento e di un freno regolabile nella parte posteriore. Diametro esterno: Ø 235 mm. Capacità indicativa cavo: Ø 3 mm - 315 m; Ø 7 mm - 57 m. Colore: Nero.
- Professional unbreakable small empty cable drum, particularly suitable for extensions of mic / DMX cables up to 50 meters. Combines high tensile structure made of Polycarbonate (PC) with the drum made of Polyethylene (PE); it comes with a handy knob for winding and adjustable brake at the rear. Overall diameter: Ø 235 mm. Approx. cable capacity: Ø 3 mm - 315 m; Ø 7 mm - 57 m. Colour: Black.

EMPTY CABLE DRUMS "AV" SERIES

CABLES IN REEL



AV190

AV190

- Avvolgicavo professionale infrangibile vuoto di medie dimensioni. Combina la struttura ad alta resistenza realizzata in Policarbonato (PC) con il tamburo in Polietilene (PE). Fornito di serie con una pratica flangia anteriore per la raccolta dei cavi. E' inoltre provvisto di manopola per l'avvolgimento e di un freno regolabile nella parte posteriore. Diametro esterno: Ø 310 mm. Capacità indicativa cavo: Ø 6 mm - 168 m; Ø 6,5 mm - 138 m; Ø 8 mm - 90 m; Ø 10 mm - 63 m; Ø 12 mm - 38 m. Colore: Nero.

- Professional unbreakable medium empty cable drum. Combines high tensile structure made of Polycarbonate (PC) with the drum made of Polyethylene (PE); it comes with a handy front flange for cable harvesting. It also has a handy knob for winding and adjustable brake at the rear. Overall diameter: Ø 310 mm. Approx. cable capacity: Ø 6 mm - 168 m; Ø 6,5 mm - 138 m; Ø 8 mm - 90 m; Ø 10 mm - 63 m; Ø 12 mm - 38 m. Colour: Black.



AV195

- Avvolgicavo professionale infrangibile vuoto di grandi dimensioni, da poter utilizzare anche per piccoli sistemi Audio fino a 20 canali / 50 metri di lunghezza. Combina la struttura ad alta resistenza realizzata in Policarbonato (PC) con il tamburo in Polietilene (PE). Fornito di serie con una pratica flangia anteriore per la raccolta dei cavi. E' inoltre provvisto di manopola per l'avvolgimento e di un freno regolabile nella parte posteriore. Il tamburo ha un diametro esterno di Ø 380 mm ed è dotato di una flangia/adattatore, per il montaggio dei dischi forati del modello AV190. Capacità indicativa cavo: Ø 3 mm - 1300 m; Ø 7 mm - 230 m; Ø 15 mm - 40 m. Colore: Nero.

- Professional unbreakable large empty cable drum. It can be used for small Audio Systems up to 20 channels / 50 mt. length. Combines high tensile structure made of Polycarbonate (PC) with the drum made of Polyethylene (PE); it comes with a handy front flange for cable harvesting. It also has a handy knob for winding and adjustable brake at the rear. The drum has an outer diameter of Ø 380 mm and is equipped with a flange / adapter, for the assembly of the perforated discs of the AV190 model. Approx. cable capacity: Ø 3 mm - 1300 m; Ø 7 mm - 230 m; Ø 15 mm - 40 m. Colour: Black.



AV195

EMPTY CABLE DRUMS "AV" SERIES ACCESSORIES

CABLES IN REEL

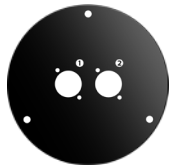
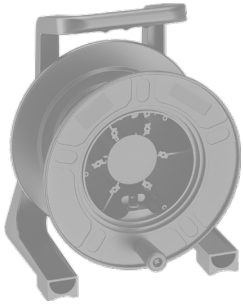

AV185D02

- Disco frontale in acciaio verniciato nero per AV185, dotato di 2 fori per connettori di tipo "D"
- *Front disc made of black painted steel for AV185. Featuring 2 x "D-type" connector hole.*

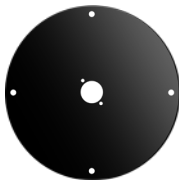
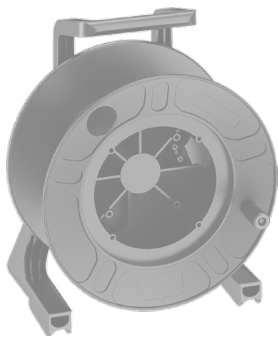

AV190D01

- Disco frontale in acciaio verniciato nero per AV190/AV195, dotato di 1 foro per connettori di tipo "D"
- *Front disc made of black painted steel for AV190/AV195. Featuring 1 x "D-type" connector hole.*

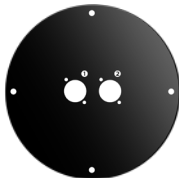

AV190D02

- Disco frontale in acciaio verniciato nero per AV190/AV195, dotato di 2 fori per connettori di tipo "D"
- *Front disc made of black painted steel for AV190/AV195. Featuring 2 x "D-type" connector hole.*

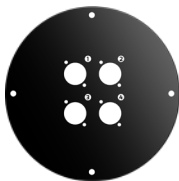

AV190D04

- Disco frontale in acciaio verniciato nero per AV190/AV195, dotato di 4 fori per connettori di tipo "D"
- *Front disc made of black painted steel for AV190/AV195. Featuring 4 x "D-type" connector hole.*

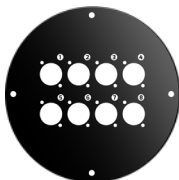

AV190D08

- Disco frontale in acciaio verniciato nero per AV190/AV195, dotato di 8 fori per connettori di tipo "D"
- *Front disc made of black painted steel for AV190/AV195. Featuring 8 x "D-type" connector hole.*

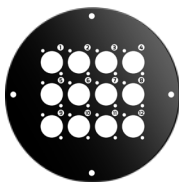

AV190D12

- Disco frontale in acciaio verniciato nero per AV190/AV195, dotato di 12 fori per connettori di tipo "D"
- *Front disc made of black painted steel for AV190/AV195. Featuring 12 x "D-type" connector hole.*

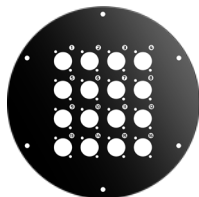

AV195D16

- Disco frontale in acciaio verniciato nero per AV195, dotato di 16 fori per connettori di tipo "D"
- *Front disc made of black painted steel for AV195. Featuring 16 x "D-type" connector hole.*

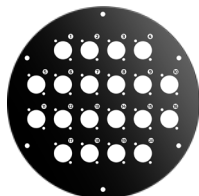

AV195D20

- Disco frontale in acciaio verniciato nero per AV195, dotato di 20 fori per connettori di tipo "D"
- *Front disc made of black painted steel for AV195. Featuring 20 x "D-type" connector hole.*

EMPTY CABLE DRUMS "AV" PROFESSIONAL SERIES

CABLES IN REEL



AV310N



AV310N

- Avvolgicavo professionale con struttura in metallo verniciata ad alta resistenza, il PROEL AV310N è un rullo di grande capacità, dotato di freno regolabile, sistema di riavvolgimento, manovella e quattro ruote \varnothing 60 mm. Fornito con disco cieco e disco a 32 fori. Adattabile a sistemi audio "Stage Box" applicando i connettori sulla flangia esterna.
- Professional cable winder with sturdy paint finish metal, PROEL AV310N is a high capacity drum, equipped with an adjustable brake, rewind system, crank handle and four \varnothing 60 mm wheels. Supplied with blank disc and 32 holes disc. Easily adaptable to "Stage Box" audio systems by using connectors on the external flange.

AV405N

- Avvolgicavo in metallo verniciato ad alta resistenza, manovella rimovibile, freno a frizione regolabile, flangia separatrice per alloggiare il terminale del cavo e i connettori in compartimenti separati.
- Sturdy paint finish metal cable winder, removable crank handle, adjustable friction brake, separating flange to secure bulky cable end connectors in separate compartments.

AV415N

- Avvolgicavo in metallo verniciato ad alta resistenza, ruote per un facile trasporto, manovella rimovibile, freno a frizione regolabile, flangia separatrice per alloggiare i connettori terminali del cavo in compartimenti separati.
- Sturdy paint finish metal cable winder, wheels for easy transport, removable crank handle, adjustable friction brake, separating flange to secure bulky cable end connectors in separate compartments.

AV425N

- Avvolgicavo di grande capacità in metallo verniciato ad alta resistenza, manovella rimovibile, freno a frizione regolabile, flangia separatrice per alloggiare i connettori terminali del cavo in compartimenti separati.
- Sturdy paint finish metal cable winder, wheels for easy transport, removable crank handle, adjustable friction brake, separating flange to secure bulky cable end connectors in separate compartments.

FRAME DIMENSION (mm)

| CODE | Width | Height | Depth |
|--------|----------------------------|-----------------|-----------------|
| AV310N | 490/620 mm (19.29"/24.40") | 640 mm (25.19") | 390 mm (15.35") |
| AV405N | 440 mm (17.32") | 465 mm (18.30") | 465 mm (18.30") |
| AV415N | 530 mm (20.86") | 465 mm (18.30") | 465 mm (18.30") |
| AV425N | 680 mm (26.77") | 465 mm (18.30") | 465 mm (18.30") |

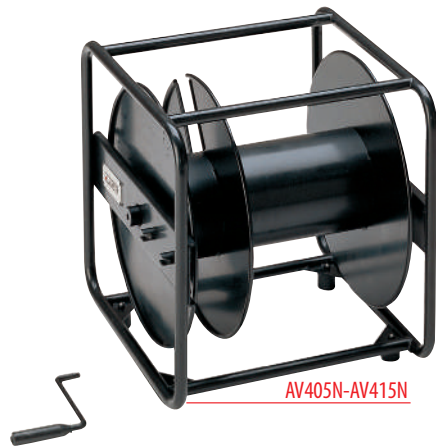

AV405N-AV415N



AV425N

| MODEL | CABLE DIAMETER / METERS | | | | | | | | | | | |
|--------|-------------------------|---------|---------|---------|---------|---------|---------|---------|---------|---------|---------|---------|
| | 0 8 mm | 0 10 mm | 0 12 mm | 0 15 mm | 0 18 mm | 0 20 mm | 0 22 mm | 0 24 mm | 0 26 mm | 0 28 mm | 0 30 mm | 0 32 mm |
| AV310N | 227 m | 145 m | 101 m | 64 m | 45 m | 36 m | 30 m | 25 m | / | / | / | / |
| AV405N | / | 240 m | 170 m | 110 m | 75 m | 60 m | 50 m | 45 m | 35 m | 30 m | 28 m | 24 m |
| AV415N | / | / | 230 m | 150 m | 100 m | 80 m | 70 m | 60 m | 50 m | 40 m | 36 m | 32 m |
| AV425N | / | / | / | 210 m | 150 m | 120 m | 100 m | 80 m | 70 m | 60 m | 52 m | 45 m |

CONNECTORS

• PROEL produce connettori sin dalla sua nascita, e da allora ha sviluppato una profonda conoscenza dei requisiti dei connettori professionali audio/video, in quanto essi sono uno degli elementi più importanti per tutti i tipi di collegamenti. In questi anni, varie ricerche di mercato hanno dimostrato che la nostra gamma di connettori professionali è in grado di soddisfare le più diverse esigenze di interconnessione professionale, e naturalmente poniamo attenzione a proporre prezzi competitivi senza penalizzare in alcun modo l'alta qualità dei connettori. Nelle pagine successive, insieme alla nostra serie completa di connettori professionali per applicazioni Audio/Video/Potenza e ad una serie completamente nuova di adattatori, troverete una selezione dei connettori delle marche più conosciute che abbiamo scelto di distribuire, per fornire un catalogo veramente completo di prodotti in grado di soddisfare adeguatamente ogni esigenza.

• PROEL has been producing connectors since its beginnings, and since then, we have developed a deep knowledge of the professional audio/video connectors requirements, as they are one of the most important elements in any kind of connection. In recent years, several market researches have shown that our range of connectors is able to satisfy the most various professional interconnection requirements. Obviously, our experience has always allowed us to offer competitive prices without penalizing in any way the high quality of connectors. In the following pages, you will find our complete range of professional connectors for Audio/Video/Power applications and a completely new line of adapters. As well, you will find a selection of connectors of the most famous brands we have chosen to distribute in order to supply a really complete catalogue of products able to satisfy any requirement properly.



MAIN TYPES OF CONNECTORS

CONNECTORS

- **JACK Ø 6.3 mm. -1/4" (Mono/Stereo - Spina/Presa - Volante/da Pannello)**
Si tratta di connettori coassiali con innesto a baionetta. Esistono nelle versioni a 2 contatti (Mono, indicato anche come TR [Tip, Ring] - Punta, Anello) e a 3 contatti (Stereo, indicato anche come TRS [Tip, Ring, Slave] - Punta, Anello, Massa). La versione a 2 contatti è universalmente impiegato per la connessione degli strumenti musicali, dei processori d'effetto, dei mixer (linea sbilanciata). La versione a 3 contatti è usata per le cuffie Stereo, per le prese combinate di insert, per talune linee bilanciate.
- **JACK Ø 3.5 mm. (Mono/Stereo - Spina/Presa - Volante/da Pannello)**
Indicato anche come Minijack, questo connettore a baionetta trova il suo principale utilizzo negli strumenti audio di ridotte dimensioni come lettori CD portatili, Walkman, Minidisk, Lettori MP3.
- **XLR (3-4-5-7 poli - Spina/Presa - Volante/da Pannello)**
Sono anche detti "Cannon" dal nome della ditta che per primi li ha commercializzati. Si tratta di connettori metallici o in plastica dotati da 3 a 7 contatti con innesto a scatto e pulsante di sicurezza anti-sgancio. Il tipo a 3 contatti è probabilmente il connettore più impiegato nell'audio professionale: rappresenta lo standard per la trasmissione del segnale dai microfoni ed in generale ovunque necessiti un collegamento audio bilanciato (la connessione bilanciata permette di utilizzare cavi di connessione molto lunghi senza che si abbia perdita di segnale ed è esente da disturbi in radiofrequenza data l'elevata schermatura possibile grazie alle tre polarità (due per il segnale e una di schermatura). Il pin 1 corrisponde sempre allo schermo. Esistono invece due standard per l'attribuzione degli altri due pin: alcune apparecchiature più vecchie utilizzano il 3 per il caldo e il 2 per il ritorno. Componenti più recenti invece utilizzano il 2 per il caldo ed il 3 per il ritorno. Se si collega un connettore XLR con uno standard ad un ingresso/uscita avente l'altro standard si ottiene un segnale invertito in fase, nel caso di linea bilanciata, nel caso invece di linee sbilanciate otterremo un corto circuito. I connettori XLR sono usati anche per linee ad alto livello come quelle dai finali agli altoparlanti, per loro è infatti indicata una portata massima di corrente di 15 A. Lo standard per i collegamenti ad alto livello prevede il negativo sul pin 1 ed il positivo sui pin 2 e 3 insieme.
- **SPEAKON (2-4-8 poli - Spina/Presa - Volante/da Pannello)**
Sono connettori in plastica specificatamente concepiti per segnali ad alto livello, in particolare per i cavi che vanno ai diffusori. Esistono in tre versioni: a 2 contatti (per amplificazione), a 4 contatti (per bi-amplificazione) ed a 8 contatti (per quadriamplificazione). Il loro innesto a baionetta è protetto da un fermo metallico che non ne consente la disconnessione accidentale.
- **RCA**
Sono piccoli connettori coassiali in metallo o plastica colorata a 2 contatti. Sono usati nell'alta fedeltà per collegamenti di segnale a basso livello. Inoltre gli RCA (chiamati anche pin jack o "Cinch") possono essere impiegati per connessioni digitali semiprofessionali (standard SPDIF), in questo caso occorre però impiegare connettori di ottima qualità, possibilmente con contatti placcati in oro.
- **BNC (Spina/Presa - Volante/da Pannello)**
Connettore terminale per cavi di segnale di tipo coassiale utilizzato soprattutto in ambito video/audio. Permette un buon contatto e possiede una buona resistenza meccanica. Benché sia stato realizzato per terminare i cavi di tipo coassiale nell'ambito del video professionale, tale standard - visto l'uso sempre più frequente di cavi coassiali come cavi di trasmissione di segnali audio - si esteso anche in ambito audio a livello professionale.
- **DIN (3-5 poli - Spina/Presa - Volante/da Pannello)**
Un tempo venivano usati universalmente nell'alta fedeltà, prima di venire definitivamente soppiantati dagli RCA. Attualmente il loro uso è limitato ai cavi M.I.D.I. per la trasmissione del protocollo digitale degli strumenti musicali, e a taluni cavi di controllo per dimmer analogici (Strand Lighting) o per la trasmissione dei segnali DMX.
- **CONNETTORI DIGITALI AES/EBU (Spina/Presa - Volante/da Pannello)**
Connettori XLR a tre contatti utilizzati per la connessione standard dei segnali audio digitali bilanciati per consentire la comunicazione tra dispositivi digitali.
- **CONNETTORI TRASMISSIONE DATI (Spina/Presa - Volante/da Pannello)**
Nuova tipologia di connettori RJ45 per la trasmissione dati (sia 10Base-T sia 100Base-T) in ambienti estremi. Utilizzato per tutti i cavi CAT 5, questo connettore viene utilizzato anche per il protocollo luci DMX.
- **JACK Ø 6.3 mm -1/4" (Mono/Stereo - Plug/Socket - Cable Mount/Panel Mount) Bayonet locking coaxial connectors.** They can be found in the 2-contact version (mono, also indicated as TR [Tip, Ring]) and in the 3-contact version (stereo, also indicated as TRS [Tip, Ring, Slave]). The 2-contact version is universally employed for the connection of musical instruments, of effect processors and of mixers (unbalanced line). The 3-contact version is used for stereo.
- **JACK Ø 3.5 mm (Mono/Stereo - Plug/Socket - Cable Mount/Panel Mount) Iso** indicated as Minijack, this bayonet mount connector finds its main usage in small size audio equipments such as Portable CD Players, Walkman, Minidisk Players, MP3 Players.
- **XLR (3-4-5-7 pole - Plug/Socket - Cable Mount/Panel Mount)**
Also called "Cannon" from the name of the company which commercialized them first. They are 3 to 7-pole latch lock metal or plastic connectors with security anti-release switch. The 3-contact type is probably the most employed connector in the professional audio: it represents the standard in the transmission of the signal from microphones and in general wherever a balanced audio connection is required (the balanced connection allows the use of very long connection cables without having any signal loss. It is also free from radio frequency interferences because of the high shielding possible thanks to the three polarities (two for the signal and one as shield). Pin 1 always corresponds to shield. There are two standards for the attribution of the other two pins instead: some older equipments use 3 for positive and 2 for negative. More recent components use 2 for positive and 3 for negative instead. If you connect a XLR connector with a standard to an input/output port having the other standard, you will get an inverted signal in-phase in case of balanced line, a short circuit in case of unbalanced lines instead. The XLR connectors are also used for high level lines like the ones going from amplifiers to loudspeakers. In fact, for them it is recommended a 15 A maximum current capacity. The standard for high level connections is designed to have negative on pin 1 and positive on pins 2 and 3 together.
- **SPEAKON (2-4-8 pole - Plug/Socket - Cable Mount/Panel Mount)** They are plastic connectors specifically designed for high level signals, especially for speaker cables. There are three versions: 2-contact (for amplification), 4-contact (for bi-amplification) and 8-contact (for quad amplification) versions. Their bayonet locking system is protected by a metal retainer preventing its accidental disconnection.
- **RCA**
They are small 2-contact coaxial metal or colour plastic connectors. They are used in hi-fi for low level signal connections. Moreover, RCA connectors (also called pin jack or "Cinch") can be employed in semiprofessional digital connections (standard SPDIF). Anyway in this case it is necessary to use best quality, possibly gold plated contact connectors.
- **BNC (Plug/Socket - Cable Mount/Panel Mount)**
Terminal connector for coaxial signal cables used especially in the video/audio application range. It allows a good contact and has a good mechanical resistance. Although designed for coaxial cables in the professional video application range, this standard - as coaxial cables are more and more frequently used as audio signal transmission cables - has also been extended to the professional audio field.
- **DIN (3-5 pole - Plug/Socket - Cable Mount/Panel Mount)**
Once they were universally used in hi-fi, before being permanently replaced by RCA connectors. At the moment their usage is limited to M.I.D.I. cables for the transmission of musical instruments digital protocol and to some control cables for analogic dimmers (Strand Lighting) or for DMX signals transmission.
- **CAES/EBU DIGITAL CONNECTORS (Plug/Socket - Cable Mount/Panel Mount)**
XLR three-contact connectors used for standard connection of balanced digital audio signals in order to allow the communication among digital devices.
- **DATA TRANSMISSION CONNECTORS (Plug/Socket - Cable Mount/Panel Mount)**
New type of RJ45 connectors for data transmission (both 10Base-T and 100Base-T systems) in harsh environments. Used for all CAT 5 cables, this connector is also used for DMX light protocol.

MAIN ASSEMBLING INSTRUCTIONS

CONNECTORS

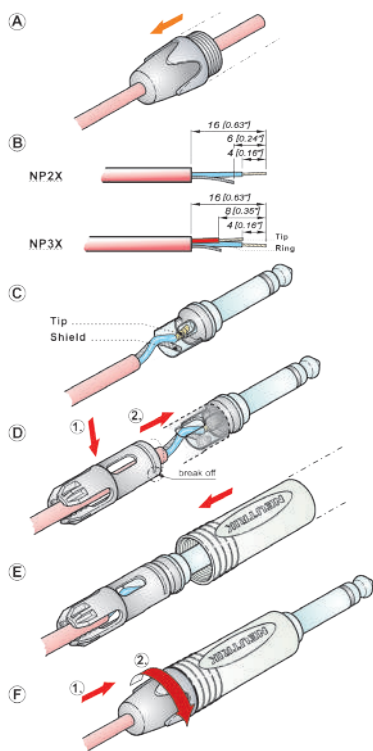

JACK

- A) Inserire il passacavo sul cavo.
- B) Preparare il cavo come indicato.
- C) Saldare le estremità del cavo.
- D) Inserire la pinza del connettore ed allinearla alla spina.

Attenzione:

Se si ura un cavo con Ø esterno 5.50 mm [0.216"] togliere questa parte della pinza.

- E) Inserire il corpo del connettore sulla spina.
- F) Terminare l'installazione serrando il connettore con il passacavo.

JACK

- A) Slide the boot onto the cable.
- B) Prepare cable as shown.
- C) Solder the wire ends.
- D) Position the chuck onto the cable and align chuck with plugfinger.

Attention:

If using a cable with O.D. > 5.50 mm [0.216"] break away this part of the chuck.

- E) Slide the housing onto the plugfinger with the chuck.
- F) Finish the installation by tighten the bushing onto the connector.

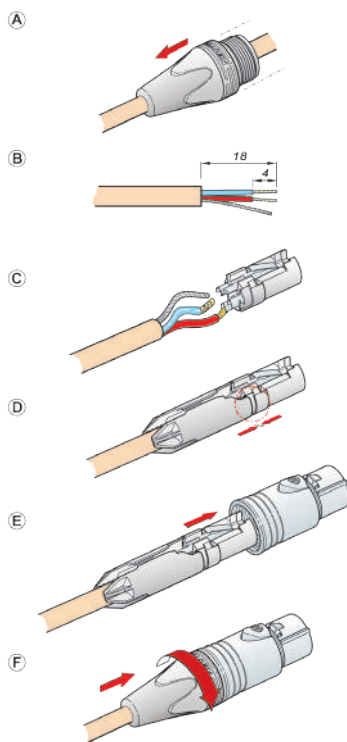

XLR

- A) Inserire il passacavo sul cavo.
- B) Preparare il cavo come indicato.
- C) Inserire i conduttori all'interno dei terminali e procedere alla saldatura.
- D) Inserire la pinza sul cavo.

Attenzione: Allineare la pinza al connettore come indicato.

- E) Inserire l'inserto e la pinza all'interno del corpo connettore.
- F) Terminare l'installazione serrando il corpo connettore con il passacavo.

XLR

- A) Slide the boot onto the cable.
- B) Prepare cable as shown.
- C) Insert wires into the terminals and solder them.
- D) Put chuck onto the cable.

Attention: Pay attention to the guiding key.

- E) Slide insert and chuck together into the housing.
- F) Finish the installation by turning the bushing onto the connector.

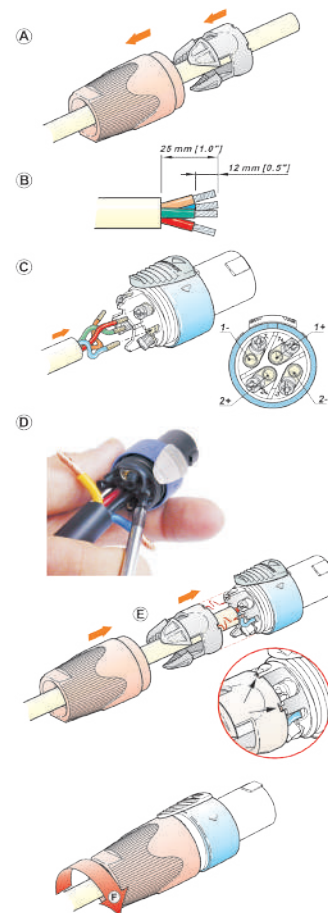

SPEAKON

- A) Inserire il passacavo sul cavo.
- B) Preparare il cavo come indicato.

Importante: rispettare le lunghezze di 25 mm e 12 mm.

- C) Inserire i conduttori all'interno dei terminali e serrare le viti.
- D) Per un veloce assemblaggio specialmente con cavi di grandi dimensioni prima inserire i contatti 1+ e 2+ dopodichè gli altri contatti 1- e 2-.
- E) Inserire la pinza sul corpo connettore.

Importante: allineare le estremità della pinza ai punti di contatto predisposti.

- F) Terminare l'installazione serrando il corpo connettore con il passacavo.

SPEAKON

- A) Place bushing and chuck over cable.
- B) Prepare cable as shown.

Important is the stripping length of 25 mm and 12 mm.

- C) Insert wires into terminals and secure clamp terminals with screw driver.
- D) For easy wiring especially on big cables, first screw on the inner contacts 1+ and 2+ and afterwards the outer contacts 1- and 2-!
- E) Push chuck up to housing.

Important: Align the chuck by positioning the nose into the recess.

- F) Tighten the bushing



Proel Connector
NEUTRIK Connector
Rean Connector



MONO/STEREO JACK CABLE MOUNT PLUGS CONNECTORS

NEUTRIK®

NP2XAU - NP2RXAU

- Connettore jack Mono NEUTRIK per strumenti che rappresenta la soluzione perfetta per i cambi di strumenti come chitarre elettriche e può evitare i classici e noiosi rumori tipicamente associati all'inserimento e al disinserimento del cavo da uno strumento collegato all'amplificatore. Disponibile nella versione dritta (NP2XAU) e ad angolo (NP2RXAU).
- NEUTRIK, new Professional Ø 6.3 mm "SILENT" Mono jack plug, gold plated contacts, red rubber overlay, silent switch. Special version of 2 pole plug with integrated switch which automatically mutes (shorts) a guitar cable to avoid annoying pops and squeals when hot swapping guitars. Available models: straight (NP2XAU) and right angle (NP2RXAU).



NP2X - NP2XBAG - NP2XB

- Jack Mono professionale NEUTRIK Ø 6.3 mm - 1/4" dal minimo ingombro (Ø 14.5 mm). Contatto realizzato in un unico pezzo senza rivetti e con esclusivo sistema di ritenzione del cavo. Disponibile nella versione nickel (NP2X), cromato nero con contatti argento (NP2XBAG) e cromato nero con contatti dorati (NP2XB).
- NEUTRIK, new Professional Ø 6.3 mm Mono jack plug, nickel contacts, extra slim design (shell with a width of 14.5 mm) for best handling convenience. Precision machined one-piece contacts, improved chuck type strain relief for reliable cable retention. Available with nickel shell (NP2X), chrome black shell (NP2XBAG) and chrome black shell with gold contacts (NP2XB).



NP3X - NP3XBAG - NP3XB

- Jack Stereo professionale NEUTRIK Ø 6.3 mm. - 1/4" con le stesse caratteristiche dell'NP2X. Disponibile nella versione nickel (NP3X), cromato nero con contatti argento (NP3XBAG) e cromato nero con contatti dorati (NP3XB).
- NEUTRIK, new Professional Ø 6.3 mm Stereo jack plug, nickel contacts, extra slim design (shell with a width of 14.5 mm) for best handling convenience. Same features as per NP2X. Available with nickel shell (NP2X), chrome black shell (NP3XBAG) and chrome black shell with gold contacts (NP3XB).



NP2RX - NP2RXBAG

- Jack Mono professionale ad angolo NEUTRIK Ø 6.3 mm - 1/4" dal minimo ingombro (Ø 14.5 mm). Contatto realizzato in un unico pezzo senza rivetti e con esclusivo sistema di ritenzione del cavo. Disponibile nella versione nickel (NP2RX) e cromato nero con contatto argento (NP2RXBAG).
- NEUTRIK, new Professional Ø 6.3 mm Right angle Mono jack plug, nickel contacts, extra slim design (shell with a width of 14.5 mm) for best handling convenience. Precision machined one-piece contacts, improved chuck type strain relief for reliable cable retention. Available with nickel shell (NP2RX) and chrome black shell (NP2RXBAG).



NP2C

- Jack Mono professionale NEUTRIK Ø 6.3 mm - 1/4". Contatto realizzato in un unico pezzo senza rivetti e con esclusivo sistema di ritenzione del cavo. Disponibile nella versione nickel con contatti argento (NP2C).
- NEUTRIK Ø 6.3 mm - 1/4" professional mono jack male plug, all metal, no rivets and with the exclusive cable clamping system, 2 poles.



NP3C

- Jack Stereo professionale NEUTRIK Ø 6.3 mm. - 1/4" con le stesse caratteristiche dell'NP2C. Disponibile nella versione nickel con contatti argento. (NP3C).
- NEUTRIK Ø 6.3 mm - 1/4" professional stereo jack male plug, all metal, no rivets and with the exclusive cable clamping system, 3 poles.



NTP3RC

- Jack Stereo professionale NEUTRIK Ø 3.5 mm - 1/8" interamente in metallo, senza viti e con l'esclusivo serracavo, 3 poli.
- NEUTRIK, new Professional Ø 3.5 mm Right angle Stereo jack plug, solder termination, chuck type strain relief, bushing. Available with nickel housing and nickel contacts (NTP3RC).



STEREO JACK CABLE MOUNT PLUGS/SOCKETS Ø 3.5 MM CONNECTORS

NEUTRIK®

NYS231 - NYS231BG

• Jack Stereo Ø 3.5 - 1/8" mm REAN, interamente in metallo. Disponibile nella versione nickel (NYS231) e cromato nero con contatti dorati (NYS231BG).

• REAN, new Ø 3.5 mm Stereo jack plug. Precision machined contacts. Available with nickel shell and nickel contacts (NYS231) and chrome black shell with gold plated contacts (NYS231BG).



NYS240 - NYS240BG

• Jack Stereo femmina volante Ø 3.5 mm - 1/8" REAN, interamente in metallo. Disponibile nella versione nickel (NYS240) e cromato nero con contatti dorati (NYS240BG).

• REAN, new Ø 3.5 mm Stereo jack socket. Precision machined contacts. Available with nickel shell and nickel contacts (NYS240) and chrome black shell with gold plated contacts (NYS240BG).

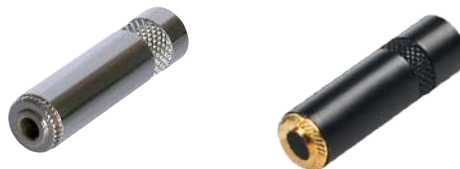

RCA CABLE MOUNT CONNECTORS

NYS3732

• Spina volante RCA REAN, con contatti dorati e con corpo interamente in metallo. Colore rosso.

• REAN, RCA plug with gold plated contacts, black chromium shell, chuck type strain relief. Red ring colour.



NYS3730

• Spina volante RCA REAN, con contatti dorati e con corpo interamente in metallo. Colore nero.

• REAN, RCA plug with gold plated contacts, black chromium shell, chuck type strain relief. Black ring colour.



ETHERCON CONNECTORS

CONNECTORS

NEUTRIK®

NE8MX - NE8MXB

• Guscio NEUTRIK per connettore RJ45 per la trasmissione dati (sia 10Base-T sia 100Base-T) in ambienti estremi e permette il montaggio di cavi preassemblati con connettori RJ45 convenzionali. Utilizzato anche per la trasmissione dati per il protocollo luci DMX. Disponibile nelle versioni con corpo colore nickel (NE8MX) e colore nero (NE8MXB). ATTENZIONE: connettore RJ45 non incluso nella confezione.

• *NEUTRIK cable mount RJ45 connector carrier for data transmission (both 10Base-T and 100Base-T) in extreme environments and allows the installation of pre-assembled cables with conventional RJ45 plugs. It is also used for the data transmission of DMX lighting protocol. Available with nickel body color (NE8MX) and black (NE8MXB). CAUTION: RJ45 plug is not included.*



NE8MX6T - NE8MX6BT

• Connettore etherCON CAT6A, con sistema di connessione a crimpare conforme alla norme ISO/IEC 11801 e TIA/EIA 568-C.2. Utilizzabile con cavi AWG26/1 - AWG24/1 (conduttore solido), oppure AWG27/7 - AWG24/7. Passacavo adatto per cavi con diametro da 7 a 9,5 mm. Il connettore è accoppiabile con la gamma Ethercon CAT5 preesistente. Disponibile nelle versioni: nickelato (NE8MX6T) e nero (NE8MX6BT). Attenzione! Non utilizzabile con i connettori da pannello NE8FDY-C6 ed NE8FDY-C6-B.

• *etherCON CAT6A self-termination cable connector complying with ISO/IEC 11801 and TIA/EIA 568-C.2 standards. It can be used with AWG26/1 - AWG24/1 (solid) or AWG27/7 - AWG24/7 (stranded) cables. The connector is suitable for a cable diameter range of 7 mm to 9.5 mm. The connector is intermateable with the existing etherCON CAT5 range. Available models: Nickel plated (NE8MX6T) and black (NE8MX6BT). Attention! Does not intermate with the CAT6 chassis connectors NE8FDY-C6 and NE8FDY-C6-B.*



NE8MX1 - NE8MXB1

• Guscio NEUTRIK con le stesse caratteristiche dell'NE8MC, con passacavo speciale, adatto a cavi con diametro da 3,5 fino a 8 mm. Da utilizzare solo per cavi non preassemblati. Disponibile nelle versioni con corpo colore nickel (NE8MX1) e colore nero (NE8MXB1). ATTENZIONE: connettore RJ45 non incluso nella confezione.

• *NEUTRIK cable mount connector carrier with same features of NE8MC, with special boot suitable for cable diameters from 3.5 p to 8 mm. For non preassembled cables only. Available with nickel finishing body (NE8MX1) and black finishing body (NE8MXB1). ATTENTION: RJ45 plug is not included.*



NE8FDXY6 - NE8FDXY6B

• Connettore etherCON CAT6A da pannello con flangia tipo "D" con sistema di connessione a crimpare conforme alla norme ISO/IEC 11801 e TIA/EIA 568-C.2. Il connettore è accoppiabile con la gamma Ethercon CAT5 preesistente. Disponibile nelle versioni: nickelato (NE8FDXY6) e nero (NE8FDXY6B). Attenzione! Non utilizzabile con i connettori volanti NE8MC6-MO e con i cavi NKE6S.

• *D-shape panel mount etherCON CAT6A self-termination connector complying with ISO/IEC 11801 and TIA/EIA 568-C.2 standards. The connector is intermateable with the existing etherCON CAT5 range. Available models: Nickel plated (NE8FDXY6) and black (NE8FDXY6B). Attention! Does not intermate with CAT6 cable connector NE8MC6-MO and NKE6S cables.*

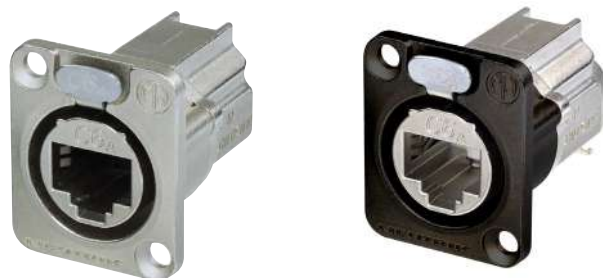

NE8FDV - NE8FDP

• Presa da pannello NEUTRIK RJ45 per la trasmissione dati (sia 10Base-T sia 100Base-T) in ambienti estremi. Utilizzato per tutti i cavi CAT 5, questo connettore viene utilizzato anche per il protocollo luci DMX. Provvista di tasto PUSH, contatti orizzontali per connessioni dirette con cavo CAT 5 (NE8FDV), connettore RJ45/RJ45 passante (NE8FDP).

• *NEUTRIK RJ45 panel mount female receptacle for data transmission (both 10Base-T and 100Base-T) in harsh environments. Used for all CAT 5 cables, this connector is also employed for the DMX lighting protocol. Equipped with latch, horizontal contacts for direct connections with CAT 5 cable (NE8FDV), RJ45/RJ45 feedthrough connector (NE8FDP).*



NE8FF

• Accoppiatore etherCON RJ45 per realizzare prolunghe di cavi. Utilizzabile con i connettori NE8MC o qualsiasi plug RJ45 standard. Dotato del comprovato sistema di blocco NEUTRIK. Disponibile nel colore nero.

• *etherCON RJ45 feedthrough coupler for cable extensions. Accommodates NE8MC* or any standard RJ45 plug. The adapter offers the approved latch lock system. Available in black finishing.*



XLR CABLE MOUNT FEMALE/MALE CONNECTORS

CONNECTORS

NEUTRIK®

NC3FXX - NC3FXXBAG - NC3FXXB



- Presa volante NEUTRIK XLR, 3 poli con sistema di contatto a gabbia che aumenta la conduttività e nuovo "ferma stagno" per facilitare la saldatura. Blocca cavo migliorato, aumenta la forza di ritenzione e rende più semplice e veloce l'assemblaggio. Disponibile nella versione nickel con contatti argento (NC3FXX), cromato nero con contatti argento (NC3FXXBAG) e cromato nero con contatti dorati (NC3FXXB).
- NEUTRIK, new Professional XLR 3-pole female cable connector with new features which make it more reliable, easier to assemble and improves contact integrity as well cable strain relief. Additional ground spring contacts for better shell ground continuity. Available with nickel shell with silver contacts (NC3FXX), chrome black shell with silver contacts (NC3FXXBAG) and chrome black shell with gold contacts (NC3FXXB).



NC3MXX - NC3MXXBAG - NC3MXXB



- Spina volante NEUTRIK XLR, 3 poli con nuovo sistema di bloccaggio che aumenta la tenuta e la durata del connettore. Blocca cavo migliorato, aumenta la forza di ritenzione e rende più semplice e veloce l'assemblaggio. Disponibile nella versione nickel con contatti argento (NC3MXX), cromato nero con contatti argento (NC3MXXBAG) e cromato nero con contatti dorati (NC3MXXB).
- NEUTRIK, new Professional XLR 3-pole male cable connector with new features which make it more reliable, easier to assemble and improves contact integrity as well cable strain relief. Improved locking recess without "window", more stringent housing increases durability. Available with nickel shell with silver contacts (NC3MXX), chrome black shell with silver contacts (NC3MXXBAG) and chrome black shell with gold contacts (NC3MXXB).



NC5FXX



- Connettore con le stesse caratteristiche dell'NC3FXX ma a 5 poli. Disponibile nella versione nickel con contatti argento (NC5FXX).
- NEUTRIK, new Professional XLR 5-pole female cable connector with same features as per NC3FXX. Available with nickel housing and silver contacts (NC5FXX).



NC5MXX



- Connettore con le stesse caratteristiche dell'NC3MXX ma a 5 poli. Disponibile nella versione nickel con contatti argento (NC5MXX).
- NEUTRIK, new Professional XLR 5-pole male cable connector with same features as per NC3MXX. Available with nickel housing and silver contacts (NC5MXX).



NC3FRX



- Presa volante NEUTRIK XLR, 3 poli ad angolo 90° con le stesse caratteristiche dell'NC3FXX. Inoltre prevede 5 posizioni selezionabili di uscita del cavo nel senso della rotazione. Disponibile nella versione nickel con contatti argento (NC3FRX).
- NEUTRIK, new Professional XLR 3-pole right angle female connector with same features as per NC3FXX and with 5 selectable cable outlet positions. Available with nickel housing and silver contacts (NC3FRX).



NC3MRX



- Spina volante NEUTRIK XLR, 3 poli ad angolo 90° con le stesse caratteristiche dell'NC3MXX. Inoltre prevede 5 posizioni selezionabili di uscita del cavo nel senso della rotazione. Disponibile nella versione nickel con contatti argento (NC3MRX).
- NEUTRIK, new Professional XLR 3-pole right angle male connector with same features as per NC3MXX and with 5 selectable cable outlet positions. Available with nickel housing and silver contacts (NC3MRX).



XLR PANEL MOUNT FEMALE/MALE CONNECTORS

CONNECTORS

NEUTRIK®

NC3FDLX

- Presa da pannello NEUTRIK XLR 3P in alluminio anodizzato, migliorata in affidabilità e robustezza. Contatto duplex di massa, schermatura dalle radiofrequenze. Corpo nichelato e contatti argento.
- NEUTRIK, new Professional D-shape XLR 3-pole female panel mount connector. The new DLX series features a compact all metal housing with an ingenious duplex ground contact, which offers excellent RF protection and shielding. Available with nickel housing and silver contacts (NC3FDLX).



NC3MDLX

- Spina da pannello NEUTRIK XLR 3P in alluminio anodizzato, migliorata in affidabilità e robustezza. Contatto duplex di massa, schermatura dalle radiofrequenze. Corpo nichelato e contatti argento.
- NEUTRIK, new Professional D-shape XLR 3-pole male panel mount connector. The new DLX series features a compact all metal housing with an ingenious duplex ground contact, which offers excellent RF protection and shielding. Available with nickel housing and silver contacts (NC3MDLX).



NC5FDLX

- Presa da pannello NEUTRIK XLR 5P con le stesse caratteristiche dell'NC3FDLX.
- NEUTRIK, new Professional D-shape XLR 5-pole female panel mount connector, with same features as per NC3FDLX. Available with nickel housing and silver contacts (NC5FDLX).



NC5MDLX

- Spina da pannello NEUTRIK XLR 5P con le stesse caratteristiche dell'NC3MDLX.
- NEUTRIK, new Professional D-shape XLR 5-pole male panel mount connector, with same features as per NC3MDLX. Available with nickel housing and silver contacts (NC5MDLX).



SPEAKON CABLE MOUNT CONNECTORS

NL2FX

- Presa volante NEUTRIK "SPEAKON" 2 poli - +1/-1. Manicotto con ingresso per cavi 0.6 - 10 mm. Corrente di esercizio: 40A continui per contatto (50A per segnale audio).
- 2 pole cable connector, chuck type strain relief, intermates with 4-pole chassis connector and makes contact with +1/-1.



NL4FX

- Presa volante NEUTRIK "SPEAKON" con nuova molla ergonomica di aggancio rapido, manicotto con ingresso per cavi Ø 5 - 12 mm - 50 A continui per contatto, 4 poli.
- NEUTRIK "SPEAKON" cable mount female socket with new ergonomic fast retention spring, back shell for Ø 5 - 12 mm cables - 50 A continuous per contact, 4 poles.



NL4FC

- Presa volante NEUTRIK "SPEAKON" con molla di aggancio; manicotto con ingresso per cavi Ø 5 - 12 mm - 30 A continui per contatto, 4 poli.
- NEUTRIK, new Professional "SPEAKON" 4-pole female cable mount connector with Cable strain relief for 5 - 15 mm cable O.D. User friendly latch design for easy handling. 30A rms current rating.



NL8FC

- Presa volante NEUTRIK "SPEAKON" con molla di aggancio, manicotto con ingresso per cavi Ø 10 - 21 mm - 30 A continui per contatto, 8 poli.
- NEUTRIK "SPEAKON" cable mount female socket with retention spring, back shell for Ø 10 - 21 mm. cables - 30 A continuous per contact, 8 poles.



SPEAKON PANEL MOUNT CONNECTORS & ADAPTER CONNECTORS

NEUTRIK®

NL2MP

- Spina da pannello NEUTRIK "SPEAKON" con piccola flangia quadrata a tenuta d'aria, 2 poli.
- NEUTRIK "SPEAKON" panel mount male receptacle with small square flange, air tight, 2 poles.



NL4MP

- Spina da pannello NEUTRIK "SPEAKON" con piccola flangia quadrata a tenuta d'aria, 4 poli.
- NEUTRIK "SPEAKON" panel mount male receptacle with small square flange, air tight, 4 poles.



NL8MPR

- Spina da pannello NEUTRIK "SPEAKON" con flangia quadrata, 8 poli.
- NEUTRIK "SPEAKON" panel mount male receptacle with square flange, 8 poles.



NL4MMX

- Adattatore di giunzione NEUTRIK "SPEAKON" a 4 poli per collegare insieme due NL4FC e/o due NL4FX (ideale per prolunghe di cavi).
- Neutrik "SPEAKON" 4-pole adapter to link two NL4FC and/or two NL4FX together (suitable for cable extensions).



POWERCON CABLE MOUNT & PANEL MOUNT CONNECTORS

NAC3FCA

- Presa volante NEUTRIK "POWERCON" di potenza 20A, blue, "POWER IN" system, 3 poli.
- NEUTRIK "Powercon" cable mount 20A female power socket, blue, "POWER IN" system, 3 poles.



NAC3FCB

- Presa volante NEUTRIK "POWERCON" di potenza 20A, grigio, "POWER OUT" system, 3 poli.
- NEUTRIK "Powercon" cable mount 20A female power socket, grey, "POWER OUT" system, 3 poles.



NAC3MPA

- Spina da pannello NEUTRIK "powercon" di potenza 20A, blue, "POWER IN" system, 3 poli.
- NEUTRIK "Powercon" panel mount 20A male power receptacle, blue, "POWER IN" system, 3 poles.



NAC3MPB

- Spina da pannello NEUTRIK "powercon" di potenza 20A, grigio, "POWER OUT" system, 3 poli.
- NEUTRIK "Powercon" panel mount 20A male power receptacle, grey, "POWER OUT" system, 3 poles.



POWERCON TRUE1 CABLE MOUNT & PANEL MOUNT CONNECTORS

CONNECTORS

NEUTRIK®

NAC3FXWTOP

- Presa volante NEUTRIK "powerCON TRUE1" di potenza 20A con contatti terminali a vite. Resistenza alla polvere ed all'acqua con grado di protezione IP65 quando connesso. Colore giallo / nero, "power in" system, 3 poli.
- NEUTRIK "powerCON TRUE1" 20A locking female cable connector, with screw terminals. Dust and water resistant according to IP65 in mated condition. Black/yellow color, "power in" system, 3 poles.



NAC3MXWTOP

- Spina volante NEUTRIK "powerCON TRUE1" di potenza 20A con contatti terminali a vite. Resistenza alla polvere ed all'acqua con grado di protezione IP65 quando connesso. Colore giallo / nero, "power-out" system, 3 poli.
- NEUTRIK "powerCON TRUE1" 20A locking male cable connector, with screw terminals. Dust and water resistant according to IP65 in mated condition. Black/yellow color, "power-out" system, 3 poles.



NAC3MPXTOP

- Spina da pannello NEUTRIK "powerCON TRUE1" di potenza 20A con contatti terminali piatti da 1/4". Grado di protezione IP65 quando connesso. Colore giallo / nero, "power-in" system, 3 poli.
- NEUTRIK "powerCON TRUE1" 20A locking male panel mount connector, 1/4" flat tab terminals. Water resistant according to IP65 in mated condition. Black/yellow color, "power in" system, 3 poles.



NAC3FPXTOP

- Presa da pannello NEUTRIK "powerCON TRUE1" di potenza 20A con contatti terminali piatti da 1/4". Grado di protezione IP65 quando connesso. Colore giallo / nero, "power-in" system, 3 poli.
- NEUTRIK "powerCON TRUE1" 20A locking female panel mount connector, 1/4" flat tab terminals. Water resistant according to IP65 in mated condition. Black/yellow color, "power in" system, 3 poles.



NAC3FPXSTTOP

- Presa da pannello NEUTRIK "powerCON TRUE1" di potenza 20A con contatti terminali a vite. Grado di protezione IP65 quando connesso. Colore giallo / nero, "power-in" system, 3 poli.
- NEUTRIK "powerCON TRUE1" 20A locking female panel mount connector, with screw terminals. Water resistant according to IP65 in mated condition. Black/yellow color, "power in" system, 3 poles.



NAC3PXTOP

- Connettore combinato - spina/presa - da pannello NEUTRIK "powerCON TRUE1" di potenza 20A con contatti terminali piatti da 1/4". Grado di protezione IP65 quando connesso. Colore giallo / nero, "power-in / power-out" system, 3 poli.
- NEUTRIK "powerCON TRUE1" 20A locking combined male / female panel mount connector, with 1/4" flat tab terminals. Water resistant according to IP65 in mated condition. Black/yellow color, "power-in / power-out" system, 3 poles.



SCNACMPX

- Copertura di protezione NEUTRIK per connettore spina da pannello powerCON TRUE1 - NAC3MPX. CONNETTORE NON INCLUSO.
- NEUTRIK sealing cover for powerCON TRUE1 male chassis connector - NAC3MPX. CONNECTOR NOT INCLUDED.



SCNACFPX

- Copertura di protezione NEUTRIK per connettori presa da pannello powerCON TRUE1 - NAC3FPX / NAC3FPXST. CONNETTORE NON INCLUSO.
- NEUTRIK sealing cover for powerCON TRUE1 female chassis connectors - NAC3FPX / NAC3FPXST. CONNECTOR NOT INCLUDED.



SCNACPX

- Copertura di protezione NEUTRIK per connettore combinato da pannello powerCON TRUE1 - NAC3PX.
- NEUTRIK sealing cover for powerCON TRUE1 duplex chassis connector - NAC3PX.



MONO JACK CABLE MOUNT PLUGS Ø 6.3 MM CONNECTORS

S210

- Jack mono Ø 6.3 mm.- 1/4" con manicotto in ottone nichelato e molla passacavo flessibile Ø 7 mm. Colore: Argento.
- Mono jack male plug Ø 6.3 mm.- 1/4" with nickel plated brass shell and Ø 7 mm flexible cable spring. Colour: Silver.



S210BK

- Jack Mono Ø 6.3 mm.- 1/4" con manicotto in ottone nichelato nero e molla passacavo flessibile Ø 7 mm. Colore: nero. Confezione standard: 5 pezzi.
- Mono jack male plug Ø 6.3 mm.- 1/4" with nickel plated brass shell and Ø 7 mm. flexible cable spring. Colour: Black. Master pack: 5 pcs.



S230

- Jack Mono Ø 6.3 mm.- 1/4" professionale con manicotto in ottone nichelato e molla passacavo flessibile Ø 7.3 mm. Confezione standard: 5 pezzi.
- Professional mono jack male plug Ø 6.3 mm.- 1/4" with nickel plated brass shell and Ø 7.3 mm. flexible cable spring. Master pack: 5 pcs.



S232

- Jack Mono Ø 6.3 mm.- 1/4" professionale con manicotto in ottone nichelato, contatti dorati e molla passacavo flessibile Ø 7.3 mm. Confezione standard: 5 pezzi.
- Professional mono jack male plug Ø 6.3 mm.- 1/4" with nickel plated brass shell, gold plated contacts and Ø 7.3 mm. flexible cable spring. Master pack: 5 pcs.



S320

- Jack Mono Ø 6.3 mm.- 1/4" professionale, contatti dorati, manicotto in ottone nichelato argentato e molla passacavo flessibile Ø 7.3 mm. Confezione standard: 5 pezzi.
- Professional mono "Jumbo" jack male plug Ø 6.3 mm.- 1/4", gold plated contacts, nickel plated silver plated brass shell and Ø 7.3 mm. flexible cable spring. Master pack: 5 pcs.



S400

- Jack Mono "Mini-Jumbo" Ø 6.3 mm.- 1/4" professionale con manicotto in ottone nichelato e molla passacavo flessibile Ø 9 mm. Confezione standard: 5 pezzi.
- Professional mono "Mini-Jumbo" jack male plug Ø 6.3 mm.- 1/4", nickel plated brass shell and Ø 9 mm. flexible cable spring. Master pack: 5 pcs.



S500

- Jack Mono "Jumbo" Ø 6.3 mm.- 1/4" professionale con manicotto in ottone nichelato e molla passacavo flessibile Ø 12 mm. Confezione standard: 4 pezzi.
- Professional mono "Jumbo" jack male plug Ø 6.3 mm.- 1/4" with nickel plated shell and Ø 12 mm. flexible cable spring. Master pack: 2 pcs.



S290BK

- Jack Mono Ø 6.3 mm.- 1/4" con contatti dorati, manicotto in gomma naturale e pinza serracavo interna in nylon, passacavo Ø 7.5 mm. Colore: nero. Confezione standard: 5 pezzi.
- Mono jack male plug Ø 6.3 mm.- 1/4" with gold plated contacts, natural rubber sleeve and inner nylon cable clamping system, Ø 7.5 mm. cable outlet. Colour: Black. Master pack: 5 pcs.



S2C

- Jack Mono Ø 6.3 mm.- 1/4" professionale, manicotto in alluminio pressofuso nichelato e passacavo in PVC nero Ø 7.5 mm. Confezione standard: 5 pezzi.
- Professional mono jack male plug Ø 6.3 mm.- 1/4", nickel plated die cast aluminium shell and Ø 7.5 mm. black PVC cable outlet. Master pack: 5 pcs.



S2CBK

- Jack Mono Ø 6.3 mm.- 1/4" professionale, manicotto in alluminio pressofuso nichelato nero e passacavo in PVC nero Ø 7.5 mm. Confezione standard: 5 pezzi.
- Professional mono jack male plug Ø 6.3 mm.- 1/4", black nickel plated die cast aluminium shell and Ø 7.5 mm. black PVC cable outlet. Master pack: 5 pcs.



MONO JACK CABLE MOUNT PLUGS Ø 6.3 MM CONNECTORS

S2CPROBK

- Jack Mono professionale Ø 6,3mm-1/4", punta dorata, manicotto in alluminio pressofuso nichelato con ghiera stringicavo in alluminio nichelato e pinza interna in nylon. Colore anello: nero. Confezione 5 pezzi.
- Professional mono jack male plug Ø 6.3 mm.- 1/4", gold plated tip, nickel plated die cast aluminium shell with nickel plated aluminium coupling ring and inner nylon cable clamping system. Ring colour: Black. Master pack: 5 pcs.



S2CPRON

- Jack Mono professionale Ø 6,3mm-1/4", punta dorata, manicotto e ghiera stringicavo in alluminio pressofuso di colore nero e pinza interna in nylon. Confezione 5 pezzi.
- Professional mono jack male plug Ø 6.3 mm.- 1/4", gold plated tip, nickel plated die cast aluminium shell and coupling ring, inner nylon cable clamping system. Master pack: 5 pcs.



S2CPROBL

- Jack Mono professionale Ø 6,3mm-1/4", punta dorata, manicotto in alluminio pressofuso nichelato con ghiera stringicavo in alluminio nichelato e pinza interna in nylon. Colore anello: blue. Confezione standard: 5 pezzi.
- Professional mono jack male plug Ø 6.3 mm.- 1/4", gold plated tip, nickel plated die cast aluminium shell with nickel plated aluminium coupling ring and inner nylon cable clamping system. Ring colour: Blue. Master pack: 5 pcs.



S2CPRORD

- Jack Mono professionale Ø 6,3mm-1/4", punta dorata, manicotto in alluminio pressofuso nichelato con ghiera stringicavo in alluminio nichelato e pinza interna in nylon. Colore anello: rosso. Confezione standard: 5 pezzi.
- Professional mono jack male plug Ø 6.3 mm.- 1/4", gold plated tip, nickel plated die cast aluminium shell with nickel plated aluminium coupling ring and inner nylon cable clamping system. Ring colour: Red. Master pack: 5 pcs.



S4CPRO

- Jack Mono professionale Ø 6,3mm-1/4", manicotto in alluminio pressofuso nichelato e contatti argentati. Confezione standard : 5 pezzi.
- Professional Ø 6.3 mm - 1/4" mono jack plug, with die cast aluminium shell, nickel plated contacts and Ø 7.3 mm flexible cable spring. Master pack: 5 pc.



STEREO JACK CABLE MOUNT PLUGS Ø 6.3 MM CONNECTORS

S215

- Jack Stereo Ø 6.3 mm.- 1/4" con manicotto in ottone nichelato e molla passacavo flessibile Ø 7 mm. Confezione standard: 5 pezzi.
- Stereo jack male plug Ø 6.3 mm.- 1/4" with nickel plated brass body and Ø 7 mm. flexible cable spring. Master pack: 5 pcs.



S215BK

- Jack Stereo Ø 6.3 mm.- 1/4" con manicotto in ottone nichelato nero e molla passacavo flessibile Ø 7 mm. Colore: nero. Confezione standard: 5 pezzi.
- Stereo jack male plug Ø 6.3 mm.- 1/4" with black nickel plated brass shell and Ø 7 mm. flexible cable spring. Colour: black. Master pack: 5 pcs.

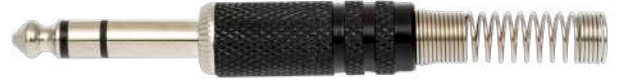

S230S

- Jack Stereo Ø 6.3 mm.- 1/4" con manicotto in ottone nichelato e molla passacavo flessibile Ø 7.3 mm. Confezione standard: 5 pezzi.
- Stereo jack male plug Ø 6.3 mm.- 1/4" with nickel plated brass shell and Ø 7.3 mm. flexible cable spring. Master pack: 5 pcs.



S232S

- Jack Stereo Ø 6.3 mm.- 1/4" professionale con manicotto in ottone nichelato e molla passacavo flessibile Ø 7.3 mm. Contatti dorati. Confezione standard: 5 pezzi.
- Professional stereo jack male plug Ø 6.3 mm.- 1/4" with nickel plated brass shell and Ø 7.3 mm. flexible cable spring. Gold plated contacts. Master pack: 5 pcs.



S320S

- Jack Stereo Ø 6.3 mm.- 1/4" professionale, contatti dorati, manicotto in ottone nichelato argentato e molla passacavo flessibile Ø 7.3 mm. Confezione standard: 5 pezzi.
- Professional stereo jack male plug Ø 6.3 mm.- 1/4", gold plated contacts, nickel plated silver plated brass shell and Ø 7.3 mm. flexible cable spring. Master pack: 5 pcs.



S295BK

- Jack Stereo Ø 6.3 mm.- 1/4" con contatti dorati, manicotto in gomma naturale e pinza stringicavo interna in nylon, passacavo Ø 7.5 mm. Colore: nero. Confezione standard: 5 pezzi.
- Professional stereo jack male plug Ø 6.3 mm.- 1/4" with gold plated contacts, natural rubber sleeve and inner nylon cable clamping system, Ø 7.5 mm. cable outlet. Colour: Black. Master pack: 5 pcs.



S3C

- Jack Stereo Ø 6.3 mm.- 1/4" professionale, manicotto in alluminio pressofuso nichelato e passacavo in PVC nero Ø 7.5 mm. Confezione standard: 5 pezzi.
- Professional stereo jack male plug Ø 6.3 mm.- 1/4", nickel plated die cast aluminium shell and Ø 7.5 mm. black PVC cable outlet. Master pack: 5 pcs.



S3CBK

- Jack Stereo Ø 6.3 mm.- 1/4" professionale, manicotto in alluminio pressofuso nichelato nero e passacavo in PVC nero Ø 7.5 mm. Confezione standard: 5 pezzi.
- Professional stereo jack male plug Ø 6.3 mm.- 1/4", black nickel plated die cast aluminium shell and Ø 7.5 mm. black PVC cable outlet. Master pack: 5 pcs.



S3CPROBK

- Jack Stereo professionale 6.3mm-1/4", punta dorata, manicotto in alluminio pressofuso nichelato con ghiera stringicavo in alluminio nichelato e pinza interna in nylon. Colore anello: nero. Confezione standard: 5 pezzi.
- Professional stereo jack male plug 6.3 mm.- 1/4", gold plated tip, nickel plated die cast aluminium shell with nickel plated aluminium coupling ring and inner nylon cable clamping system. Ring colour: black. Master pack: 5 pcs.



S3CPRON

- Jack Stereo professionale Ø 6,3mm-1/4", punta dorata, manicotto e ghiera stringicavo in alluminio pressofuso di colore nero e pinza interna in nylon. Confezione 5 pezzi.
- Professional stereo jack male plug Ø 6.3 mm.- 1/4", gold plated tip, nickel plated die cast aluminium shell and coupling ring, inner nylon cable clamping system. Master pack: 5 pcs.



S5CPRO

- Jack Stereo Ø 6.3 mm.- 1/4" professionale, manicotto in alluminio pressofuso nichelato e passacavo in PVC nero Ø 7.5 mm. Colore anello terminale: blu. Confezione standard: 5 pezzi.
- Professional Ø 6.3 mm - 1/4" Stereo jack plug, with die cast aluminium shell, nickel plated contacts and Ø 7.3 mm flexible cable spring. Master pack: 5 pcs.



MONO & STEREO RIGHT ANGLE JACK CABLE MOUNT PLUGS Ø 6.3 MM CONNECTORS

S240

- Jack Mono professionale Ø 6.3 mm. - 1/4" ad angolo 90° interamente in metallo, senza viti e con l'esclusivo serracavo. Confezione standard: 5 pezzi.
- Professional Ø 6.3 mm. - 1/4" mono right-angled jack male plug, all metal, no rivets and with the exclusive cable clamping system. Master pack: 5 pcs.



S240S

- Jack Stereo professionale Ø 6.3 mm. - 1/4" ad angolo 90° interamente in metallo, senza viti e con l'esclusivo serracavo. Confezione standard: 5 pezzi.
- Professional Ø 6.3 mm. - 1/4" stereo right-angled jack male plug, all metal, no rivets and with the exclusive cable clamping system. Master pack: 5 pcs.



S242

- Jack Mono professionale Ø 6.3 mm. - 1/4", angolare a 90° con contatti dorati, manicotto in alluminio argentato e molla passacavo flessibile Ø 7.3 mm. Confezione standard: 5 pezzi.
- Professional mono jack male plug Ø 6.3 mm. - 1/4", right-angled with gold plated contacts, silver plated aluminium shell and Ø 7.3 mm flexible cable spring. Master pack: 5 pcs.



S242S

- Jack Stereo professionale Ø 6.3 mm. - 1/4" professionale, angolare a 90° con contatti dorati, manicotto in alluminio argentato e molla passacavo flessibile Ø 7.3 mm. Confezione standard: 5 pezzi.
- Professional stereo jack male plug Ø 6.3 mm. - 1/4", right-angled with gold plated contacts, silver plated aluminium shell and Ø 7.3 mm flexible cable spring. Master pack: 5 pcs.



S2RCS

- Jack mono professionale Ø 6,3mm.-1/4" ad angolo 90° interamente in metallo, con pressacavo di sicurezza in metallo. Confezione standard : 5 pezzi.
- Professional mono right-angled jack male plug Ø 6.3 mm. - 1/4", all metal, with security metal cable clamping system. Master pack: 5 pcs.



S4RCS

- Jack mono professionale ad angolo 90° Ø 6,3mm.-1/4" interamente in metallo , molla passacavo flessibile Ø 7.3 mm. Confezione standard : 5 pezzi.
- Professional Ø 6.3 mm - 1/4" right angle mono jack plug, with die cast aluminium shell, nickel plated contacts and Ø 7.3 mm flexible cable spring. Master pack: 5 pcs.



S220

- Jack mono Ø 6.3 mm.-1/4" angolare a 90°, corpo nichelato. Confezione standard: 5 pezzi.
- Mono right-angled jack male plug Ø 6.3 mm. - 1/4", nickel plated shell. Master pack: 5 pcs.



MONO & STEREO JACK CABLE/PANEL MOUNT SOCKETS Ø 6.3 MM CONNECTORS

P2C

- Presa volante jack stereo Ø 6.3 mm.-1/4" con manicotto in alluminio pressofuso argentato, provvisto di push di bloccaggio, pinza stringicavo interna in nylon e molla passacavo flessibile Ø 10 mm. Confezione standard: 4 pezzi.
- Cable mount stereo jack female socket Ø 6.3 mm. -1/4" with silver plated die cast aluminium shell, latch lock, inner nylon cable clamping system and Ø 10 mm flexible cable spring. Master pack: 4 pcs.



PP2C

- Presa da pannello jack Stereo Ø 6.3 mm.-1/4" in alluminio anodizzato con tasto di push. Confezione standard: 4 pezzi.
- Panel mount stereo jack female socket Ø 6.3 mm.-1/4", anodized aluminium with latch lock. Master pack: 4 pcs.

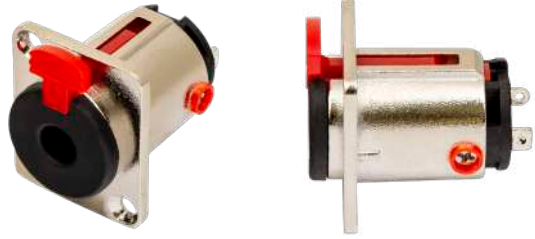

P220 - P230

- Presa volante jack mono Ø 6.3 mm.-1/4" con manicotto in ottone nichelato e molla passacavo flessibile Ø 6.5 mm. Disponibile con logo nero (P220) e logo rosso (P230). Confezione standard: 5 pezzi.
- Cable mount mono jack female socket Ø 6.3 mm. -1/4" with nickel plated brass shell and Ø 6.5 mm flexible cable spring. Available models: black shell ring (P220) and red shell ring (P230). Master pack: 5 pcs.



PP300 - PP310

- Presa da pannello jack Mono Ø 6.3 mm.-1/4" a 2 poli, contatti a saldare. Confezione: 10 pezzi.
- Panel mount mono jack female socket Ø 6.3 mm.-1/4", 2 poles, solder contacts. Master pack: 10 pcs.
- Presa da pannello jack Stereo Ø 6.3 mm.-1/4" a 3 poli, contatti a saldare. Confezione: 10 pezzi.
- Panel mount jack stereo female socket Ø 6.3 mm.-1/4", 3 poles, solder contacts. Master pack: 10 pcs.



PP300

PP310



MONO & STEREO CABLE MOUNT PLUGS/SOCKET Ø 3.5 MM

S120

- Jack Mono Ø 3.5 mm. con manicotto in ottone nichelato e molla passacavo flessibile Ø 5 mm. Confezione standard: 5 pezzi.
- Mono jack male plug Ø 3.5 mm. with nickel plated brass shell and Ø 5 mm. flexible cable spring. Master pack: 5 pcs.



S130

- Jack Stereo Ø 3.5 mm. con manicotto in ottone nichelato e molla passacavo flessibile Ø 5 mm. Confezione standard: 5 pezzi.
- Stereo jack male plug Ø 3.5 mm. with nickel plated brass shell and Ø 5 mm. flexible cable spring. Master pack: 5 pcs.



S150

- Jack Stereo Ø 3.5 mm. con manicotto in ottone dorato e molla passacavo flessibile Ø 5 mm. Confezione standard: 5 pezzi.
- Stereo jack male plug Ø 3.5 mm., with gold plated shell and contacts, Ø 5 mm. flexible cable spring. Master pack: 5 pcs.



P130

- Presa volante jack Stereo Ø 3.5 mm. con manicotto in ottone nichelato e molla passacavo flessibile Ø 5 mm. Confezione standard: 5 pezzi.
- Cable mount stereo jack female connector Ø 3.5 mm. with nickel plated brass shell and Ø 5 mm. flexible cable spring. Colour: black. Master pack: 5 pcs.



XLR CABLE MOUNT FEMALE CONNECTORS

CONNECTORS

XLR3FV - XLR5FV

- Presa volante spina XLR con manicotto nichelato. Disponibile nella versione a 3 poli (XLR3FV) ed a 5 poli (XLR5FV). Confezione standard: 4 pezzi.
- Professional XLR cable mount female socket, nickel plated shell. Available models: 3P (XLR3FV) - 5P (XLR5FV) Master pack: 4 pcs.



XLR3FVBK

- Presa volante XLR 3 poli, manicotto nero. Confezione standard: 4 pezzi.
- 3-pole XLR cable mount female socket, nickel plated black shell. Master pack: 4 pcs.



XLR3FVPRO

- Presa volante XLR professionale 3P. Manicotto in alluminio pressofuso nichelato e ghiera stringicavo in alluminio nichelato, pinza interna in nylon con molla terminale in PVC. Colore: argento. Confezione standard: 4 pezzi.
- Professional 3P XLR cable mount female socket, nickel plated die cast aluminium shell and nickel plated aluminium coupling ring, inner nylon clamping system with PVC terminal spring. Colour: silver ring. Master pack: 4 pcs.



XLR5FVPRO

- Presa volante XLR professionale 5P. Manicotto in alluminio pressofuso nichelato e ghiera stringicavo in alluminio nichelato, pinza interna in nylon con molla terminale in PVC. Colore: argento. Confezione standard: 4 pezzi.
- Professional 5P XLR cable mount female socket, nickel plated die cast aluminium shell and nickel plated aluminium coupling ring, inner nylon clamping system with PVC terminal spring. Colour: silver ring. Master pack: 4 pcs.



XLR3FVPRON - XLR5FVPRON NEW

- Presa volante XLR professionale. Manicotto e ghiera stringicavo in alluminio pressofuso di colore nero, pinza interna in nylon con molla terminale in PVC. Disponibile nella versione a 3 poli (XLR3FVPRON) ed a 5 poli (XLR5FVPRON). Confezione standard: 4 pezzi.
- Professional XLR cable mount female socket, black colour die cast aluminium shell and coupling ring, inner nylon clamping system with PVC terminal spring. Available model: 3-pole (XLR3FVPRON) - 5-pole (XLR5FVPRON). Master pack: 4 pcs.



XLR3FVPROBK

- Presa volante XLR professionale. Manicotto in alluminio pressofuso nichelato e ghiera stringicavo in alluminio nichelato, pinza interna in nylon con molla terminale in PVC. Colore anello: nero. Disponibile nella versione a 3 poli (XLR3FVPROBK). Confezione standard: 4 pezzi.
- Professional XLR cable mount female socket, nickel plated die cast aluminium shell and nickel plated aluminium coupling ring, inner nylon clamping system with PVC terminal spring. Available models: 3-pole (XLR3FVPROBK) - Ring colour: black. Master pack: 4 pcs.



XLR3FVPROBL

- Presa volante XLR professionale. Manicotto in alluminio pressofuso nichelato e ghiera stringicavo in alluminio nichelato, pinza interna in nylon con molla terminale in PVC. Colore anello: blue. Disponibile nella versione a 3 poli (XLR3FVPROBL). Confezione standard: 4 pezzi.
- Professional XLR cable mount female socket, nickel plated die cast aluminium shell and nickel plated aluminium coupling ring, inner nylon clamping system with PVC terminal spring. Available models: 3-pole (XLR3FVPROBL) Ring colour: blue. Master pack: 4 pcs.



XLR3FVPRORD

- Presa volante XLR professionale. Manicotto in alluminio pressofuso nichelato e ghiera stringicavo in alluminio nichelato, pinza interna in nylon con molla terminale in PVC. Colore anello: rosso. Disponibile nella versione a 3 poli (XLR3FVPRORD). Confezione standard: 4 pezzi.
- Professional XLR cable mount female socket, nickel plated die cast aluminium shell and nickel plated aluminium coupling ring, inner nylon clamping system with PVC terminal spring. Available models: 3-pole (XLR3FVPRORD) Ring colour: red. Master pack: 4 pcs.



XLR CABLE MOUNT MALE CONNECTORS

CONNECTORS

XLR3MV - XLR5MV

- Spina volante XLR con manicotto nichelato. Modelli disponibili: 3 poli (XLR3MV) e 5 poli (XLR5MV). Confezione standard: 4 pezzi.
- Professional XLR cable mount male plug, nickel plated shell. Available models: 3P (XLR3MV) - 5P (XLR5MV) Master pack: 4 pcs.



XLR3MVBK

- Spina volante XLR con manicotto nichelato nero. Confezione standard: 4 pezzi.
- Professional XLR cable mount male plug, nickel plated black shell. Master pack: 4 pcs.



XLR3MVPRO

- Spina volante XLR professionale 3P. Manicotto in alluminio pressofuso nichelato e ghiera stringicavo in alluminio nichelato, pinza interna in nylon con molla terminale in PVC. Confezione standard: 4 pezzi.
- Professional 3P XLR cable mount male plug, nickel plated die cast aluminium shell and nickel plated aluminium coupling ring, inner nylon clamping system with PVC terminal spring. Master pack: 4 pcs.



XLR5MVPRO

- Spina volante XLR professionale 5P. Manicotto in alluminio pressofuso nichelato e ghiera stringicavo in alluminio nichelato, pinza interna in nylon con molla terminale in PVC. Confezione standard: 4 pezzi.
- Professional 5P XLR cable mount male plug, nickel plated die cast aluminium shell and nickel plated aluminium coupling ring, inner nylon clamping system with PVC terminal spring. Master pack: 4 pcs.



XLR3MVPRON - XLR5MVPRON NEW

- Spina volante XLR professionale. Manicotto e ghiera stringicavo in alluminio pressofuso di colore nero, pinza interna in nylon con molla terminale in PVC. Disponibile nella versione a 3 poli (XLR3MVPRON) ed a 5 poli (XLR5MVPRON). Confezione standard: 4 pezzi.
- Professional XLR cable mount male plug socket, black colour die cast aluminium shell and coupling ring, inner nylon clamping system with PVC terminal spring. Available model: 3-pole (XLR3MVPRON) - 5-pole (XLR5MVPRON). Master pack: 4 pcs.



XLR3MVPROBK

- Spina volante XLR professionale. Manicotto in alluminio pressofuso nichelato e ghiera stringicavo in alluminio nichelato, pinza interna in nylon con molla terminale in PVC. Colore anello: nero. Disponibile nella versione a 3 poli (XLR3MVPROBK). Confezione standard: 4 pezzi.
- Professional XLR cable mount male plug, nickel plated die cast aluminium shell and nickel plated aluminium coupling ring, inner nylon clamping system with PVC terminal spring. Available models: 3-pole (XLR3MVPROBK) Ring colour: black. Master pack: 4 pcs.



XLR3MVPROBL

- Spina volante XLR professionale. Manicotto in alluminio pressofuso nichelato e ghiera stringicavo in alluminio nichelato, pinza interna in nylon con molla terminale in PVC. Colore anello: blue. Disponibile nella versione a 3 poli (XLR3MVPROBL). Confezione standard: 4 pezzi.
- Professional XLR cable mount male plug, nickel plated die cast aluminium shell and nickel plated aluminium coupling ring, inner nylon clamping system with PVC terminal spring. Available models: 3-pole (XLR3MVPROBL) Ring colour: blue. Master pack: 4 pcs.



XLR3MVPRORD

- Spina volante XLR professionale. Manicotto in alluminio pressofuso nichelato e ghiera stringicavo in alluminio nichelato, pinza interna in nylon con molla terminale in PVC. Colore anello: rosso. Disponibile nella versione a 3 poli (XLR3MVPRORD). Confezione standard: 4 pezzi.
- Professional XLR cable mount male plug, nickel plated die cast aluminium shell and nickel plated aluminium coupling ring, inner nylon clamping system with PVC terminal spring. Available models: 3-pole (XLR3MVPRORD) Ring colour: red. Master pack: 4 pcs.



RIGHT ANGLE XLR CABLE MOUNT MALE/FEMALE CONNECTORS

CONNECTORS

XLR3MRX **NEW**

- Spina volante XLR 3 poli angolare a 90° con manicotto nichelato e passacavo flessibile in PVC. Confezione standard: 4 pezzi.
- 3-pole XLR cable mount right-angled male plug with nickel plated shell and PVC flexible cable outlet. Master pack: 4 pcs.



XLR3FRX **NEW**

- Presa volante XLR 3 poli angolare a 90° con manicotto nichelato e passacavo flessibile in PVC. Confezione standard: 4 pezzi.
- 3-pole XLR cable mount right-angled female socket with nickel plated shell and PVC flexible cable outlet. Master pack: 4 pcs.



PROEL - XLR PANEL MOUNT FEMALE CONNECTORS

XLR3FDL

- Presa da pannello XLR in alluminio 3 poli con push, a saldare. Colore: nichelato. Confezione standard: 4 pezzi.
- 3-pole XLR panel mount solder aluminium female receptacle with latch. Colour: nickel. Master pack: 4 pcs.



XLR3FDLBK

- Presa da pannello XLR in alluminio 3 poli con push, a saldare. Colore: Nero. Confezione standard: 4 pezzi.
- 3-pole XLR panel mount solder aluminium female receptacle with latch. Colour: Black. Master pack: 4 pcs.



XLR3FDLX **NEW**

- Presa da pannello XLR in alluminio 3 poli con push, a saldare. Colore: nichelato. Confezione standard: 4 pezzi.
- 3-pole XLR panel mount solder aluminium female receptacle with latch. Colour: nickel. Master pack: 4 pcs.



XLR5FDL

- Presa da pannello XLR in alluminio 5 poli con push, a saldare. Colore: nichelato. Confezione standard: 4 pezzi.
- 5-pole XLR panel mount solder aluminium female receptacle with latch. Colour: nickel. Master pack: 4 pcs.



PROEL - XLR PANEL MOUNT MALE CONNECTORS

XLR3MDL

- Spina da pannello XLR in alluminio 3 poli, a saldare. Colore: nichelato. Confezione standard: 4 pezzi.
- 3-pole XLR panel mount solder aluminium male receptacle. Colour: nickel. Master pack: 4 pcs.



XLR3MDLBK

- Spina da pannello XLR in alluminio 3 poli, a saldare. Colore: nero. Confezione standard: 4 pezzi.
- 3-pole XLR panel mount solder aluminium male receptacle. Colour: Black. Master pack: 4 pcs.



XLR3MDLX **NEW**

- Spina da pannello XLR in alluminio 3 poli, a saldare. Colore: nichelato. Confezione standard: 4 pezzi.
- 3-pole XLR panel mount solder aluminium male receptacle. Colour: nickel. Master pack: 4 pcs.



XLR5MDL

- Spina da pannello XLR in alluminio 5 poli, a saldare. Colore: nichelato. Confezione standard: 4 pezzi.
- 5-pole XLR panel mount solder aluminium male receptacle. Colour: nickel. Master pack: 4 pcs.



RCA CONNECTORS

CONNECTORS

MRCA20BK - MRCA20RD

- Spina volante RCA con manicotto in ottone nichelato e molla passacavo flessibile Ø 6.2 mm. Disponibile con: anello terminale nero (MRCA20BK) - anello terminale rosso (MRCA20RD). Confezione standard: 2 pezzi.
- *RCA cable mount male plug with nickel plated brass shell and Ø 6.2 mm flexible cable spring. Available colours: black shell ring (MRCA20BK), red shell ring (MRCA20RD). Master pack: 2 pcs.*

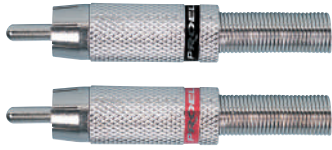

MRCA25BK - MRCA25RD

- Spina volante RCA con contatti dorati, manicotto in alluminio nero e molla passacavo flessibile Ø 6.2 mm. Disponibile con: anello terminale nero (MRCA25BK) - anello terminale rosso (MRCA25RD). Confezione standard: 2 pezzi.
- *RCA cable mount male plug with gold plated contacts, black aluminium shell and Ø 6.2 mm flexible cable spring. Available colours: black shell ring (MRCA25BK), red shell ring (MRCA25RD). Master pack: 2 pcs.*



MRCA30BK - MRCA30RD

- Spina volante RCA con contatti e manicotto dorati, molla passacavo flessibile Ø 6.2 mm. Disponibile con: anello terminale nero (MRCA30BK) - anello terminale rosso (MRCA30RD). Confezione standard: 2 pezzi.
- *RCA cable mount male plug with gold plated contacts and shell, Ø 6.2 mm flexible cable spring. Available colours: black shell ring (MRCA30BK), red shell ring (MRCA30RD). Master pack: 2 pcs.*

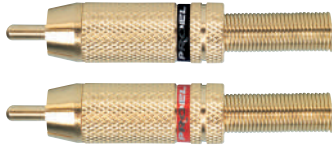

MRCA35BK - MRCA35RD

- Spina volante RCA con contatti dorati, manicotto in ottone argentato e passacavo Ø 6.2 mm. Disponibile con: anello terminale nero (MRCA35BK) - anello terminale rosso (MRCA35RD). Confezione standard: 2 pezzi.
- *RCA cable mount male plug with gold plated contacts, silver plated brass shell and Ø 6.2 mm cable outlet. Available colours: black shell ring (MRCA35BK), red shell ring (MRCA35RD). Master pack: 2 pcs.*

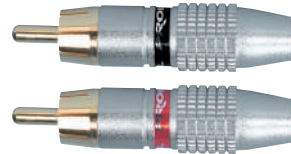

MRCA48BK - MRCA48RD

- Spina volante RCA professionale con contatti dorati, manicotto in ottone antracite lucido e molla passacavo flessibile Ø 7.2 mm. Disponibile con: anello terminale nero (MRCA48BK) - anello terminale rosso (MRCA48RD). Confezione standard: 2 pezzi.
- *Professional RCA cable mount male plug with gold plated contacts, polished anthracite brass shell and Ø 7.2 mm flexible cable spring. Available colours: black shell ring (MRCA48BK), red shell ring (MRCA48RD). Master pack: 2 pcs.*



MRCA50BK - MRCA50RD

- Spina volante RCA professionale con contatti dorati, manicotto in alluminio anodizzato nero e molla passacavo flessibile Ø 9 mm. Disponibile con: anello terminale nero (MRCA50BK) - anello terminale rosso (MRCA50RD). Confezione standard: 2 pezzi.
- *Professional RCA cable mount male plug with gold plated contacts, black anodized aluminium shell and Ø 9 mm flexible cable spring. Available colours: black shell ring (MRCA50BK), red shell ring (MRCA50RD). Master pack: 2 pcs.*



PRCA25BK - PRCA25RD

- Presa volante RCA con contatti dorati, manicotto in alluminio nero e molla passacavo flessibile Ø 6.2 mm. Disponibile con: anello terminale nero (PRCA25BK) - anello terminale rosso (PRCA25RD). Confezione standard: 2 pezzi.
- *RCA cable mount female socket with gold plated contacts, black aluminium shell and Ø 6.2 mm flexible cable spring. Available colours: black shell ring (PRCA25BK), red shell ring (PRCA25RD). Master pack: 2 pcs.*



FRCA10BK - FRCA10RD

- Presa da pannello RCA con contatti e corpo dorati. Disponibile con: anello di identificazione nero (FRCA10BK), rosso (FRCA10RD). Confezione standard: 2 pezzi.
- *RCA panel mount female socket with gold plated contacts and shell. Available colours: black mounting ring (FRCA10BK) and red mounting ring (FRCA10RD). Master pack: 2 pcs.*

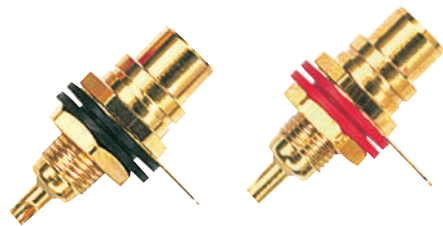

FRCA20RD - FRCA20WH

- Presa da pannello RCA con flangia quadrata. Contatti e corpo dorati, presa isolata elettricamente dall'alloggiamento, montaggio a saldare. Colore anello di isolamento: bianco (FRCA20WH), rosso (FRCA20RD). Confezione standard: 1 pezzo.
- *RCA panel mount female receptacle with square flange. Gold plated contacts and body, female receptacle electrically insulated from the housing, solder mounting. Insulating ring colour: red (FRCA20RD), white (FRCA20WH). Master pack: 1 pc.*

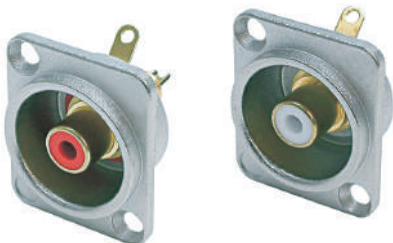

ABS ADAPTERS CONNECTORS

AT100

- Adattatore in ABS: presa jack mono Ø 6.3 mm. -> spina jack mono Ø 3.5 mm. Confezione standard: 5 pezzi.
- ABS adapter: Ø 6.3 mm mono jack female socket -> Ø 3.5 mm mono jack male plug. Master pack: 5 pcs.



AT120

- Adattatore in ABS: presa jack stereo Ø 6.3 mm. -> spina jack stereo Ø 3.5 mm. Confezione standard: 5 pezzi.
- ABS adapter: Ø 6.3 mm stereo jack female socket -> Ø 3.5 mm stereo jack male plug. Master pack: 5 pcs.



AT128

- Adattatore in ABS: n. 2 prese RCA -> spina jack stereo Ø 3.5 mm. Confezione standard: 5 pezzi.
- ABS adapter: n. 2 x RCA female sockets -> Ø 3.5 mm. stereo jack male plug. Master pack: 5 pcs.



AT140

- Adattatore in ABS: n. 2 prese jack stereo Ø 3.5 mm. -> spina jack stereo Ø 3.5 mm. Confezione standard: 5 pezzi.
- ABS adapter: n. 2 x Ø 3.5 mm stereo jack female sockets -> Ø 3.5 mm stereo jack male plug. Master pack: 5 pcs.



AT148

- Adattatore in ABS: n. 2 prese jack stereo Ø 6.3 mm. -> spina jack stereo Ø 3.5 mm. Confezione standard: 5 pezzi.
- ABS adapter: n. 2 x Ø 6.3 mm stereo jack female sockets -> Ø 3.5 mm stereo jack male plug. Master pack: 5 pcs.



AT155

- Adattatore in ABS: presa jack mono Ø 3.5 mm. -> spina jack mono Ø 6.3 mm. Confezione standard: 5 pezzi.
- ABS adapter: Ø 3.5 mm mono jack female socket -> Ø 6.3 mm mono jack male plug. Master pack: 5 pcs.



AT160

- Adattatore in ABS: n. 2 prese jack mono Ø 6.3 mm. -> spina jack mono Ø 6.3 mm. Confezione standard: 5 pezzi.
- ABS adapter: n. 2 x Ø 6.3 mm mono jack female sockets -> Ø 6.3 mm mono jack male plug. Master pack: 5 pcs.

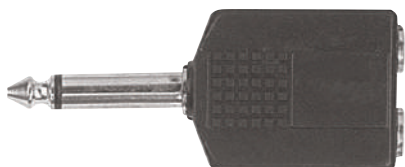

AT165

- Adattatore in ABS: presa jack stereo Ø 3.5 -> spina jack stereo Ø 6.3 mm. Confezione standard: 5 pezzi.
- ABS adapter: Ø 3.5 mm stereo jack female socket -> Ø 6.3 mm stereo jack male plug. Master pack: 5 pcs.



AT170

- Adattatore in ABS: n. 2 prese jack stereo Ø 6.3 mm. -> spina jack stereo Ø 6.3 mm. Confezione standard: 5 pezzi.
- ABS adapter: n. 2 x Ø 6.3 mm stereo jack female sockets -> Ø 6.3 mm stereo jack male plug. Master pack: 5 pcs.

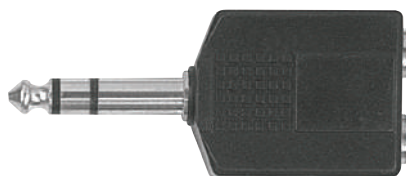

AT180

- Adattatore in ABS: presa jack mono Ø 6.3 mm. -> spina RCA. Confezione standard: 5 pezzi.
- ABS adapter: Ø 6.3 mm mono jack female socket -> RCA male plug. Master pack: 5 pcs.



ABS ADAPTERS CONNECTORS

AT190

- Adattatore in ABS: presa RCA -> spina jack mono Ø 6.3 mm. Confezione standard: 5 pezzi.
- ABS adapter: RCA female socket -> Ø 6.3 mm mono jack male plug. Master pack: 5 pcs.



AT190M

- Adattatore in metallo: presa RCA -> spina jack mono Ø 6.3 mm. Confezione standard: 5 pezzi.
- Metal adapter: RCA female socket -> Ø 6.3 mm mono jack male plug. Master pack: 5 pcs.



AT210

- Adattatore in ABS: presa RCA -> presa RCA. Confezione standard: 5 pezzi.
- ABS adapter: RCA female socket -> RCA female socket. Master pack: 5 pcs.



AT215

- Adattatore in ABS: n. 2 prese RCA (contatti dorati) -> n. 2 prese RCA (contatti dorati). Confezione standard: 5 pezzi.
- ABS adapter: n. 2 RCA female sockets (gold plated contacts) -> 2 RCA female sockets (gold plated contacts). Master pack: 5 pcs.

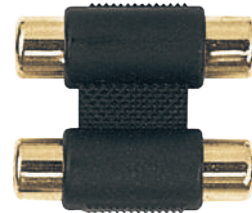

AT230

- Adattatore in ABS n. 2 prese RCA -> spina RCA. Confezione standard: 5 pezzi.
- ABS adapter: 2 RCA female sockets -> RCA male plug. Master pack: 5 pcs.



AT240

- Adattatore in ABS: n. 2 prese RCA -> spina jack mono Ø 6.3 mm. Confezione standard: 5 pezzi.
- ABS adapter: n. 2 x RCA female sockets -> Ø 6.3 mm mono jack male plug. Master pack: 5 pcs.

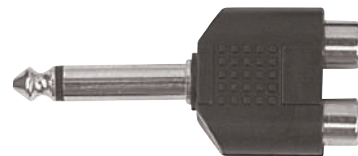

AT250

- Adattatore in ABS: n. 2 prese RCA -> spina jack stereo Ø 6.3 mm. Confezione standard: 5 pezzi.
- ABS adapter: n. 2 x RCA female sockets -> Ø 6.3 mm stereo jack male plug. Master pack: 5 pz.

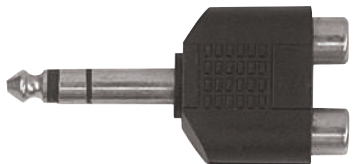

PROFESSIONAL PVC ADAPTERS CONNECTORS

AT120PRO

- Adattatore professionale realizzato in PVC ad alta resistenza a doppia stampata, con terminazioni in finitura nickel anticorrosione: spina 3,5 mm stereo > presa 6,3 mm stereo. Confezione standard: 1 pezzo.
- Professional adapter made of high-strength double molded PVC, with corrosion free nickel plated connections: 3,5 mm stereo plug > 6,3 mm stereo socket. Master pack: 1 pc.



AT128PRO

- Adattatore professionale realizzato in PVC ad alta resistenza a doppia stampata, con terminazioni in finitura nickel anticorrosione: spina 3,5 mm stereo > 2 x presa RCA. Confezione standard: 1 pezzo.
- Professional adapter made of high-strength double molded PVC, with corrosion free nickel plated connections: 3,5 mm stereo plug > 2 x RCA socket. Master pack: 1 pc.



AT140PRO

- Adattatore professionale realizzato in PVC ad alta resistenza a doppia stampata, con terminazioni in finitura nickel anticorrosione: spina 3,5 mm stereo > 2 x presa 3,5 mm stereo. Confezione standard: 1 pezzo.
- Professional adapter made of high-strength double molded PVC, with corrosion free nickel plated connections: 3,5 mm stereo plug > 2 x 3,5 mm stereo socket. Master pack: 1 pc.



AT148PRO

- Adattatore professionale realizzato in PVC ad alta resistenza a doppia stampata, con terminazioni in finitura nickel anticorrosione: spina 3,5 mm stereo > 2 x presa 6,3 mm stereo. Confezione standard: 1 pezzo.
- Professional adapter made of high-strength double molded PVC, with corrosion free nickel plated connections: 3,5 mm stereo plug > 2 x 6,3 mm stereo socket. Master pack: 1 pc.



AT165PRO

- Adattatore professionale realizzato in PVC ad alta resistenza a doppia stampata, con terminazioni in finitura nickel anticorrosione: spina 6,3 mm stereo > presa 3,5 mm stereo. Confezione standard: 1 pezzo.
- Professional adapter made of high-strength double molded PVC, with corrosion free nickel plated connections: 6,3 mm stereo plug > 3,5 mm stereo socket. Master pack: 1 pc.



AT170PRO

- Adattatore professionale realizzato in PVC ad alta resistenza a doppia stampata, con terminazioni in finitura nickel anticorrosione: spina 6,3 mm stereo > 2 x presa 6,3 mm stereo. Confezione standard: 1 pezzo.
- Professional adapter made of high-strength double molded PVC, with corrosion free nickel plated connections: 6,3 mm stereo plug > 2 x 6,3 mm stereo socket. Master pack: 1 pc.



AT175PRO

- Adattatore professionale realizzato in PVC ad alta resistenza a doppia stampata, con terminazioni in finitura nickel anticorrosione: spina 6,3 mm stereo > 2 x presa 3,5 mm stereo. Confezione standard: 1 pezzo.
- Professional adapter made of high-strength double molded PVC, with corrosion free nickel plated connections: 6,3 mm stereo plug > 2 x 3,5 mm stereo socket. Master pack: 1 pc.



AT190PRO

- Adattatore professionale realizzato in PVC ad alta resistenza a doppia stampata, con terminazioni in finitura nickel anticorrosione: spina 6,3 mm mono > presa RCA. Confezione standard: 1 pezzo.
- Professional adapter made of high-strength double molded PVC, with corrosion free nickel plated connections: 6,3 mm mono plug > RCA socket. Master pack: 1 pc.



AT230PRO

- Adattatore professionale realizzato in PVC ad alta resistenza a doppia stampata, con terminazioni in finitura nickel anticorrosione: spina RCA > 2 X presa RCA. Confezione standard: 1 pezzo.
- Professional adapter made of high-strength double molded PVC, with corrosion free nickel plated connections: RCA plug > 2 x RCA socket. Master pack: 1 pc.



AT250PRO

- Adattatore professionale realizzato in PVC ad alta resistenza a doppia stampata, con terminazioni in finitura nickel anticorrosione: spina 6,3 mm stereo > 2 X presa RCA. Confezione standard: 1 pezzo.
- Professional adapter made of high-strength double molded PVC, with corrosion free nickel plated connections: 6,3 mm stereo plug > 2 x RCA socket. Master pack: 1 pc.



AT263PRO

- Adattatore professionale ad angolo realizzato in PVC ad alta resistenza a doppia stampata, con terminazioni in finitura nickel anticorrosione: spina 6,3 mm stereo > presa 3,5 mm stereo. Confezione standard: 1 pezzo.
- Professional right angle adapter made of high-strength double molded PVC, with corrosion free nickel plated connections: 6,3 mm stereo plug > 3,5 mm stereo socket. Master pack: 1 pc.



AT280PRO

- Adattatore professionale realizzato in PVC ad alta resistenza a doppia stampata, con terminazioni in finitura nickel anticorrosione: presa 6,3 mm mono > presa 6,3 mm mono. Confezione standard: 1 pezzo.
- Professional adapter made of high-strength double molded PVC, with corrosion free nickel plated connections: 6,3 mm mono socket > 6,3 mm mono socket. Master pack: 1 pc.



PROFESSIONAL METAL ADAPTERS

CONNECTORS

AT260G

- Adattatore professionale in metallo con contatti dorati: spina jack Mono Ø 6.3 mm. -> spina jack Mono Ø 6.3 mm. Confezione standard: 4 pezzi.
- Professional metal adapter with gold plated contacts: Ø 6.3 mono jack male plug -> Ø 6.3 mm. mono jack male plug. Master pack: 4 pcs.



AT265G

- Adattatore professionale in metallo con contatti dorati: spina jack Mono Ø 6.3 mm. -> 1 spina jack Mono Ø 6.3 mm. Confezione standard: 4 pezzi.
- Professional metal adapter with gold plated contacts: Ø 6.3 mono jack male plug -> Ø 6.3 mm. mono jack male plug. Master pack: 4 pcs.



AT280

- Adattatore professionale in metallo: presa jack Mono Ø 6.3 mm. -> presa jack Mono Ø 6.3 mm. Confezione standard: 4 pezzi.
- Professional metal adapter: Ø 6.3 mono jack female socket -> Ø 6.3 mm. mono jack female socket. Master pack: 4 pcs.



AT290

- Adattatore professionale in metallo: presa XLR 3 poli -> spina jack Mono Ø 6.3 mm. Confezione standard: 4 pezzi.
- Professional metal adapter: 3-pole XLR female socket -> Ø 6.3 mm. mono jack male plug. Master pack: 4 pcs.



AT295

- Adattatore professionale in metallo: presa XLR 3 poli -> spina jack Stereo Ø 6.3 mm. Confezione standard: 4 pezzi.
- Professional metal adapter: 3-pole XLR female socket -> Ø 6.3 mm. stereo jack male plug. Master pack: 4 pcs.



AT300

- Adattatore professionale in metallo: spina XLR 3 poli -> spina jack Mono Ø 6.3 mm. Confezione standard: 4 pezzi.
- Professional metal adapter: 3-pole XLR female socket -> Ø 6.3 mm. stereo jack male plug. Master pack: 4 pcs.



AT305

- Adattatore professionale in metallo: spina XLR 3 poli -> spina jack Stereo Ø 6.3 mm. Confezione standard: 4 pezzi.
- Professional metal adapter: 3-pole XLR male plug -> Ø 6.3 mm. stereo jack male plug. Master pack: 4 pcs.



AT310

- Adattatore professionale in metallo: presa XLR 3 poli -> presa jack Mono Ø 6.3 mm. Confezione standard: 4 pezzi.
- Professional metal adapter: 3-pole XLR female socket -> Ø 6.3 mm. mono jack female socket. Master pack: 4 pcs.



AT320

- Adattatore professionale in metallo: spina XLR 3 poli -> presa jack Mono Ø 6.3 mm. Confezione standard: 4 pezzi.
- Professional metal adapter: 3-pole XLR male plug -> Ø 6.3 mm. mono jack female socket. Master pack: 4 pcs.



AT330

- Adattatore professionale in metallo: spina XLR 3 poli -> spina XLR 3 poli. Confezione standard: 4 pezzi.
- Professional metal adapter: 3-pole XLR male plug -> 3-pole XLR male plug. Master pack: 4 pcs.



PROFESSIONAL METAL ADAPTERS CONNECTORS

AT340

- Adattatore professionale in metallo : presa XLR 3 poli -> presa XLR 3 poli. Confezione standard: 4 pezzi.
- Professional metal adapter: 3-pole XLR female socket -> 3-pole XLR female socket. Master pack: 4 pcs.



AT500

- Adattatore professionale in metallo : spina XLR 3 poli -> presa RCA. Confezione standard: 4 pezzi.
- Professional metal adapter : 3-pole XLR male plug -> RCA female socket. Master pack: 4 pcs.



AT510

- Adattatore professionale in metallo: presa XLR 3 poli -> spina RCA. Confezione standard: 4 pezzi.
- Professional metal adapter: 3-pole XLR female socket -> RCA male plug. Master pack: 4 pcs.



AT520

- Adattatore professionale in metallo : presa XLR 3 poli -> presa RCA. Confezione standard: 4 pezzi.
- Professional metal adapter: 3-pole XLR female socket -> RCA female socket. Master pack: 4 pcs.



AT530

- Adattatore professionale in metallo: spina XLR 3 poli -> spina RCA. Confezione standard: 4 pezzi.
- Professional metal adapter: 3-pole XLR male plug -> RCA male plug. Master pack: 4 pcs.



AT615

- Adattatore professionale in metallo: presa con sicura jack Stereo Ø 6.3 mm. -> spina XLR 3 poli. Confezione standard: 4 pezzi.
- Professional metal adapter: Ø 6.3 mm. stereo jack female socket with security lock -> 3-pole XLR male plug. Master pack: 4 pcs.

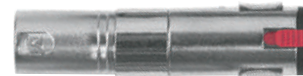

AT625

- Adattatore professionale in metallo: presa con sicura jack Stereo Ø 6.3 mm. -> presa XLR 3 poli. Confezione standard: 4 pezzi.
- Professional metal adapter: Ø 6.3 mm. stereo jack female socket with security lock -> 3-pole XLR female socket. Master pack: 4 pcs.



AT635

- Adattatore professionale in metallo: presa con sicura jack Stereo Ø 6.3 mm. -> presa con sicura jack Stereo Ø 6.3 mm. Confezione standard: 4 pezzi.
- Professional metal adapter: Ø 6.3 mm. stereo jack female socket with security lock -> Ø 6.3 mm. stereo jack female socket with security lock. Master pack: 4 pcs.



PROFESSIONAL DMX ADAPTERS

AT350DMX

- Adattatore professionale in metallo per cavi DMX - presa XLR 3 poli -> spina XLR 5 poli. Confezione standard: 4 pezzi.
- Professional metal adapter for DMX cables: 3-pole XLR female socket -> 5-pole XLR male socket. Master pack: 4 pcs.



AT355DMX

- Adattatore professionale in metallo per cavi DMX - presa XLR 5 poli -> spina XLR 3 poli. Confezione standard: 4 pezzi.
- Professional metal adapter for DMX cables: 5-pole XLR female socket -> 3-pole XLR male socket. Master pack: 4 pcs.



AUDIO SYSTEMS

• Proel produce prodotti audio da lungo tempo ed il nostro successo scaturisce da una dedizione costante nella ricerca e nel seguire le nuove esigenze del mercato. Nel nuovo settore Audio Systems troverete prodotti per quasi tutte le tipologie di applicazioni dal prodotto più semplice a soluzioni completamente espandibili. Tutti i prodotti del settore Audio Systems sono realizzati utilizzando solo componenti di altissima qualità, le più moderne tecniche costruttive e procedure di prova avanzate. Utilizzando il nostro centro di ricerca ed i reparti di produzione interna la Proel è in grado di offrire, inoltre, sistemi audio e soluzioni su misura seguendo le specifiche per le esigenze del cliente. Tutti i prodotti sono completamente garantiti e tutti i componenti sono testati pre e post-montaggio per garantire un'affidabilità a lungo termine.

• Proel has been manufacturing audio products for a longtime and our success spring from a constant dedication in research and following the market requirements. In the new edition of Proel Audio systems you will find products for almost every kind of application from the simplest product to fully expandable solutions. All Audio system products are manufactured using only the highest quality components, latest manufacturing techniques and advanced test procedures. Using our state of the art in house design and manufacturing facilities Proel can offer bespoke audio systems and solutions to customer specifications and requirements. All product is fully warranted and all components tested pre and post assembly to ensure long term reliability.

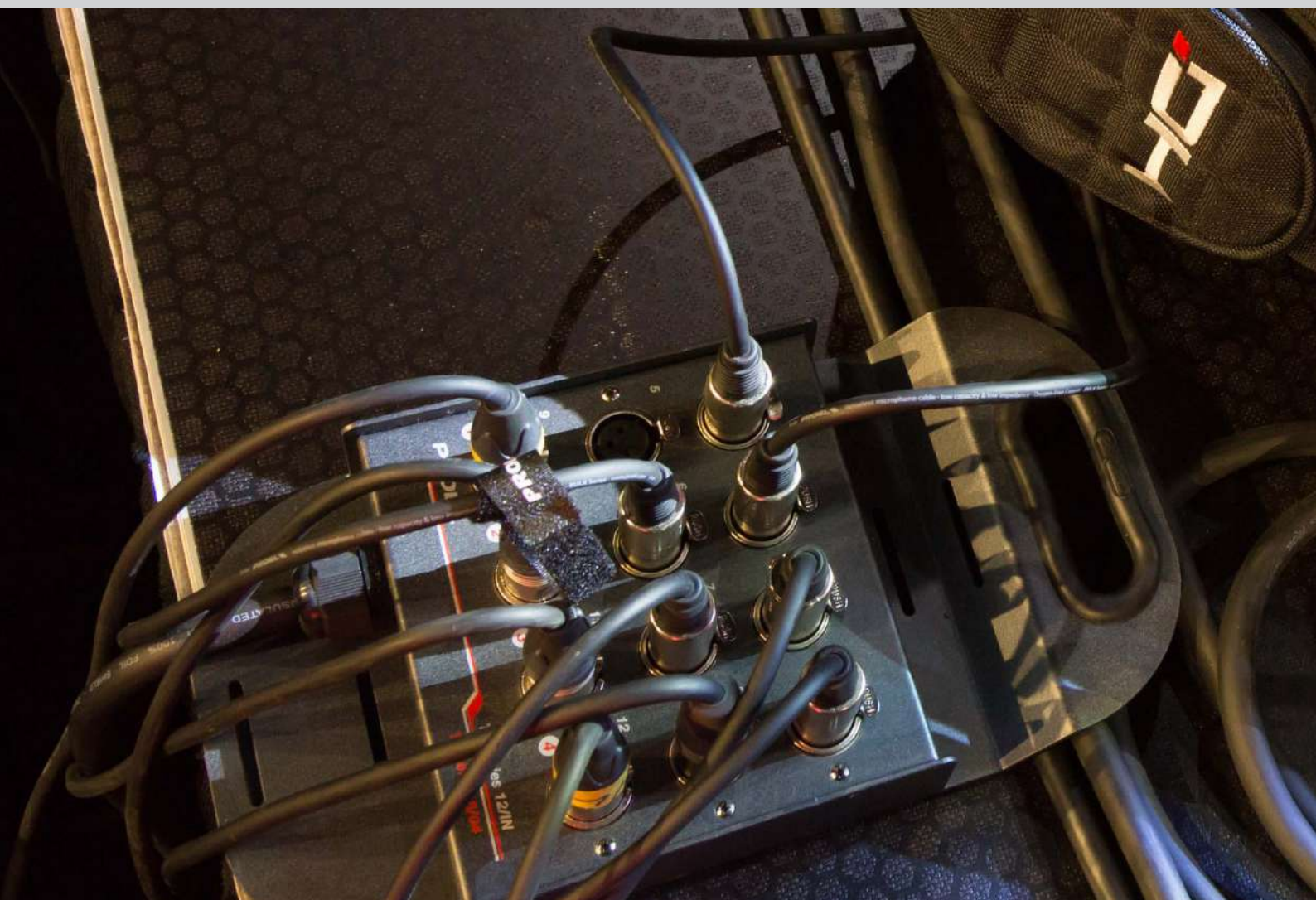

Made in Italy



Proel Connector



Neutrik Connector



AUDIO STAGE BOXES "EZ" SERIES

AUDIO SYSTEMS



EZBOX1604



Neutrik XLR panel mount connectors

EZBOX1204 - EZBOX1604

• Comoda, pratica, compatta. Queste le peculiari caratteristiche della nuova EZBOX PROEL. Questa stage box si distingue per il design originale che consente al cavo di essere avvolto intorno alla struttura durante il trasporto ed essere utilizzato comodamente sia in posizione verticale che orizzontale. EZBOX, disponibile in due differenti configurazioni (EZBOX1204/EZBOX1604), utilizza connettori appositamente studiati da PROEL, adattabili alle più svariate esigenze dei diversi utilizzatori (es. musicisti, società di noleggio, ecc.) E' progettata per usi polivalenti quali: connessione di kit di microfoni per batteria, postazioni molto estese di tastiere, sistema principale multi-canale. EZBOX unisce praticità, convenienza e portabilità in una struttura molto facile da usare.

• Comfortable, practical, compact. These are the words that can be used to describe the new PROEL EZ BOX. This stage box features an original design allowing the cable to be wrapped around the structure for transport and allows the box to be used comfortably both upright or laying down. The EZBOX features high quality panel mount NEUTRIK connectors and heavy-duty cable mount PROEL connectors. It is available in two different formats (EZBOX1204/EZBOX1604) making it the ideal choice for the touring musician and the rental company who need high quality connections on stage without carrying around bulky flight-cases. Designed for use on stage for the connection of drum kit microphones, for large keyboard rigs, or - in the case of the smaller band, as the main multicore system. EZBOX combines practicality, convenience and portability into a box that can only be described as easy to use.



| Code | PANEL | | Terminal | TERMINAL | | | |
|-----------|--------|---------|----------|-------------------|--------|--|--|
| | Inputs | Outputs | | Cable Pairs | Length | | |
| EZBOX1204 | 12 XLR | 4 XLR | 16 | 15 mt - 49,21 ft. | | | |
| EZBOX1604 | 16 XLR | 4 XLR | 20 | 15 mt - 49,21 ft. | | | |

AUDIO STAGE BOXES "EBN" SERIES

AUDIO SYSTEMS

EBN1604



EBN

• La serie EBN, costruita con scatola in metallo verniciato a polveri epossidiche, presenta peso e dimensioni ridotte grazie al circuito stampato professionale sul quale sono posizionati i connettori XLR da pannello in nylon di alta qualità e cablati in automatico. Connessioni volanti protette con guaine in PVC e cablate con connettori XLRPRO con corpo interamente in metallo. Cavo multipolare CMF con masse a contatto. Configurazioni fino a 40 canali.

• The EBN series, built in Epoxy powder finished metal box, features small weight and dimension thanks to its professional printed circuit. High quality XLR gold-plated contacts nylon NEUTRIK connectors, wired in automatic. Cable mount connections protected by PVC jackets and wired with XLRPRO metal connectors. CMF multicore cable featuring contact earth. Configurations up to 40 channels.

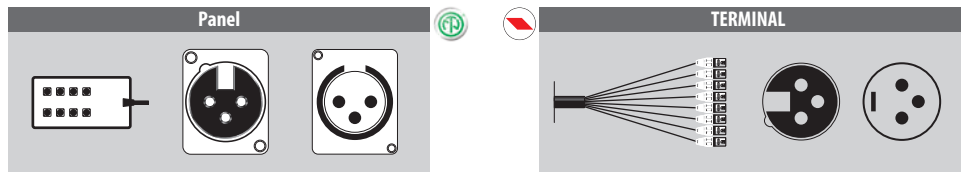

EBN8



EBN1204



EBN2408



EBN3208



| Code | Panel | Terminal | Inputs | Outputs | Cable Pairs | Length |
|------------------------|-------|----------|----------------|----------------|-------------|-----------------------------------|
| EBN8LU10 EBN8 | | | 8 XLR 8 XLR | / / | 8 8 | 10 mt - 33 ft. 15 mt - 50 ft. |
| EBN804LU10 EBN804 | | | 8 XLR 8 XLR | 4 XLR 4 XLR | 12 12 | 10 mt - 33 ft. 25 mt - 82 ft. |
| EBN1204 | | | 12 XLR | 4 XLR | 16 | 25 mt - 82 ft. |
| EBN1604 | | | 16 XLR | 4 XLR | 20 | 25 mt - 82 ft. |
| EBN2408 EBN2408LU50 | | | 24 XLR | 8 XLR | 32 | 25 mt - 82 ft. 50 mt - 165 ft. |
| EBN3208 EBN3208LU50 | | | 32 XLR | 8 XLR | 40 | 30 mt - 99 ft. 50 mt - 165 ft. |

AUDIO STAGE BOXES "TN" SERIES

AUDIO SYSTEMS



TN8IN



TN0804



TN12IN



TN1204



TN



• Scatola box in lamiera zincata poi verniciata a polveri epossidiche ad altissima resistenza. Costruita con parametri riferiti alle norme di sicurezza attualmente vigenti, e lavorata con le più sofisticate attrezzature. Connessioni XLR in metallo, cavo multipolare a masse separate serie "CMN" ed assemblaggio di alta qualità. Saldature a stagno 80/20. Copertura delle terminazioni volanti con guaine ad alta resistenza per temperature fino a 150°C. Configurazioni fino a 40 canali.

• Galvanized metal sheet stage box with highly resistant epoxy paint. Built in accordance with the security regulations in force at present, and manufactured with the most sophisticated equipment. XLR metal connections, "CMN" series multicore cable with separate earth and high quality assembly. 80/20 tin welding. Cable mount terminal covers highly resistant to temperatures up to 150°C. Configurations up to 40 channels.

| Code | PANEL | | Terminal | TERMINAL | | | |
|------------|-------|----------|----------|----------|---------|-------------|-----------------|
| | Panel | Terminal | | Inputs | Outputs | Cable Pairs | Length |
| TN8IN | | | | 8 XLR | / | 8 | 10 mt - 33 ft. |
| TN8INLU20 | | | | 8 XLR | / | 8 | 20 mt - 66 ft. |
| TN0804 | | | | 8 XLR | 4 XLR | 12 | 20 mt - 66 ft. |
| TN12IN | | | | | 12 XLR | / | 12 |
| TN1204 | | | | | 12 XLR | 12 XLR | 16 |
| TN1204LU30 | | | | 12 XLR | 12 XLR | 16 | 30 mt - 99 ft. |
| TN1204LU50 | | | | 12 XLR | 12 XLR | 16 | 50 mt - 165 ft. |

AUDIO STAGE BOXES "TN" SERIES

AUDIO SYSTEMS



TN1604

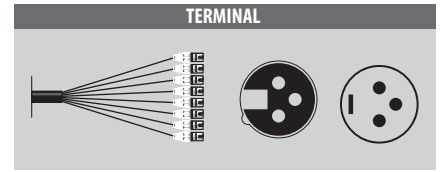
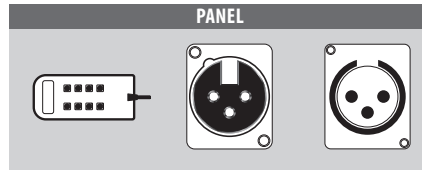

TN1608

| Code | Panel | Terminal | Inputs | Outputs | Cable Pairs | Length |
|------------|-------|----------|--------|---------|-------------|-----------------|
| TN1604 | | | 16 XLR | 4 XLR | 20 | 20 mt - 66 ft. |
| TN1604LU30 | | | 16 XLR | 4 XLR | 20 | 30 mt - 99 ft. |
| TN1604LU50 | | | 16 XLR | 4 XLR | 20 | 50 mt - 165 ft. |

| | | | | | | |
|------------|--|--|--------|-------|----|-----------------|
| TN1608 | | | 16 XLR | 8 XLR | 24 | 30 mt - 99 ft. |
| TN1608LU50 | | | 16 XLR | 8 XLR | 24 | 50 mt - 165 ft. |



TN2408

| | | | | | | |
|------------|--|--|--------|-------|----|-----------------|
| TN2408 | | | 24 XLR | 8 XLR | 32 | 20 mt - 66 ft. |
| TN2408LU30 | | | 24 XLR | 8 XLR | 32 | 30 mt - 99 ft. |
| TN2408LU40 | | | 24 XLR | 8 XLR | 32 | 40 mt - 122 ft. |
| TN2408LU50 | | | 24 XLR | 8 XLR | 32 | 50 mt - 165 ft. |



TN3208

| | | | | | | |
|------------|--|--|--------|-------|----|-----------------|
| TN3208 | | | 32 XLR | 8 XLR | 40 | 30 mt - 99 ft. |
| TN3208LU50 | | | 32 XLR | 8 XLR | 40 | 50 mt - 165 ft. |

PROFESSIONAL AUDIO STAGE BOXES "NK" SERIES

AUDIO SYSTEMS



NK

BOX2408S



• La serie di sistemi audio PROEL "NK" offre stage boxes altamente flessibili, costruite in scatole a passo rack 19" in metallo verniciato a polveri epossidiche di colore nero automontanti, che permettono qualsiasi tipo di configurazione. La serie NK è corredata di connettori multipolari CMIL, che consentono di scollegare il cavo dalla stage box facilitando l'installazione anche con cavi di consistente lunghezza. Il cavo multipolare utilizzato è a masse separate (CMN). Le connessioni CMIL e XLR sono in metallo di alta qualità. Le protezioni delle derivazioni sono realizzate con guaine ad alta resistenza meccanica. Combinazioni fino a 48 canali, configurazioni custom. Tutti i cavi sono dotati di connettori di alta qualità, connettori multipolari con attacco a baionetta e cavo a masse separate CMN.

• PROEL "NK" series of audio systems offers highly flexible stage boxes, built in 19" rack automatic stage boxes, black epoxy finish metal, allowing any kind of configuration. The NK series is fitted with CMIL multipin connectors allowing cable disconnection from stage box for an easy installation even with very long cables. Multicore cable with separate earth (CMN). CMIL and XLR connections are made of high quality metal. Shunt protection are realized with high-mechanical resistance jackets. Combinations up to 48 channels, custom configurations. All cables are fitted with high quality connectors, multipin bayonet-mount connectors and CMN earth separate cable.

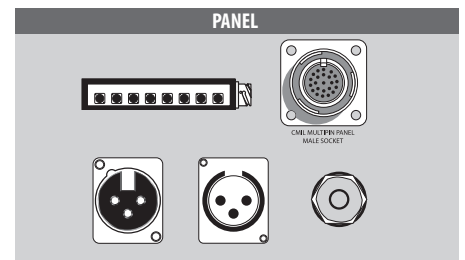
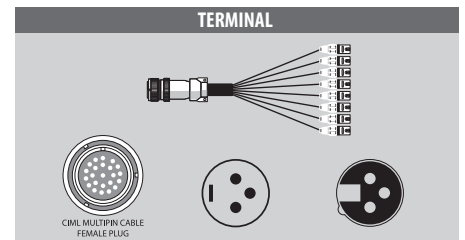
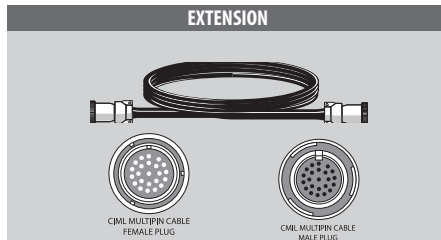
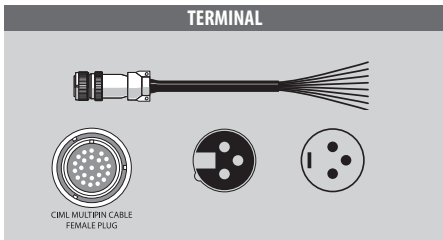
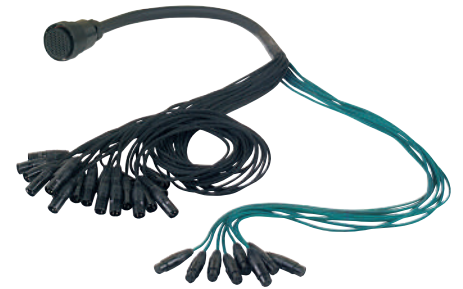

PROFESSIONAL AUDIO STAGE BOXES "NK" SERIES

AUDIO SYSTEMS

BOX8S

- Stage Box con n. 8 prese da pannello XLR 3 poli n. 1 spina da pannello multipolare CMIL25MP.
- *CMIL25MP multicore panel mount male plug.*

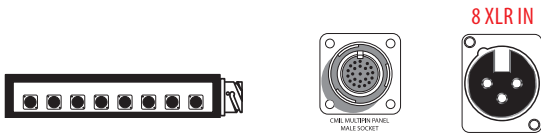

CSG2510 - CSG2520

- Cavo assemblato con cavo audio multipolare PROEL CMN8 n. 1 presa volante multipolare CMIL25FV e n. 8 spine volanti XLR 3 poli. CSG2510: 10 mt. - 33 ft. • CSG2520: 20 mt. - 66 ft.
- *Assembled cable with PROEL CMN8 multicore audio cable, n. 1 x CMIL25FV multipin cable mount female socket and 8 XLR 3-pole cable mount male plugs. CSG2510: 10 mt - 33 ft. • CSG2520: 20 mt - 66 ft.*



BOX804S

- Stage Box con n. 8 prese da pannello XLR 3 poli, n. 4 spine da pannello XLR 3 poli e n. 1 spina da pannello multipolare CMIL37MP.
- *Stage box with 8 XLR 3-pole panel mount female sockets, 4 XLR 3-pole panel mount male plugs and n. 1 x CMIL37MP multipin panel mount male plug.*

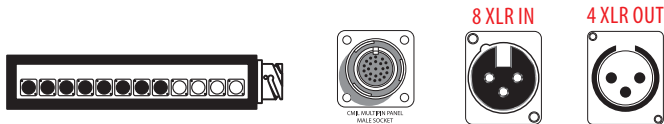

CSG3710 - CSG3720

- Cavo assemblato con cavo audio multipolare PROEL CMN12, n. 1 presa volante multipolare CMIL37FV, n. 8 spine volanti XLR 3 poli e n. 4 prese volanti XLR 3 poli. CSG3710: 10 mt. - 33 ft. • CSG3720: 20 mt. - 66 ft.
- *Assembled cable with PROEL CMN12 multipair audio cable, n. 1 x CMIL37FV multipin cable mount female socket, 8 XLR 3-pole cable mount male plugs and 4 XLR 3-pole cable mount female socket. CSG3710: 10 mt - 33 ft. • CSG3720: 20 mt - 66 ft.*



BOX1204S

- Stage Box con n. 12 prese da pannello XLR 3 poli, n. 4 spine da pannello XLR 3 poli e n. 1 spina da pannello multipolare CMIL54MP.
- *Stage box with 12 XLR 3-pole panel mount female sockets, 4 XLR 3-pole panel mount male plugs and n. 1 x CMIL54MP multipin panel mount male plug.*

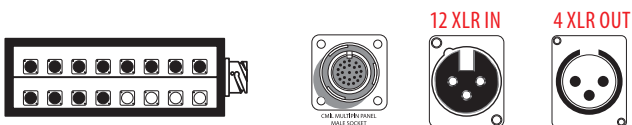

CSG5420 - CSG5430

- Cavo assemblato con cavo audio multipolare PROEL CMN16, n. 1 presa volante multipolare CMIL54FV, n. 12 spine volanti XLR 3 poli e n. 4 prese volanti XLR 3 poli. CSG5420: 20 mt. - 66 ft. • CSG5430: 30 mt - 91 ft.
- *Assembled cable with PROEL CMN16 multipair audio cable, n. 1 x CMIL54FV multipin cable mount female socket, 12 XLR 3-pole cable mount male plugs and 4 XLR 3-pole cable mount female sockets. CSG5420: 20 mt - 66 ft. • CSG5430: 30 mt - 91 ft.*



FBX8

- Cavo assemblato con cavo audio multipolare PROEL CMN8 terminante con n. 1 presa volante multipolare CMIL25FV e n. 8 spine volanti XLR 3 poli. FBX8: 1.5 mt - 4.92 ft.
- *Assembled cable with PROEL CMN8 multipair audio cable ending with n. 1 x CMIL25FV multipin cable mount female socket and 8 XLR 3-pole cable mount male plug. FBX8: 1.5 mt - 4.92 ft.*

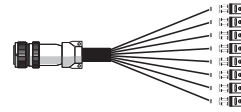

PBX2510 - PBX2520

- Cavo assemblato con cavo audio multipolare PROEL CMN8 terminante con n. 1 presa volante multipolare CMIL25FV e n. 1 spina volante multipolare CMIL25MV. PBX2510: 10 mt. - 33 ft. • PBX2520: 20 mt. - 66 ft.
- *Assembled cable with PROEL CMN8 multipair audio cable ending with n. 1 x CMIL25FV multipin cable mount female socket and n. 1 x CMIL25MV multipin cable mount male plug. PBX2510: 10 mt - 33 ft. • PBX2520: 20 mt - 66 ft.*



FBX804

- Cavo assemblato con cavo audio multipolare PROEL CMN12 terminante con n. 1 presa volante multipolare CMIL37FV, n. 8 spine volanti XLR 3 poli e n. 4 prese volanti XLR 3 poli. FBX804: 1.5 mt - 4.92 ft.
- *Assembled cable with PROEL CMN12 multipair audio cable ending with n. 1 x CMIL37FV multipin cable mount female socket, 8 XLR 3-pole cable mount male plugs and 4 XLR 3-pole cable mount female sockets. FBX804: 1.5 mt - 4.92 ft.*

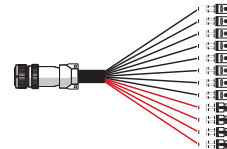

PBX3710 - PBX3720

- Cavo assemblato con cavo audio multipolare PROEL CMN12 terminante con n. 1 presa volante multipolare CMIL37FV e n. 1 spina volante multipolare CMIL37MV. PBX3710: 10 mt. - 33 ft. • PBX3720: 20 mt. - 66 ft.
- *Assembled cable with PROEL CMN12 multipair audio cable ending with n. 1 x CMIL37FV multipin cable mount female socket and n. 1 x CMIL37MV multipin cable mount male plug. PBX3710: 10 mt - 33 ft. • PBX3720: 20 mt - 66 ft.*



FBX1204

- Cavo assemblato con cavo audio multipolare PROEL CMN16 terminante con n. 1 presa volante multipolare CMIL54FV, n. 12 spine volanti XLR 3 poli e n. 4 prese volanti XLR 3 poli. FBX1204: 1.5 mt - 4.92 ft.
- *Assembled cable with PROEL CMN16 multipair audio cable ending with n. 1 x CMIL54FV multipin cable mount female socket, 12 XLR 3-pole cable mount male plugs and 4 XLR 3-pole cable mount female sockets. FBX1204: 1.5 mt - 4.92 ft.*

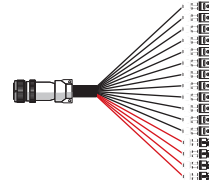

PBX5420 - PBX5430

- Cavo assemblato con cavo audio multipolare PROEL CMN16 terminante con n. 1 presa volante multipolare CMIL54FV e n. 1 spina volante multipolare CMIL54MV. PBX5420: 20 mt. - 66 ft. • PBX5430: 30 mt - 91 ft.
- *Assembled cable with PROEL CMN16 multipair audio cable ending with n. 1 x CMIL54FV multipin cable mount female socket and n. 1 x CMIL54MV multipin cable mount male plug. PBX5420: 20 mt - 66 ft. • PBX5430: 30mt - 91 ft.*



PROFESSIONAL AUDIO STAGE BOXES "NK" SERIES

AUDIO SYSTEMS

BOX1608S

- Stage Box con n. 16 prese da pannello XLR 3 poli, n. 8 spine da pannello XLR 3 poli e n. 1 spina da pannello multipolare CMIL85MP.
- Stage box with 16 XLR 3-pole panel mount female sockets, 8 XLR 3-pole panel mount male plugs and n. 1 x CMIL85MP multipin panel mount male plug.

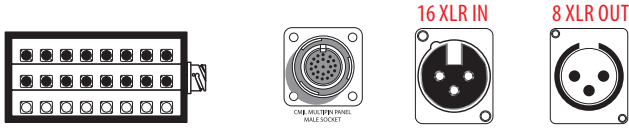

FBX1608

- Cavo assemblato con cavo audio multipolare PROEL CMN24 terminante con n. 1 presa volante multipolare CMIL85FV, n. 16 spine volanti XLR 3 poli e n. 8 prese volanti XLR 3 poli. FBX1608: 2 mt - 6.6 ft.
- Assembled cable with PROEL CMN24 multipair audio cable ending with n. 1 x CMIL85FV multipin cable mount female socket, 16 XLR 3-pole cable mount male plugs and 8 XLR 3-pole cable mount female sockets. FBX1608: 2 mt - 6.6 ft.



CBX8520 - CBX8530

- Cavo assemblato con cavo audio multipolare PROEL CMN24, n. 1 presa volante multipolare CMIL85FV, n. 16 spine volanti XLR 3 poli e n. 8 prese volanti XLR 3 poli. CBX8520: 20 mt - 66 ft. • CBX8530: 30 mt - 91 ft.
- Assembled cable with PROEL CMN24 multipair audio cable, n. 1 x CMIL85FV multipin cable mount female socket, 16 XLR 3-pole cable mount male plugs and 8 XLR 3-pole cable mount female sockets. CBX8520: 20 mt - 66 ft. • CBX8530: 30 mt - 91 ft.



PBX8520 - PBX8530

- Cavo assemblato con cavo audio multipolare PROEL CMN24 terminante con n. 1 presa volante multipolare CMIL85FV e n. 1 spina volante multipolare CMIL85MV. PBX8520: 20 mt - 66 ft. • PBX8530: 30 mt - 91 ft.
- Assembled cable with PROEL CMN24 multipair audio cable ending with n. 1 x CMIL85FV multipin cable mount female socket and n. 1 x CMIL85MV multipin cable mount male plug. PBX8520: 20 mt - 66 ft. • PBX8530: 30 mt - 91 ft.



BOXJ1608S

- Stage Box con N. 16 prese da pannello XLR 3 poli, N. 8 spine da pannello XLR 3 poli, N. 24 prese da pannello jack Ø 6.3 mm. stereo, N. 1 spina da pannello multipolare CMIL85MP.
- Stage box with 16 XLR 3-pole panel mount female sockets, 8 XLR 3-pole panel mount male plugs, 24 stereo jack Ø 6.3 mm. panel mount female sockets, n. 1 x CMIL85MP multipin panel mount male plugs.

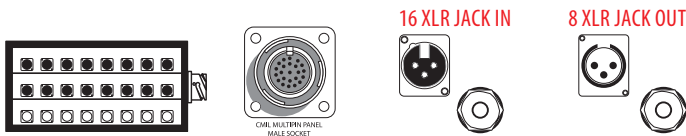

FBX1608

- Cavo assemblato con cavo audio multipolare PROEL CMN24 terminante con n. 1 presa volante multipolare CMIL85FV, n. 16 spine volanti XLR 3 poli e n. 8 prese volanti XLR 3 poli. FBX1608: 2 mt - 6.6 ft.
- Assembled cable with PROEL CMN24 multipair audio cable ending with n. 1 x CMIL85FV multipin cable mount female socket, 16 XLR 3-pole cable mount male plugs and 8 XLR 3-pole cable mount female sockets. FBX1608: 2 mt - 6.6 ft.

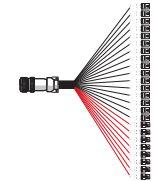

CBX8520 - CBX8530

- Cavo assemblato con cavo audio multipolare PROEL CMN24, n. 1 presa volante multipolare CMIL85FV, n. 16 spine volanti XLR 3 poli e n. 8 prese volanti XLR 3 poli. CBX8520: 20 mt - 66 ft. • CBX8530: 30 mt - 91 ft.
- Assembled cable with PROEL CMN24 multipair audio cable, n. 1 x CMIL85FV multipin cable mount female socket, 16 XLR 3-pole cable mount male plugs and 8 XLR 3-pole cable mount female sockets. CBX8520: 20 mt - 66 ft. • CBX8530: 30 mt - 91 ft.



PBX8520 - PBX8530

- Cavo assemblato con cavo audio multipolare PROEL CMN24 terminante con n. 1 presa volante multipolare CMIL85FV e n. 1 spina volante multipolare CMIL85MV. PBX8520: 20 mt - 66 ft. • PBX8530: 30 mt - 91 ft.
- Assembled cable with PROEL CMN24 multipair audio cable ending with n. 1 x CMIL85FV multipin cable mount female socket and n. 1 x CMIL85MV multipin cable mount male plug. PBX8520: 20 mt - 66 ft. • PBX8530: 30 mt - 91 ft.



BOX2408S

- Stage Box con N. 24 prese da pannello XLR 3 poli, N. 8 spine da pannello XLR 3 poli, N. 1 spina da pannello multipolare CMIL150MP.
- Stage box with 24 XLR 3-pole panel mount female sockets, 8 XLR 3-pole panel mount male plugs, n. 1 x CMIL150MP multipin panel mount male plug.



FBX2408

- Cavo assemblato con cavo audio multipolare PROEL CMN32 terminante con n. 1 presa volante multipolare CMIL150FV, n. 24 spine volanti XLR 3 poli e n. 8 prese volanti XLR 3 poli. FBX2408: 2 mt - 6.6 ft.
- Assembled cable with PROEL CMN32 multipair audio cable ending with n. 1 x CMIL150FV multipin cable mount female socket, 24 XLR 3-pole cable mount male plugs and 8 XLR 3-pole cable mount female sockets. FBX2408: 2 mt - 6.6 ft.

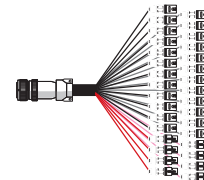

CBX15030 - CBX15050

- Cavo assemblato con cavo audio multipolare PROEL CMN32, n. 1 presa volante multipolare CMIL150FV, n. 24 spine volanti XLR 3 poli e n. 8 prese volanti XLR 3 poli. CBX15030: 30 mt - 91 ft. • CBX15050: 50 mt - 165 ft.
- Assembled cable with PROEL CMN32 multipair audio cable, n. 1 x CMIL150FV multipin cable mount female socket, 24 XLR 3-pole cable mount male plugs and 8 XLR 3-pole cable mount female sockets. CBX15030: 30 mt - 91 ft. • CBX15050: 50 mt - 165 ft.



PBX15030 - PBX15050

- Cavo assemblato con cavo audio multipolare PROEL CMN32 terminante con n. 1 presa volante multipolare CMIL150FV e n. 1 spina volante multipolare CMIL150MV. PBX15030: 30 mt - 91 ft. • PBX15050: 50 mt - 165 ft.
- Assembled cable with PROEL CMN32 multipair cable ending with CMIL150FV multipin cable mount female socket and n. 1 x CMIL150MV multipin cable mount male plug. PBX15030: 30 mt - 91 ft. • PBX15050: 50 mt - 165 ft.



PROFESSIONAL AUDIO STAGE BOXES "NK" SERIES

AUDIO SYSTEMS

BOXJ2408S

- Stage Box con N. 24 prese da pannello XLR 3 poli, N. 8 spine da pannello XLR 3 poli, N. 32 prese da pannello jack Ø 6.3 mm. stereo, N. 1 spina da pannello multipolare CMIL150MP.
- Stage box with 24 XLR 3-pole panel mount female sockets, 8 XLR 3-pole panel mount male plugs, 32 stereo jack Ø 6.3 mm panel mount female sockets, n. 1 x CMIL150MP multipin panel mount male plug.

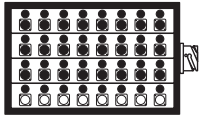

24 XLR JACK IN

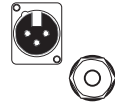

8 XLR JACK OUT

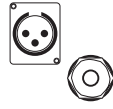

FBX2408

- Cavo assemblato con cavo audio multipolare PROEL CMN32 terminante con n. 1 presa volante multipolare CMIL150FV, n. 24 spine volanti XLR 3 poli e n. 8 prese volanti XLR 3 poli. FBX2408: 2 mt - 6.6 ft.
- Assembled cable with PROEL CMN32 multipair audio cable ending with n. 1 x CMIL150FV multipin cable mount female socket, 24 XLR 3-pole cable mount male plugs and 8 XLR 3-pole cable mount female sockets. FBX2408: 2 mt - 6.6 ft.

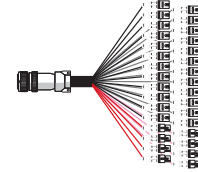

CBX15030 - CBX15050

- Cavo assemblato con cavo audio multipolare PROEL CMN32, n. 1 presa volante multipolare CMIL150FV, n. 24 spine volanti XLR 3 poli e n. 8 prese volanti XLR 3 poli. CBX15030: 30 mt - 91 ft. • CBX15050: 50 mt - 165 ft.
- Assembled cable with PROEL CMN32 multipair audio cable, n. 1 x CMIL150FV multipin cable mount female socket, 24 XLR 3-pole cable mount male plugs and 8 XLR 3-pole cable mount female sockets. CBX15030: 30 mt - 91 ft. • CBX15050: 50 mt - 165 ft.



PBX15030 - PBX15050

- Cavo assemblato con cavo audio multipolare PROEL CMN32 terminante con n. 1 presa volante multipolare CMIL150MV, n. 1 spina volante multipolare CMIL150MV. PBX15030: 30 mt - 91 ft. • PBX15050: 50 mt - 165 ft.
- Assembled cable with PROEL CMN32 multipair audio cable ending with n. 1 x CMIL150FV multipin cable mount female socket and n. 1 x CMIL150MV multipin cable mount male plug. PBX15030: 30 mt - 91 ft. • PBX15050: 50 mt - 165 ft.



BOX3208S

- Stage Box con N. 32 prese da pannello XLR 3 poli, N. 8 spine da pannello XLR 3 poli, N. 1 spina da pannello multipolare CMIL150MP.
- Stage box with 32 XLR 3-pole panel mount female sockets, 8 XLR 3-pole panel mount male plugs, n. 1 x CMIL150MP multipin panel mount male plug.

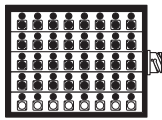

32 XLR IN

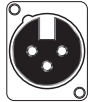

8 XLR OUT



FBX3208

- Cavo assemblato con cavo audio multipolare PROEL CMN40 terminante con n. 1 presa volante multipolare CMIL150FV, n. 32 spine volanti XLR 3 poli e n. 8 prese volanti XLR 3 poli. FBX3208: 2 mt - 6.6 ft.
- Assembled cable with PROEL CMN40 multipair audio cable ending with n. 1 x CMIL150FV multipin cable mount female socket, 32 XLR 3-pole cable mount male plugs and 8 XLR 3-pole cable mount female sockets. FBX3208: 2 mt - 6.6 ft.

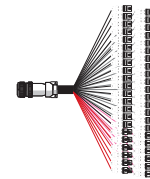

CBX15030X - CBX15050X

- Cavo assemblato con cavo audio multipolare PROEL CMN40, n. 1 presa volante multipolare CMIL150FV, n. 32 spine volanti XLR 3 poli e n. 8 prese volanti XLR 3 poli. CBX15030X: 30 mt - 91 ft. • CBX15050X: 50 mt - 165 ft.
- Assembled cable with PROEL CMN40 multipair audio cable, n. 1 x CMIL150FV multipin cable mount female socket, 32 XLR 3-pole cable mount male plugs and 8 XLR 3-pole cable mount female sockets. CBX15030X: 30 mt - 91 ft. • CBX15050X: 50 mt - 165 ft.



PBX15030X - PBX15050X

- Cavo assemblato con cavo audio multipolare PROEL CMN40 terminante con n. 1 presa volante multipolare CMIL150FV e n. 1 spina volante multipolare CMIL150MV. PBX15030X: 30 mt - 91 ft. • PBX15050X: 50 mt - 165 ft.
- Assembled cable with PROEL CMN40 multipair audio cable ending with n. 1 x CMIL150FV multipin cable mount female socket and n. 1 x CMIL150MV multipin cable mount male plug. PBX15030X: 30 mt - 91 ft. • PBX15050X: 50 mt - 165 ft.



BOX4008S

- Stage Box con N. 40 prese da pannello XLR 3 poli, N. 8 spine da pannello XLR 3 poli, N. 1 spina da pannello multipolare CMIL150MP.
- Stage box with 40 XLR 3-pole panel mount female sockets, 8 XLR 3-pole panel mount male plugs, n. 1 x CMIL150MP multipin panel mount male plug.

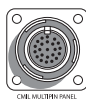
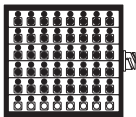

32 XLR IN

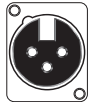

8 XLR OUT



FBX4008

- Cavo assemblato con cavo audio multipolare PROEL CMN48 terminante con n. 1 presa volante multipolare CMIL150FV, n. 40 spine volanti XLR 3 poli e n. 8 prese volanti XLR 3 poli. FBX4008: 2 mt - 6.6 ft.
- Assembled cable with PROEL CMN48 multipair audio cable ending with n. 1 x CMIL150FV multipin cable mount female socket, 40 XLR 3-pole cable mount male plugs and 8 XLR 3-pole cable mount female sockets. FBX4008: 2 mt - 6.6 ft.

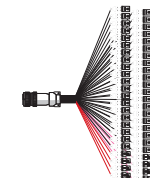

CBX15030XL - CBX15050XL

- Cavo assemblato con cavo audio multipolare PROEL CMN48, n. 1 presa volante multipolare CMIL150FV, n. 40 spine volanti XLR 3 poli e n. 8 prese volanti XLR 3 poli. CBX15030XL: 30 mt - 91 ft. • CBX15050XL: 50 mt - 165 ft.
- Assembled cable with PROEL CMN48 multipair audio cable, n. 1 x CMIL150FV multipin cable mount female socket, 40 XLR 3-pole cable mount male plugs and 8 XLR 3-pole cable mount female sockets. CBX15030XL: 30 mt - 91 ft. • CBX15050XL: 50 mt - 165 ft.



PBX15030XL - PBX15050XL

- Cavo assemblato con cavo audio multipolare PROEL CMN48 terminante con n. 1 presa volante multipolare CMIL150FV e n. 1 spina volante multipolare CMIL150MV. PBX15030XL: 30 mt - 91 ft. • PBX15050XL: 50 mt - 165 ft.
- Assembled cable with PROEL CMN48 multipair audio cable ending with n. 1 x CMIL150FV multipin cable mount female socket and n. 1 x CMIL150MV multipin male plug. PBX15030XL: 30 mt - 91 ft. • PBX15050XL: 50 mt - 165 ft.



PROFESSIONAL AUDIO STAGE BOXES "SN" SERIES

AUDIO SYSTEMS



Rear view
With splitting
Mode example

* custom model

SPLITTING MODE

• "SN" series is also available with a second rear multipin connector, parallel to the first one for monitor systems.

SNBOX16 SPLITTING MODE

- Code: **SPLIT16**
- Connector: CMIL85MP (included)

SNBOX24 SPLITTING MODE

- Code: **SPLIT24**
- Connector: CMIL150MP (included)

SNBOX32 SPLITTING MODE

- Code: **SPLIT32**
- Connector: CMIL150MP (included)

SNBOX40 SPLITTING MODE

- Code: **SPLIT40**
- Connector: CMIL150MP (included)

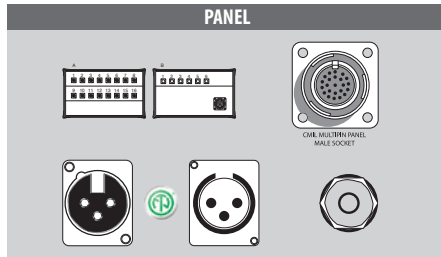

SN



• Ideato per professionisti che richiedono sistemi audio di alta qualità per il routing dei segnali audio nelle varie applicazioni. I connettori multipolari CMIL sono con attacco a baionetta che consente una facile disconnessione dallo stage box. Assemblato con cavi multipolari professionali serie CMT schermati individualmente. Lo Stage Box serie "SN" è dotato di connettori in ingresso ed uscita sul pannello frontale o posteriore del box. Questi sistemi possono essere realizzati anche con l'apporto di avvolgitori serie AV.

• Designed for professionals requiring high-quality audio systems for audio signals routing in different applications. CMIL multipin connectors are bayonet mounted, allowing an easy disconnection from stage box. Assembled with CMT series professional multipair cables, individually shielded. "SN" series Stage Box is fitted with input and output connectors on the front or rear box panel. These systems can be made also with the supply of AV series cable drums.

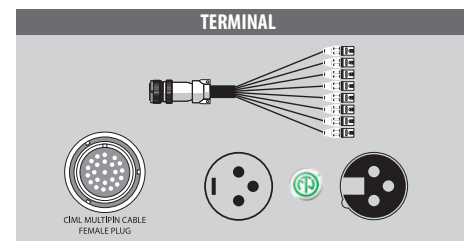
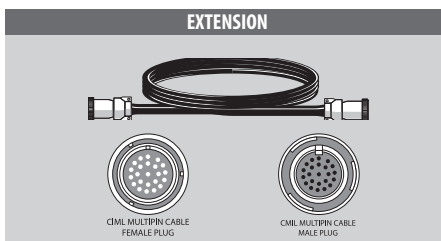
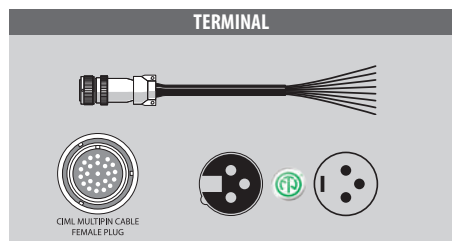

PROFESSIONAL AUDIO STAGE BOXES "SN" SERIES

AUDIO SYSTEMS

SNBOX16

- Stage Box con n. 16 prese da pannello XLR neutrik 3 poli (NC3FDLX), n. 6 spine da pannello XLR neutrik 3 poli (NC3MDLX), n. 1 spina da pannello CMIL85MP sul retro.
- Stage Box with 16 Neutrik XLR 3-pole panel mount female sockets (NC3FDLX), 6 Neutrik XLR 3-pole panel mount male plugs (NC3MDLX), n. 1 x CMIL85MP panel mount male plug on the rear panel.



STR1606

- Cavo assemblato con cavo audio multipolare PROEL CMT24 terminante con n. 1 presa volante multipolare CMIL85FV, n. 16 spine volanti XLR 3 poli (NC3MXX) e n. 6 prese volanti XLR 3 poli (NC3FXX). STR1606: 2 mt - 6.6 ft.
- Assembled cable with PROEL CMT24 multipair audio cable ending with n. 1 x CMIL85FV multipin cable mount female socket, 16 XLR 3-pole cable mount male plugs (NC3MXX) and 6 XLR 3-pole cable mount female sockets (NC3FXX). STR1606: 2 mt - 6.6 ft.

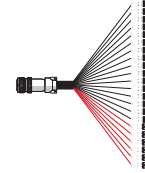

CV8530X - CV8550X

- Cavo assemblato con cavo audio multipolare PROEL CMT24, n. 1 presa volante multipolare CMIL85FV, n. 16 spine volanti XLR 3 poli (NC3MXX) e n. 6 prese volanti XLR 3 poli (NC3FXX). CV8530X: 30 mt - 91 ft. • CV8550X: 50 mt - 165 ft.
- Assembled cable with PROEL CMT24 multipair audio cable, n. 1 x CMIL85FV multipin cable mount female socket, 16 XLR 3-pole cable mount male plugs (NC3MXX) and 6 XLR 3-pole cable mount female sockets (NC3FXX). CV8530X: 30 mt - 91 ft. • CV8550X: 50 mt - 165 ft.



PR8530X - PR8550X

- Cavo assemblato con cavo audio multipolare PROEL CMT24 terminante con n. 1 presa volante multipolare CMIL85MV, n. 1 spina volante multipolare CMIL85MV. PR8530X: 30 mt - 91 ft. • PR8550X: 50 mt - 165 ft.
- Assembled cable with PROEL CMT24 multipair audio cable ending with n. 1 x CMIL85FV multipin cable mount female socket and n. 1 x CMIL85MV multipin cable mount male plug. PR8530X: 30 mt - 91 ft. • PR8550X: 50 mt - 165 ft.



SNBOX24

- Stage Box con n. 24 prese da pannello XLR neutrik 3 poli (NC3FDLX), n. 8 spine da pannello XLR neutrik 3 poli (NC3MDLX), n. 1 spina da pannello CMIL150MP sul retro.
- Stage Box with 24 Neutrik XLR 3-pole panel mount female sockets (NC3FDLX), 8 Neutrik XLR 3-pole panel mount male plugs (NC3MDLX), n. 1 x CMIL150MP panel mount male plug on the rear panel.

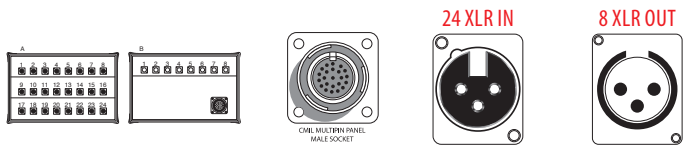

STR2408

- Cavo assemblato con cavo audio multipolare PROEL CMT32 terminante con n. 1 presa volante multipolare CMIL150FV, n. 24 spine volanti XLR 3 poli (NC3MXX) e n. 8 prese volanti XLR 3 poli (NC3FXX). STR2408: 2 mt - 6.6 ft.
- Assembled cable with PROEL CMT32 multipair audio cable ending with n. 1 x CMIL150FV multipin cable mount female socket, 24 XLR 3-pole cable mount male plugs (NC3MXX) and 8 XLR 3-pole cable mount female sockets (NC3FXX). STR2408: 2 mt - 6.6 ft.

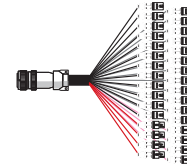

CV15030 - CV15050

- Cavo assemblato con cavo audio multipolare PROEL CMT32, n. 1 presa volante multipolare CMIL150FV, n. 24 spine volanti XLR 3 poli (NC3MXX) e n. 8 prese volanti XLR 3 poli (NC3FXX). CV15030: 30 mt - 91ft. • CV15050: 50 mt - 165 ft.
- Assembled cable with PROEL CMT32 multipair audio cable, n. 1 x CMIL150FV multipin cable mount female socket, 24 XLR 3-pole cable mount male plugs (NC3MXX) and 8 XLR 3-pole cable mount female sockets (NC3FXX). CV15030: 30 mt - 91 ft. • CV15050: 50 mt - 165 ft.



PR15030 - PR15050

- Cavo assemblato con cavo audio multipolare PROEL CMT32 terminante con n. 1 presa volante multipolare CMIL150FV e n. 1 spina volante multipolare CMIL150MV. PR15030: 30 mt - 91ft. • PR15050: 50 mt - 165 ft.
- Assembled cable with PROEL CMT32 multipair audio cable ending with n. 1 x CMIL150FV multipin cable mount female socket and n. 1 x CMIL150MV multipin cable mount male plug. PR15030: 30 mt - 91 ft. • PR15050: 50 mt - 165 ft.



SNBOX32

- Stage Box con n. 32 prese da pannello XLR neutrik 3 poli (NC3FDLX), n. 8 spine da pannello XLR neutrik 3 poli (NC3MDLX), n. 1 spina da pannello CMIL150MP sul retro.
- Stage Box with 32 Neutrik XLR 3-pole panel mount female sockets (NC3FDLX), 8 Neutrik XLR 3-pole panel mount male plugs (NC3MDLX), n. 1 x CMIL150MP panel mount male plug on the rear panel.

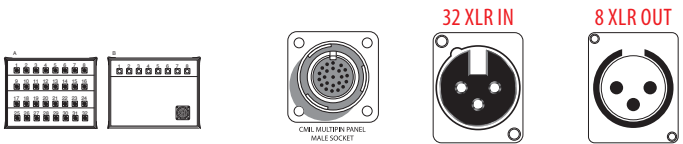

STR3208

- Cavo assemblato con cavo audio multipolare PROEL CMT40 terminante con n. 1 presa volante multipolare CMIL150FV, n. 32 spine volanti XLR 3 poli (NC3MXX) e n. 8 prese volanti XLR 3 poli (NC3FXX). STR3208: 2 mt - 6.6 ft.
- Assembled cable with PROEL CMT40 multipair audio cable ending with n. 1 x CMIL150FV multipin cable mount female socket, 32 XLR 3-pole cable mount male plugs (NC3MXX) and 8 XLR 3-pole cable mount female sockets (NC3FXX). STR3208: 2 mt - 6.6 ft.

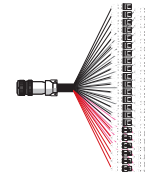

CV15030X - CV15050X

- Cavo assemblato con cavo audio multipolare PROEL CMT40, n. 1 presa volante multipolare CMIL150FV, n. 32 spine volanti XLR 3 poli (NC3MXX) e n. 8 prese volanti XLR 3 poli (NC3FXX). CV15030X: 30 mt - 91ft. • CV15050X: 50 mt - 165 ft.
- Assembled cable with PROEL CMT40 multipair audio cable, n. 1 x CMIL150FV multipin cable mount female socket, 32 XLR 3-pole cable mount male plugs (NC3MXX) and 8 XLR 3-pole cable mount female sockets (NC3FXX). CV15030X: 30 mt - 91 ft. • CV15050X: 50 mt - 165 ft.



PR15030X - PR15050X

- Cavo assemblato con cavo audio multipolare PROEL CMT40 terminante con n. 1 presa volante multipolare CMIL150FV e n. 1 spina volante multipolare CMIL150MV. PR15030X: 30 mt - 91ft. • PR15050X: 50 mt - 165 ft.
- Assembled cable with PROEL CMT40 multipair audio cable ending with n. 1 x CMIL150FV multipin cable mount female socket and n. 1 x CMIL150MV multipin cable mount male plug. PR15030X: 30 mt - 91 ft. • PR15050X: 50 mt - 165 ft.



PROFESSIONAL AUDIO STAGE BOXES "SN" SERIES

AUDIO SYSTEMS

SNBOX40

- Stage Box con n. 40 prese da pannello XLR neutrik 3 poli (NC3FDLX), n. 8 spine da pannello XLR neutrik 3 poli (NC3MDLX), n. 1 spina da pannello CMIL150MP sul retro.
- Stage Box with n. 40 Neutrik XLR 3-pole panel mount female sockets (NC3FDLX), n. 8 Neutrik XLR 3-pole panel mount male plugs (NC3MDLX), n. 1 CMIL150MP panel mount multipin male plug on the rear panel.

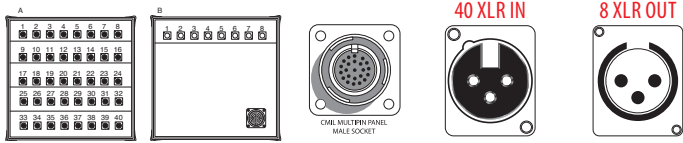

STR4008

- Cavo assemblato con cavo audio multipolare PROEL CMN48 terminante con n. 1 presa volante multipolare CMIL150FV, n. 40 spine volanti XLR 3 poli e n. 8 prese volanti XLR 3 poli. STR4008: 2 mt - 6.6 ft.
- Assembled cable with PROEL CMN48 multipair audio cable ending with n. 1 CMIL150FV multipin cable mount female socket, n. 40 XLR 3-pole cable mount male plugs and n. 8 XLR 3-pole cable mount female sockets. STR4008: 2 mt - 6.6 ft.

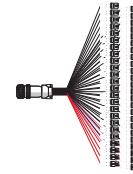

CV15030XL - CV15050XL

- Cavo assemblato con cavo audio multipolare PROEL CMN48, n. 1 presa volante multipolare CMIL150FV, n. 40 spine volanti XLR 3 poli e n. 8 prese volanti XLR 3 poli. CV15030XL: 30 mt - 91ft. • CV15050XL: 50 mt. - 165 ft.
- Assembled cable with PROEL CMN48 multipair audio cable, n. 1 CMIL150FV multipin cable mount female socket, 40 XLR 3-pole cable mount male plugs and 8 XLR 3-pole cable mount female sockets. CV15030XL: 30 mt - 91 ft. • CV15050XL: 50 mt - 165 ft.



PBX15030XL - PBX15050XL

- Cavo assemblato con cavo audio multipolare PROEL CMN48 terminante con n. 1 presa volante multipolare CMIL150FV e n. 1 spina volante multipolare CMIL150MV. PBX15030XL: 30 mt - 91ft. • PBX15050XL: 50 mt. - 165 ft.
- Assembled cable with PROEL CMN48 multipair audio cable ending with n. 1 CMIL150FV multipin cable mount female socket and n. 1 CMIL150MV multipin male plug. PBX15030XL: 30 mt - 91 ft. • PBX15050XL: 50 mt - 165 ft.



MULTIPIN AUDIO CONNECTORS BAYONET "CMIL" SERIES

AUDIO SYSTEMS

• La serie PROEL "CMIL", comprende connettori costruiti in lega di alluminio UNI 5075 lavorati con macchine CNC, sottoposto a trattamenti galvanici con elettrodeposizione di vernice nera (F6) - cataforesi - in accordo alle norme RoHS. La gamma di combinazioni comprende connettori che vanno da 19 a 150 poli. Il sistema di bloccaggio a baionetta a 3 rampe sull'alloggiamento assicura una perfetta tenuta dell'accoppiamento. Contatti a crimpare e a saldare di tipo argentato e dorato. La

connessione del contatto a bassissima resistenza assicura che i segnali audio di linea o microfonici non abbiano attenuazioni o alterazioni. Sono disponibili copriconnettori per proteggere i contatti da sollecitazioni meccaniche.

• PROEL "CMIL" series is made with UNI 5075 / UNI 6060 aluminium alloy worked with CNC machines, subjected to galvanic treatment and finished according to MIL standards. It features a variety of combinations ranging from 19 to 150 poles. Bayonet

locking system with 3 ramps on the housing grants a perfect mating. Crimp and solder contacts, silver or gold plated. Contact connection low resistance grants line or microphone audio signals not to have attenuations or alterations. Connector covers are available to protect contacts against mechanical stress. Electrodeposition of black paint (F6) cataforesis in accordance with RoHS. Working voltage: 700Vdc / 500Vac class A / 250Vdc / 200Vac class I. Working temperature: - 55 / + 125 C°.

CMIL19MV

• Spina volante in lega di alluminio verniciato con innesto a baionetta, n. 19 contatti argentati.
• Aluminium cable mount male plug with bayonet locking system, n. 19 silver plated contacts



CMIL19MV

19
PIN



CMIL19FP

• Presa da pannello in lega di alluminio verniciato con innesto a baionetta, n. 19 contatti argentati.
• Aluminium panel mount female receptacle with bayonet locking system, n. 19 silver plated contacts.



CMIL19FP

19
PIN



TPM19

• Tappo di chiusura per presa con innesto a baionetta, n. 19 contatti.
• Closing cap for n. 19 contacts female socket with bayonet locking system. Equipped with nylon covered stainless steel rope.



TPM19



CMIL19FV

• Presa volante in lega di alluminio verniciato con innesto a baionetta, n. 19 contatti argentati.
• Aluminium cable mount female socket with bayonet locking system, n. 19 silver plated contacts.



CMIL19FV

19
PIN



CMIL19MP

• Spina da pannello in lega di alluminio verniciato con innesto a baionetta, n. 19 contatti argentati.
• Aluminium panel mount male receptacle with bayonet locking system, n. 19 silver plated contacts.



CMIL19MP

19
PIN



TPF19

• Tappo di chiusura per spina con innesto a baionetta, n. 19 contatti.
• Closing cap for n. 19 contacts male plug with bayonet locking system. Equipped with nylon covered stainless steel rope.



TPF19



CMIL25MV

• Spina volante in lega di alluminio verniciato con innesto a baionetta, n. 25 contatti argentati.
• Aluminium cable mount male plug with bayonet locking system, n. 25 silver plated contacts.



CMIL25MV

25
PIN



CMIL25FP

• Presa da pannello in lega di alluminio verniciato con innesto a baionetta, n. 25 contatti argentati.
• Aluminium panel mount female receptacle with bayonet locking system, n. 25 silver plated contacts.



CMIL25FP

25
PIN



TPM25

• Tappo di chiusura per presa con innesto a baionetta, n. 25 contatti.
• Closing cap for n. 25 contacts female socket with bayonet locking system. Equipped with nylon covered stainless steel rope.



TPM25



MULTIPIN AUDIO CONNECTORS BAYONET "CMIL" SERIES

AUDIO SYSTEMS

CMIL25FV

- Presa volante in lega di alluminio verniciato con innesto a baionetta, n. 25 contatti argentati.
- Aluminium cable mount female socket with bayonet locking system, n. 25 silver plated contacts.



CMIL25FV

25
PIN



CMIL25MP

- Spina da pannello in lega di alluminio verniciato con innesto a baionetta, n. 25 contatti argentati.
- Aluminium panel mount male receptacle with bayonet locking system, n. 25 silver plated contacts.



CMIL25MP

25
PIN



TPF25

- Tappo di chiusura per spina con innesto a baionetta, n. 25 contatti.
- Closing cap for n. 25 contacts male plug with bayonet locking system. Equipped with nylon covered stainless steel rope.



TPF25



CMIL37MV

- Spina volante in lega di alluminio verniciato con innesto a baionetta, n. 37 contatti argentati.
- Aluminium cable mount male plug with bayonet locking system, n. 37 silver plated contacts.



CMIL37MV

37
PIN



CMIL37FP

- Presa da pannello in lega di alluminio verniciato con innesto a baionetta, n. 37 contatti argentati.
- Aluminium panel mount female receptacle with bayonet locking system, n. 37 silver plated contacts.



CMIL37FP

37
PIN



TPM37

- Tappo di chiusura per presa con innesto a baionetta, n. 37 contatti.
- Closing cap for n. 37 contacts female socket with bayonet locking system. Equipped with nylon covered stainless steel rope.



TPM37



CMIL37FV

- Presa volante in lega di alluminio verniciato con innesto a baionetta, n. 37 contatti argentati.
- Aluminium cable mount female socket with bayonet locking system, n. 37 silver plated contacts.



CMIL37FV

37
PIN



CMIL37MP

- Spina da pannello in lega di alluminio verniciato con innesto a baionetta, n. 37 contatti argentati.
- Aluminium panel mount male receptacle with bayonet locking system, n. 37 silver plated contacts.



CMIL37MP

37
PIN



TPF37

- Tappo di chiusura per spina con innesto a baionetta, n. 37 contatti.
- Closing cap for n. 37 contacts male plug with bayonet locking system. Equipped with nylon covered stainless steel rope.



TPF37



CMIL54MV

- Spina volante in lega di alluminio verniciato con innesto a baionetta, n. 54 contatti argentati.
- Aluminium cable mount male plug with bayonet locking system, n. 54 silver plated contacts.



CMIL54MV

54
PIN



CMIL54FP

- Presa da pannello in lega di alluminio verniciato con innesto a baionetta, n. 54 contatti argentati.
- Aluminium panel mount female receptacle with bayonet locking system, n. 54 silver plated contacts.



CMIL54FP

54
PIN



TPM54

- Tappo di chiusura per presa con innesto a baionetta, n. 54 contatti.
- Closing cap for n. 54 contacts female socket with bayonet locking system. Equipped with nylon covered stainless steel rope.



TPM54



CMIL54FV

- Presa volante in lega di alluminio verniciato con innesto a baionetta, n. 54 contatti argentati.
- Aluminium cable mount female socket with bayonet locking system, n. 54 silver plated contacts.



CMIL54FV

54
PIN



CMIL54MP

- Spina da pannello in lega di alluminio verniciato con innesto a baionetta, n. 54 contatti argentati.
- Aluminium panel mount male receptacle with bayonet locking system, n. 54 silver plated contacts.



CMIL54MP

54
PIN



TPF54

- Tappo di chiusura per spina con innesto a baionetta, n. 54 contatti.
- Closing cap for n. 54 contacts male plug with bayonet locking system. Equipped with nylon covered stainless steel rope.



TPF54



MULTIPIN AUDIO CONNECTORS BAYONET "CMIL" SERIES

AUDIO SYSTEMS

CMIL85MV

- Spina volante in lega di alluminio verniciato con innesto a baionetta, n. 85 contatti argentati.
- Aluminium cable mount male plug with bayonet locking system, n. 85 silver plated contacts.



CMIL85MV

85
PIN



CMIL85FP

- Presa da pannello in lega di alluminio verniciato con innesto a baionetta, n. 85 contatti argentati.
- Aluminium panel mount female receptacle with bayonet locking system, n. 85 silver plated contacts.



CMIL85FP

85
PIN



TPM85

- Tappo di chiusura per presa con innesto a baionetta, n. 85 contatti.
- Closing cap for n. 85/100/150 contacts female socket with bayonet locking system. Equipped with nylon covered stainless steel rope.



TPM85



CMIL85FV

- Presa volante in lega di alluminio verniciato con innesto a baionetta, N. 85 contatti argentati.
- Aluminium cable mount female socket with bayonet locking system, n. 85 silver plated contacts.



CMIL85FV

85
PIN



CMIL85MP

- Spina da pannello in lega di alluminio verniciato con innesto a baionetta, N. 85 contatti argentati.
- Aluminium panel mount male receptacle with bayonet locking system, n. 85 silver plated contacts.



CMIL85MP

85
PIN



TPF85

- Tappo di chiusura per spina con innesto a baionetta, N. 85 contatti.
- Closing cap for n. 85/100/150 contacts male plug with bayonet locking system. Equipped with nylon covered stainless steel rope.



TPF85



CMIL150MV

- Spina volante in lega di alluminio verniciato con innesto a baionetta, N. 150 contatti dorati.
- Aluminium cable mount male plug with bayonet locking system, n. 150 gold plated contacts.



CMIL150MV

150
PIN



CMIL150FP

- Presa da pannello in lega di alluminio verniciato con innesto a baionetta, N. 150 contatti dorati.
- Aluminium panel mount female receptacle, n. 150 gold plated contacts.



CMIL150FP

150
PIN



TPM85

- Tappo di chiusura per presa con innesto a baionetta, N. 150 contatti.
- Closing cap for n. 85/100/150 contacts female socket with bayonet locking system. Equipped with nylon covered stainless steel rope.



TPM85



CMIL150FV

- Presa volante in lega di alluminio verniciato con innesto a baionetta, N. 150 contatti dorati.
- Aluminium cable mount female socket with bayonet locking system, n. 150 gold plated contacts.



CMIL150FV

150
PIN



CMIL150MP

- Spina da pannello in lega di alluminio verniciato con innesto a baionetta, N. 150 contatti dorati.
- Aluminium panel mount male receptacle with bayonet locking system, n. 150 gold plated contacts.



CMIL150MP

150
PIN



TPF85

- Tappo di chiusura per spina con innesto a baionetta, N. 150 contatti.
- Closing cap for n. 85/100/150 contacts male plug with bayonet locking system. Equipped with nylon covered stainless steel rope.



TPF85



• La sezione Proel "Electronics", specificatamente ideata da e per professionisti del settore, comprende le serie di pedali volume per strumenti musicali e tastiere, nonché quelli di comando e di controllo. Il dipartimento di Ricerca e Sviluppo Proel, sempre alla ricerca di prodotti che possano rappresentare la risposta a tutte le esigenze del mercato, ne ha rivisitato e migliorato le caratteristiche tecniche standard.

• Proel "Electronics" section, specifically conceived by and for professionals, includes musical instruments and keyboards volume pedals, as well as control and command pedals. Proel department of Research and Development has revised and enhanced their technical standards, in order to find and create products able to satisfy every market request.



INSTRUMENT VOLUME PEDALS

ELECTRONICS

- Serie di pedali volume ed espressione della serie Golden Feet, caratterizzati dall'esclusivo design. La struttura, realizzata in ABS, è provvista di rinforzi in metallo per conferire maggiore massa e quindi stabilità durante l'utilizzo. Rivestimento superiore antiscivolo per una perfetta aderenza della calzatura al pedale e base completamente gommata per un'ottima aderenza al terreno.

- Golden Feet series of volume and expression pedals, featuring exclusive design. The structure, made of ABS, is provided with metal reinforcements to grant greater mass and stability during use. Upper non-slip coated surface for a snug fit of the shoe to the pedal and fully rubberized bottom base for a good grip on the floor.



GF12



GF14

GF12

- Pedale volume Mono adatto per chitarre e strumenti musicali con uscita mono ad alta impedenza. Dotato di connettori ingresso ed uscita da 6.3mm e potenziometro da 100K Ohm per una precisa regolazione del segnale.
- Volume Mono Pedal, suitable for guitars and musical instruments with high impedance mono output. Featuring 6,3 mm mono input socket and (from the instrument) and 6,3 mm mono output socket (to the amp). It also features a 100k Ohm potentiometer for a sharp and optimal volume trimming of the incoming signal. (cables not included).

GF14

- Pedale volume Stereo adatto per chitarre e strumenti musicali con uscita ad alta impedenza. Si caratterizza per i due ingressi e le due uscite di segnale completamente indipendenti, su connettori da 6.3mm. Il pedale controlla un potenziometro da 100K Ohm, mentre un secondo potenziometro laterale, permette la regolazione del massimo livello del segnale in uscita.
- Stereo Volume Control pedal, features two completely independent inputs and two outputs. It also features a 100k Ohm potentiometer controlled by the pedal, and a second, lateral potentiometer sets maximum output level for a sharp and accurate output signal volume of the guitars.

| TECH INFO | GF12 |
|-----------------|---|
| Pedal structure | Thermoplastic ABS with weighted galvanized base |
| Impedance | 100 Kohm |
| Inputs | nr. 1 Ø 6.3 mm mono jack female socket |
| Outputs | nr.1 Ø 6.3 mm mono jack female socket |

| TECH INFO | GF14 |
|-----------------|---|
| Pedal structure | Thermoplastic ABS with weighted galvanized base |
| Impedance | 1x100 Kohm / 1x20 Kohm |
| Inputs | nr. 2 Ø 6.3 mm mono jack female sockets |
| Outputs | nr. 2 Ø 6.3 mm mono jack female sockets |
| Controls | volume adjustment |

KEYBOARD VOLUME PEDALS

ELECTRONICS



GF12L



GF14L



GF16L

GF12L

- Pedale Volume Mono adatto per tastiere ed altri strumenti con uscite "line level" a media impedenza. Connettori ingresso ed uscita da 6,3mm e potenziometro da 20K Ohm per una precisa regolazione del segnale in ingresso.
- Mono Pedal with medium impedance, similar features to GF12, but for use with electronic keyboards or other instruments provided with "line output". It also features a 20k Ohm potentiometer for a sharp and optimal volume trimming of the incoming signal. Connection is made between mono input 6,3 mm. and from mono output 6,3 mm. to the amp (cables not included).

GF14L

- Pedale volume Stereo adatto per tastiere, digital pianos ed altri strumenti con uscite "line level". Si caratterizza per i due ingressi e le due uscite di segnale completamente indipendenti, su connettori da 6.3mm. Il pedale controlla un potenziometro da 20K Ohm, mentre un secondo potenziometro laterale, permette la regolazione del massimo livello del segnale in uscita.
- The GF14L model is a Stereo Pedal with medium impedance; similar features to GF14, but for use with keyboards and digital/stage pianos. It uses a 20k Ohm potentiometer actuated by the pedal, and a lateral 100k Ohm potentiometer fixes the max output level (cable not included).

GF16L

- Il Pedale Espressione GF16L utilizza un potenziometro da 20KOhm per una precisa regolazione del volume di tastiere e digital pianos. E' fornito con cavo da 2 metri terminato con jack stereo da 6,3mm per la connessione all'uscita volume od espressione della tastiera.
- The Golden Feet Series Expression Pedal, features a 20k Ohm potentiometer allowing a precise volume regulation for keyboards and digital/stage pianos. It is equipped with 2 mt cable length, terminated with \varnothing 6,3 mm standard mono moulded Gold plated jack male plug, for connection to the volume or expression output of the keyboard.



| TECH INFO | GF12L | GF14L | GF16L |
|------------------------|---|---|---|
| Pedal structure | Thermoplastic ABS with weighted galvanized base | Thermoplastic ABS with weighted galvanized base | Thermoplastic ABS with weighted galvanized base |
| Impedance | 20 Kohm | 2x20 Kohm | 20 Kohm |
| Inputs | nr. 1 \varnothing 6.3 mm mono jack female sockets | nr. 2 \varnothing 6.3 mm mono jack female sockets | nr. 1 2.00 mt cable with \varnothing 6.3 mm mono jack male plug |
| Outputs | nr. 1 \varnothing 6.3 mm mono jack female socket | nr. 2 \varnothing 6.3 mm mono jack female sockets | - |
| Controls | - | volume adjustment | - |

COMMAND & CONTROL PEDALS

ELECTRONICS



GF01



GF29



GF28



GF01

- Pedale in metallo cromato di controllo "SUSTAIN" con interruttore per invertire la polarità, in robusto ABS con base metallica con piedini antiscivolo, dotato di cavo di 2.00 mt terminante con spina jack mono \varnothing 6.3 mm.
- Professional Golden Feet Damper Pedal. Thanks to its unique design, the gold finishing lever and the high durability structure, the GF01 guarantees the maximum quality standard. It perfectly fits with keyboards, synths and digital pianos; it features selectable polarity and it is equipped with 2mt cable terminated with \varnothing 6,3 mm standard mono moulded Gold plated jack male plug.

GF28

- Pedale di comando "ON/OFF", in robusto ABS e base rinforzata, dotato di cavo di 2.00 mt terminante con spina jack mono \varnothing 6.3 mm.
- Golden Feet Series heavy duty ABS "ON/OFF" command pedal supplied with 2mt cable terminated with \varnothing 6,3 mm standard mono moulded Gold plated jack male plug.

GF29

- Pedale di controllo "SUSTAIN" con interruttore per invertire la polarità, in robusto ABS e base rinforzata, dotato di cavo di 2.00 mt terminante con spina jack mono \varnothing 6.3 mm.
- Golden Feet Series heavy duty ABS DAMPER/HOLD/SUSTAIN control pedal for keyboards, synths, digital pianos. It features polarity inversion switch, supplied with 2mt cable terminated with \varnothing 6,3 mm standard mono moulded Gold plated jack male plug.

| TECH INFO | GF01 | GF28 | GF29 |
|------------------------|--|---|---|
| Pedal structure | Thermoplastic ABS/Metal chassis | Thermoplastic ABS with reinforced base | Thermoplastic ABS with reinforced base |
| Type | "SUSTAIN" temporary switch | "ON/OFF" switch | "SUSTAIN" temporary switch |
| Controls | Polarity switch | None | None |
| Outputs | nr.1 2.00 mt cable with \varnothing 6.3 mm mono jack male plug | 2.00 mt cable with \varnothing 6.3 mm mono jack male plug | 2.00 mt cable with \varnothing 6.3 mm mono jack male plug |
| Rating | 0.3A/30V DC | 0.3A/30V DC | 0.3A/30V DC |

COMMAND & CONTROL PEDALS

ELECTRONICS



GF20

GF20

- Pedale di controllo "SUSTAIN" con interruttore per invertire la polarità, in robusto ABS e alluminio con piedini antiscivolo e scanalature ad incastro.
- Golden Feet Series new "SUSTAIN" control pedal with polarity inversion switch, heavy duty ABS/Aluminium with anti-skid feet and recessed slots.

GF22

- Pedale di comando "ON/OFF" in robusto ABS e alluminio con piedini antiscivolo e scanalature ad incastro.
- Golden Feet Series new "ON/OFF" command pedal, heavy duty ABS/Aluminium with anti-skid feet and recessed slots.

GF24

- Pedale di controllo "SUSTAIN" con interruttore per invertire la polarità, in robusto ABS e alluminio con piedini antiscivolo e scanalature ad incastro, dotato di cavo di 2.00 mt terminante con spina jack mono Ø 6.3 mm.
- Golden Feet Series new "SUSTAIN" control pedal with polarity inversion switch, heavy duty ABS/Aluminium with anti-skid feet and recessed slots, supplied with 2.00 mt lead terminated with mono jack male plug Ø 6.3 mm.

GF26

- Pedale di comando "ON/OFF" in robusto ABS e alluminio con piedini antiscivolo e scanalature ad incastro, dotato di cavo di 2.00 mt terminante con spina jack mono Ø 6.3 mm.
- Golden Feet Series new "ON/OFF" command pedal, heavy duty ABS/Aluminium with anti-skid feet and recessed slots, supplied with 2.00 mt lead terminated with mono jack male plug Ø 6.3 mm.



GF22

| TECH INFO | GF20 | GF24 |
|------------------------|--|--|
| Pedal Structure | Thermoplastic ABS/Aluminium with anti-skid feet and recessed slots | Thermoplastic ABS/Aluminium with anti-skid feet and recessed slots |
| Type | "SUSTAIN" temporary switch | "SUSTAIN" temporary switch |
| Controls | Polarity switch | Polarity switch |
| Outputs | n. 1 x Ø 6.3 mm mono jack female socket | 2.00 mt cable with Ø 6.3 mm mono jack male plug |
| Rating | 0.3A/30V DC | 0.3A/30V DC |

| TECH INFO | GF22 | GF26 |
|------------------------|--|--|
| Pedal structure | Thermoplastic ABS/Aluminium with anti-skid feet and recessed slots | Thermoplastic ABS/Aluminium with anti-skid feet and recessed slots |
| Type | "ON/OFF" alternate switch | "ON/OFF" alternate switch |
| Controls | LED diode | LED diode |
| Outputs | n. 1 x Ø 6.3 mm mono jack female socket | 2.00 mt cable with Ø 6.3 mm mono jack male plug |
| Rating | 0.3A/30V DC | 0.3A/30V DC |
| Current drain | < 10 mA (LED) | < 10 mA (LED) |
| Power | 9 Volt battery (not included) | 9 Volt battery (not included) |



GF24



GF26

ELECTRIC DISTRIBUTION

• In Proel siamo orgogliosi di offrire prodotti di qualità e la nostra gamma di distribuzione elettrica non fa eccezione. Tutti i prodotti di questa linea sono progettati e realizzati utilizzando componenti di alta qualità in grado di garantire prestazioni, affidabilità e sicurezza. Grazie a una particolare cura e attenzione al design e agli impianti di produzione interna Proel è in grado di offrire sistemi di distribuzione elettrica su misura per le specifiche e le esigenze del cliente. Tutti i prodotti sono realizzati secondo le norme di riferimento CEI e sono conformi alle direttive comunitarie in materia di compatibilità elettromagnetica. Tutti i prodotti sono inoltre conformi alle direttive comunitarie in materia di bassa tensione e sono dotati del marchio.

• At Proel we pride ourselves in offering quality products and our electric distribution product is no exception. All of our electric distribution products are designed and manufactured using the highest quality components ensuring performance, reliability and safety. Using our state of the art in house design and manufacturing facilities Proel can offer bespoke electric distribution systems to customer specifications and requirements. All products are manufactured to CEI regulations and compliant with Community Directives on electromagnetic compatibility. All products are also compliant with Community Directives on low voltage and feature the CE mark.

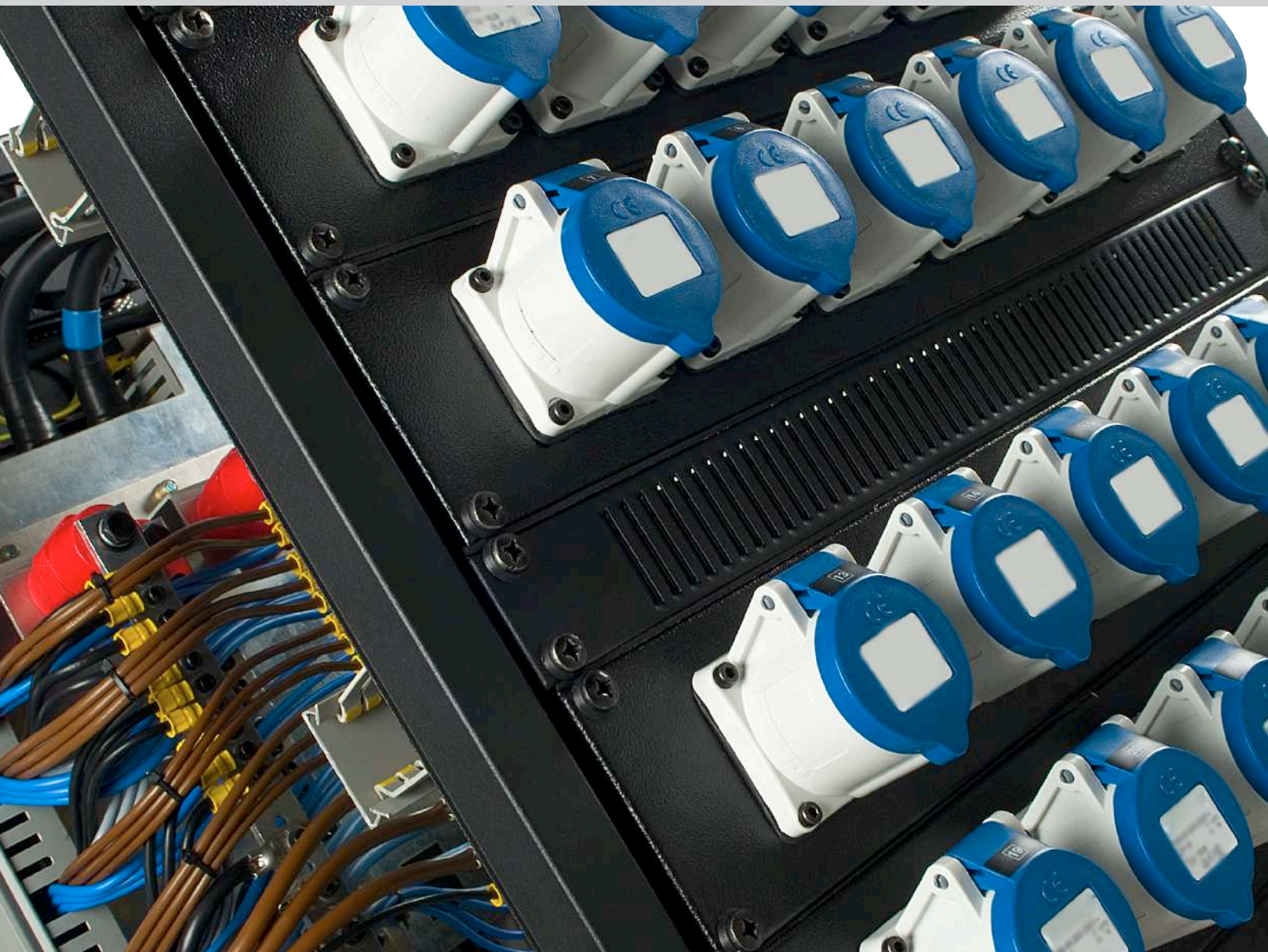

Made in Italy
Neutrik Connector



POWER DISTRIBUTION BOXES "ELBOX" SERIES

ELECTRIC DISTRIBUTION

• La serie "ELBOX" PROEL rappresenta un ulteriore risultato positivo della costante ricerca attuata da PROEL per soddisfare tutte le esigenze del mercato in continua evoluzione. Questa nuova serie di POWER BOXES portatili è realizzata mediante l'impiego di strutture in materiale termoplastico molto leggero con una straordinaria resistenza agli urti, agli acidi ed ai raggi UV per impieghi in condizioni gravose. La temperatura di utilizzo dei box può variare da -20°C fino a +50°C. Le maniglie integrate nella struttura assicurano una pratica portabilità ed inoltre è possibile sovrapporre più box delle stesse dimensioni grazie al pratico sistema d'impilaggio. Tutte le apparecchiature utilizzate per i comandi e le connessioni, risultano essere protette dalla sporgenza della struttura. Abbiamo previsto una gamma diversificata di prodotti con diversi gradi di protezione IP e configurazioni, ma nell'ottica di offrire sempre un servizio dedicato alla clientela, si possono realizzare anche configurazioni custom.

• The PROEL "ELBOX" series is the result of ongoing research aimed at meeting the requirements of a constantly evolving market. This new series of portable Power Boxes is realized with structures made from lightweight, yet extremely resistant thermoplastic, which are resistant to impact, acid and UV rays providing a product suitable for use in the most demanding conditions. The operational temperature of the boxes can range from a remarkable -20 °C up to +50 °C. Integrated handles make the boxes extremely portable and a practical stacking system allows you to stack multiple boxes of the same size. The connection panels are recessed into the body of the structure providing extra protection to all of the commands, controls and connections. The ELBOX series is a complete and versatile range of different formats and different degrees of IP protection, with custom configurations available on request.



ELBOX5532

ELBOX5532



• Power box portatile IP55 in materiale plastico antiurto. Dotato di: ingresso con spina diretta CEE 32A - 3P+N+T - IP67 - 400V ~ - h6 (DIN VDE 0623, EN 60309-2) con protezione differenziale 4P 0.03A 415V IEC 61008-1/ rilancio per mezzo di presa inclinata CEE 32A - 3P+N+T - IP67 - 400V ~ - h6 (DIN VDE 0623, EN 60309-2)/interruttore magnetotermico 32A 400V ~ 4P (3P+N) dedicato/n. 6 uscite su prese CEE 16A - 2P+T - IP44 - 230V ~ - h6 (DIN VDE 0623, EN 60309-2)/n. 3 uscite su prese Schuko 16A - 2P+T - IP54 - 230V ~ (DIN 49440-1), tutte con interruttore magnetotermico 16A - 2P (1P+N) dedicato. Tutti i comandi sono posizionati sotto sportelli in materiale plastico con protezione IP67. Portata massima 32A ~.

• Portable IP55 Power Box in an impact resistant plastic structure. Featuring: Straight input connector EEC 32A - 3P + N + T - IP67 - 400V ~ - h6 (DIN VDE 0623, EN 60309-2) with differential protection 4P 0.03A 415V IEC 61008-1/ link-out through 32A EEC angled socket - 3P + N + T - IP67 - 400V ~ - h6 (DIN VDE 0623, EN 60309-2) / 400V ~ 32A MCB 4P (3P + N) dedicated / 6 x 16A EEC outputs 16A - 2P + T - IP44 - 230V ~ - h6 (DIN VDE 0623, EN 60309-2) / 3 x Schuko outputs 16A - 2P + T - IP54 - 230V ~ (DIN 49440-1), all with dedicated MCB 16A - 2P (1P + N). All controls are located under in plastic covers providing IP67 protection. Maximum load 32A ~.

TECH INFO

ELBOX5532

Input

- 32A - 3P+N+T - IP67 - 400V ~ - h6 plug (DIN VDE 0623, EN 60309-2) with 4P - 415V - 0.03A - IEC 61008-1 residual current circuit breaker (RCCB)

Output

- n. 1 x 32A - 3P+N+T - IP67 - 400V ~ - h6 socket (DIN VDE 0623, EN 60309-2) with dedicated circuit breaker switch
 - n. 6 x 16A - 2P+T - IP44 - 230V ~ - h6 socket (DIN VDE 0623, EN 60309-2) with dedicated circuit breaker switch
 - n. 3 x 16A - 2P+T - IP54 - 230V ~ - h6 Schuko socket (DIN VDE 0623, EN 60309-2) with dedicated circuit breaker switch



POWER DISTRIBUTION BOXES "ELBOX" SERIES

ELECTRIC DISTRIBUTION



ELBOX5563



ELBOX6563



ELBOX5563

• Power box portatile IP55 in materiale plastico antiurto. Dotato di: ingresso con spina diretta CEE 63A - 3P+N+T - IP67 - 400V ~ - h6 (DIN VDE 0623, EN 60309-2) con protezione differenziale 4P 0.03A 400V ~ IEC61008-1/ n. 2 uscite su prese CEE 32A - 3P+N+T - IP67 - 400V ~ - h6 (DIN VDE 0623, EN 60309-2)/ n° 2 interruttori magnetotermici 32A 4P (3P+N) 400V ~/ n. 9 uscite su prese CEE 16A - 2P+T - IP44 - 230V ~ - h6 (DIN VDE 0623, EN 60309-2) tutte con interruttore magnetotermico 16A 2P(1P+N) dedicato. Tutte le uscite sono protette da differenziale 4P 0.03A 415V ~. Tutti i comandi sono posizionati sotto sportelli in materiale plastico con protezione IP67. Portata massima 63A.

• Portable IP55 Power Box in an impact resistant plastic structure. Featuring: Straight input connector CEE 63A - 3P + N + T - IP67 - 400V ~ - h6 (DIN VDE 0623, EN 60309-2) with differential protection 4P 0.03A 400V ~ IEC61008-1 / 2 x 32A EEC socket outputs - 3P + N + T - IP67 - 400V ~ - h6 (DIN VDE 0623, EN 60309-2) / 2 x MCB 32A 4P (3P + N) 400V ~ / 9 x 16A EEC outputs - 2P + T - IP44 - 230V ~ - h6 (DIN VDE 0623, EN 60309-2) all with dedicated 16A MCB 2P (1P + N). All outputs are protected from differential 4P 0.03A 415V ~. All controls are located under in plastic covers providing IP67 protection. Maximum load 63A.



ELBOX6563

• Power box portatile IP65 in materiale plastico antiurto. Dotato di: ingresso con spina diretta CEE 63A - 3P+N+T - IP67 - 400V ~ - h6 (DIN VDE 0623, EN 60309-2) con protezione differenziale 4P 0.03A 400V ~ IEC 61008-1/ n. 1 uscita su presa CEE 32A - 3P+N+T - IP67 - 400V ~ - h6 (DIN VDE 0623, EN 60309-2)/ n° 1 interruttore magnetotermico 32A 4P (3P+N) 400V ~/ n. 6 uscite su prese CEE 16A - 2P+T - IP67 - 230V ~ - h6 (DIN VDE 0623, EN 60309-2) tutte con interruttore magnetotermico 16A 2P(1P+N) dedicato. Tutte le uscite sono protette da differenziale 4P 0.03A 415V ~. Tutti i comandi sono posizionati sotto sportelli in materiale plastico con protezione IP67. Portata massima 63A.

• Portable IP55 Power Box in an impact resistant plastic structure. Featuring: Straight 63A EEC input connector - 3P + N + T - IP67 - 400V ~ - h6 (DIN VDE 0623, EN 60309-2) with differential protection 4P 0.03A 400V IEC 61008-1 / 1 x 32A EEC output - 3P + N + T - IP67 - 400V ~ - h6 (DIN VDE 0623, EN 60309-2) / 1 x MCB 32A 4P (3P + N) 400V ~ / 6 x 16A EEC outputs - 2P + T - IP67 - 230V ~ - h6 (DIN VDE 0623, EN 60309-2) all with dedicated 16A MCB 2P (1P + N). All outputs are protected from differential 4P 0.03A 415V ~. All controls are located under in plastic covers providing IP67 protection. Maximum load 63A.



• Stacking equipments example.

POWER DISTRIBUTION BOXES "ELBOX" SERIES

ELECTRIC DISTRIBUTION



ELBOX5563AP **NEW**



- Power box portatile IP55 in materiale plastico antiurto. Dotato di: ingresso con spina diretta CEE 63A - 3P+N+T - IP67 - 400V ~ - h6 (DIN VDE 0623, EN 60309-2)/n° 2 interruttori magnetotermici 32A 4P (3P+N) 400V ~/n. 6 uscite su prese CEE 16A - 2P+T - IP44 - 230V ~ - h6 (DIN VDE 0623, EN 60309-2) + n. 3 uscite su prese Schuko 16A - 2P+T - IP54 - 230V ~ (DIN 49440-1) tutte con interruttore magnetotermico differenziale 16A 2P(1P+N) dedicato. Dotato di pulsante di emergenza a fungo illuminato e di una presa con connettore NAC3FPXTOP per comando di emergenza remoto. Tutti i comandi sono posizionati sotto sportelli in materiale plastico con protezione IP67. Portata massima 63A.
- Portable IP55 Power Box in an impact resistant plastic structure. Featuring: Straight input connector CEE 63A - 3P + N + T - IP67 - 400V ~ - h6 (DIN VDE 0623, EN 60309-2) with MCB 63A 4P 0.03A 400V + shunt release ~ IEC61008-1 / 2 x 32A EEC socket outputs - 3P + N + T - IP67 - 400V ~ - h6 (DIN VDE 0623, EN 60309-2) / 2 x RCBO 32A 4P (3P + N) 400V ~ / 6 x 16A EEC outputs - 2P + T - IP44 - 230V ~ - h6 (DIN VDE 0623, EN 60309-2) + 3 x Schuko outputs 16A - 2P + T - IP54 - 230V ~ (DIN 49440-1) all with dedicated RCBO 16A 2P (1P + N). Featuring an illuminated emergency switch and a NAC3FPXTOP socket for remote emergency switch connection. All controls are located under in plastic covers providing IP67 protection. Maximum load 63A.



ELBOX55125AP **NEW**



- Power box portatile IP55 in materiale plastico antiurto. Dotato di: ingresso con spina diretta CEE 125A - 3P+N+T - IP67 - 400V ~ - h6 (DIN VDE 0623, EN 60309-2) con protezione differenziale 4P 0.03A 400V ~ IEC61008-1/n. 2 uscite su prese CEE 63A - 3P+N+T - IP67 - 400V ~ - h6 (DIN VDE 0623, EN 60309-2)/n° 2 interruttori magnetotermici 63A 4P (3P+N) 400V ~/n. 2 uscite su prese CEE 32A - 3P+N+T - IP67 - 400V ~ - h6 (DIN VDE 0623, EN 60309-2)/n° 2 interruttori magnetotermici 32A 4P (3P+N) 400V ~/n. 6 uscite su prese CEE 16A - 2P+T - IP44 - 230V ~ - h6 (DIN VDE 0623, EN 60309-2) tutte con interruttore magnetotermico differenziale 16A 2P(1P+N) dedicato. Dotato di pulsante di emergenza a fungo illuminato e di una presa con connettore NAC3FPXTOP per comando di emergenza remoto. Tutti i comandi sono posizionati sotto sportelli in materiale plastico con protezione IP67. Portata massima 63A.
- Portable IP55 Power Box in an impact resistant plastic structure. Featuring: Straight input connector CEE 125A - 3P + N + T - IP67 - 400V ~ - h6 (DIN VDE 0623, EN 60309-2) with MCB 125A 4P 0.03A 400V + shunt release ~ IEC61008-1 / 2 x 63A EEC socket outputs - 3P + N + T - IP67 - 400V ~ - h6 (DIN VDE 0623, EN 60309-2) / 2 x RCBO 63A 4P (3P + N) 400V ~ / 2 x 32A EEC socket outputs - 3P + N + T - IP67 - 400V ~ - h6 (DIN VDE 0623, EN 60309-2) / 2 x RCBO 32A 4P (3P + N) 400V ~ / 6 x 16A EEC outputs - 2P + T - IP44 - 230V ~ - h6 (DIN VDE 0623, EN 60309-2) all with dedicated RCBO 16A 2P (1P + N). Featuring an illuminated emergency switch and a NAC3FPXTOP socket for remote emergency switch connection. All controls are located under in plastic covers providing IP67 protection. Maximum load 63A.

ELBOXRES **NEW**



- Sistema di comando di emergenza a distanza realizzato con scatola in gomma dotata di interruttore di emergenza a fungo, con cavo HPC3015FG - 3 x 1,5 mm² - di lunghezza 10 metri e connettore NAC3MXWTOP.
- Remote emergency control system made with rubber box equipped with emergency switch, connected with HPC3015FG - 3 x 1,5 mm² - cable 10 meters long and NAC3MXWTOP connector.



PORTABLE POWER BOX COMPACT POWER DISTRIBUTION MODULES "SDC" SERIES

ELECTRIC DISTRIBUTION



SDC350

- Pratico e compatto power box portatile, realizzato con struttura in gomma con maniglia di trasporto integrata. Dotato di cavo di alimentazione HPC5006FG - 5 x 6 mm²/10 m, con spina volante CEE 32A - 3P+N+T - 400V~ (DIN VDE 0623, EN 60309-2). Equipaggiato con n. 6 uscite Schuko 16A - 2P+T - IP54 - 230V~ (DIN 49440-1). Ciascuna uscita ha un interruttore magnetotermico 2P/C16 dedicato e tutti i sei moduli sono posizionati sotto uno sportellino con grado di protezione IP67.
- Compact portable power distribution box made by solid rubber with integrated carrying handle. Features: entry with 10m HPC5006FG (5 x 6mm²) power cable with 32A - 3P+N+G - 400V~ - h6 plug (DIN VDE 0623, EN 60309-2). Outlet: n. 6 x 16A - 2P+G - IP54 - 230V~ Schuko socket (DIN 49440-1). Each socket has a dedicated 2P/C16 circuit breaker switch under a 6 modules IP67 window.

SDC360

- Pratico e compatto power box portatile, realizzato con struttura in gomma con maniglia di trasporto integrata e con le stesse caratteristiche del modello SDC350, ma con n. 6 uscite CEE 16A - 2P+T - IP44 - 230V~ - h6 (DIN VDE 0623, EN 60309-2).
- Compact portable power distribution box made by solid rubber with same features of SDC350, but with n. 6 x 16A - 2P+G - IP44 - 230V~ CEE - h6 socket (DIN VDE 0623, EN 60309-2).

SDC3232

- Modulo 3U rack 19" cablato per distribuzione elettrica. Il modulo è dotato, nella parte anteriore, di ingresso con n. 1 spina CEE 32A - 3P+N+T - 400V~ - h6 (DIN VDE 0623, EN 60309-2), n. 1 presa per rilancio CEE 32A - 3P+N+T - 400V~ - h6 (DIN VDE 0623, EN 60309-2) e n. 1 uscita diretta su presa Schuko 16A - 2P+T - IP54 - 230V~ (DIN 49440-1). Nella parte posteriore sono posizionate n. 6 prese Schuko 16A - 2P+T - IP54 - 230V~ (DIN 49440-1), comandate da n. 3 interruttori magnetotermici 2P/C16, ciascuno a protezione di n° 2 prese (interruttori posizionati nella parte frontale).
- 19" rack 3U wired compact power distribution module featuring: front side: 1 x 32A - 3P+N+G plug (IP44 - 400V~ - h6), 1 x 32A 3P+N+G socket (IP44 - 400V~ - h6), 1 x direct 16A - 2P+G Schuko socket (IP54 - 230V~ - DIN 49440-1) / Back side: n. 6 x 16A - 2P+G - Schuko socket (IP54 - 230V~ - DIN 49440-1) with n. 3 x 2P/C16 circuit breaker switch control (placed on the front side).

| TECH INFO | SDC350 | SDC360 | SDC3232 |
|-----------------|--|--|--|
| Input: | - 10m HPC5006FG (5 x 6mm ²) cable with 32A 3P+N+G - IP44 - 400V~ - h6 - CEE plug (DIN VDE 0623, EN 60309-2) | - 10m HPC5006FG (5 x 6mm ²) cable with 32A - 3P+N+G - IP44 - 400V~ - h6 - CEE plug (DIN VDE 0623, EN 60309-2) | - n. 1 x 32A - 3P+N+G - IP44 - 400V~ - h6 - CEE panel mount plug. |
| Outputs: | - n. 6 x 16A 2P+G - IP54 - 230V~ Schuko socket (DIN 49440-1). Each socket has a dedicated 2P/C16 circuit breaker switch under a 6 modules IP67 window. | - n. 6 x 16A - 2P+G - IP44 - 230V~ CEE socket (DIN VDE 0623, EN 60309-2). Each socket has a dedicated 2P/C16 circuit breaker switch under a 6 modules IP67 window. | - n. 1 x 32A - 3P+N+G - IP44 - 400V~ - h6 - CEE panel mount plug. - n. 1 x direct 16A - 2P+G - IP54 - 230V~ Schuko socket (DIN 49440-1) on the front side. - N. 6 x 16A - 2P+G - IP54 - 230V~ Schuko socket (DIN 49440-1) on the back side, with n. 3 x 2P/C16 circuit breaker switch (placed on the front side) |

19" RACK DISTRIBUTION MODULES "SDC" SERIES

ELECTRIC DISTRIBUTION



SDC130 - SDC130BK

SDC130 - SDC130BK

- Modulo di uscita 2U rack 19" cablato, dotato di n. 6 prese CEE 16A - 2P+T - IP44 - 230V~ - h6 (DIN VDE 0623, EN 60309-2). Disponibile nelle versioni: SDC130 con prese di colore BLUE/SDC130BK con prese di colore NERO. Confezione: 1 pezzo.
- 2U wired 19" rack module, n. 6 x 16A - 2P+G - socket (IP44 - 230V~ - CEE - h6 - DIN VDE 0623, EN 60309-2) / SDC130BK features BLACK colour sockets. Master pack: 1 pc.



rear view for all SDC400 models



SDC460

SDC465

SDC470

SDC460

- Modulo di distribuzione 2U rack 19" cablato, dotato di n. 1 spina da pannello diretta CEE 16A - 2P+T - IP67 - 230V~ - h6 (DIN VDE 0623, EN 60309-2) e n. 6 prese da pannello Schuko 16A - 2P+T - IP54 - 230V~ (DIN 49440-1). Confezione: 1 pezzo.
- 2U assembled 19" rack module with n 1 x 16A - 2P+G - plug (IP67 - 230V~ - CEE - h6 - DIN VDE 0623, EN 60309-2) and n.6 x 16A - 2P+G - IP54 - 230V~ Schuko socket (DIN 49440-1). Master pack: 1 pc.



SDC465

- Modulo di distribuzione 2U rack 19" cablato, dotato di n. 1 spina da pannello diretta CEE 32A - 2P+T - IP67 - 230V~ - h6 (DIN VDE 0623, EN 60309-2) e n. 6 prese da pannello Schuko 16A - 2P+T - IP54 - 230V~ (DIN 49440-1). Confezione: 1 pezzo.
- 2U assembled 19" rack module with n 1 x 32A - 2P+G - plug (IP67 - 230V~ - CEE - h6 - DIN VDE 0623, EN 60309-2) and n.6 x 16A - 2P+G - IP54 - 230V~ Schuko socket (DIN 49440-1). N.B. Needs 1 unit free space below for assembling. Master pack: 1 pc.



SDC470

- Modulo di distribuzione 2U rack 19" cablato, dotato di n. 1 spina da pannello diretta CEE 32A - 3P+N+T - IP67 - 400V~ - h6 (DIN VDE 0623, EN 60309-2) e n. 6 prese da pannello Schuko 16A - 2P+T - IP54 - 230V~ (DIN 49440-1). Confezione: 1 pezzo.
- 2U assembled 19" rack module with n 1 x 32A - 3P+N+G - plug (IP67 - 400V~ - CEE - h6 - DIN VDE 0623, EN 60309-2) and n.6 x 16A - 2P+G - IP54 - 230V~ Schuko socket (DIN 49440-1). N.B. Needs 1 unit free space below for assembling. Master pack: 1 pc.



FEEDING MOBILE SYSTEMS "SDC300" SERIES



SDC308R

- Barra di alimentazione realizzata in profilato di alluminio e materiali plastici, non propaganti l'incendio. Dotata di 8 prese Schucko 16^o - 2P+T - 230V con interruttore luminoso di colore rosso, cavo di lunghezza 2.5 m con sezione 3x1.5 mm² e spina Schuko 16A 2P + T - 230V (CE 73/23). Portata max: 3500W. Dotata di alette in metallo universali, per il montaggio su armadi rack 19". Confezione: 1 pezzo. Disponibile nel colore nero.
- 1U horizontal feeding bar made of aluminium profile and flame retardant thermoplastic parts. Features n.8 x 16A 230V 2P +G. Schuko outlet with red lighting switch; 2.5 m length 3 x 1.5 mm² power cable and 16A 2P + G Schuko plug (230V, CE 73/23). Max capacity: 3500W. Equipped with universal metal fins, for mounting on 19" rack cabinets. Master pack: 1 pc.



PROFESSIONAL ELECTRIC EXTENSIONS "SM" - "SDC700" SERIES

ELECTRIC DISTRIBUTION

SM200

- Cavo di alimentazione assemblato PROEL (3x1 mm²) con connessioni presa volante EC standard 3 poli -> spina volante EC standard 3 poli. Disponibile in nero. Confezione: 1 pezzo.
- PROEL assembled Power cable (3 x 1 mm²) with EC standard 3P cable mount female socket > EC standard 3P cable mount male plug connections. Available in Black. Master pack: 1 pc.

| CODE | LENGTH |
|-----------|------------------|
| SM200LU25 | 2,5 mt (8.20 ft) |

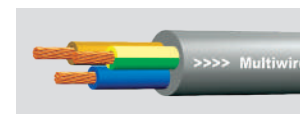

SM300

- Cavo di alimentazione assemblato PROEL (3x1 mm²) con connessioni presa volante EC standard 3 poli -> spina volante SCHUKO 16A. Disponibile in nero. Confezione: 1 pezzo.
- PROEL assembled Power cable (3 x 1 mm²) with EC standard 3P cable mount female socket > Schuko 16A standard 3P cable mount male plug connections. Available in Black. Master pack: 1 pc.

| CODE | LENGTH |
|-----------|------------------|
| SM300LU25 | 2,5 mt (7.62 ft) |
| SM300LU5 | 5 mt (16.40 ft) |
| SM300LU10 | 10 mt (32.81 ft) |
| SM300LU15 | 15 mt (49.21 ft) |

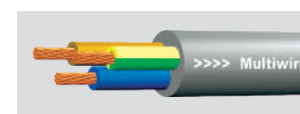

SDC775



- Prolunga elettrica Professionale PROEL con cavo HPC3025FG "flame retardant" 3x2.5 mm², assemblata con n. 1 presa volante Neutrik "Powercon" di potenza 20A, grigio, "POWER OUT" system, 3P e 1 presa volante Neutrik "Powercon" di potenza 20A, blue, "POWER IN" system, 3P. Disponibile in nero. Confezione: 1 pezzo.
- PROEL Professional Electric extension with HPC3025FG - 3 x 2.5 mm² fire retardant power cable with n. 1 x Neutrik "Powercon" 20A cable mount female socket, grey, "POWER OUT" system, 3P > n. 1 x Neutrik "powercon" 20A cable mount female socket, blue, "POWER IN" system, 3P. Available in Black. Master pack: 1 pc.

| CODE | LENGTH |
|-------------|------------------|
| SDC775LU007 | 0,7 mt (2.29 ft) |
| SDC775LU015 | 1,5 mt (4.92 ft) |
| SDC775LU025 | 2,5 mt (7.62 ft) |
| SDC775LU05 | 5 mt (16.40 ft) |
| SDC775LU10 | 10 mt (32.81 ft) |



HPC3025FG

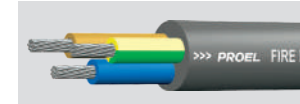

SDC780



- Prolunga elettrica Professionale PROEL con cavo HPC3025FG "flame retardant" 3x2.5 mm², assemblata con n. 1 spina Schuko 16A - 2P+T - IP44 - 230V~ (DIN 49440) e n. 1 presa volante Neutrik "Powercon" di potenza 20A, blue, "POWER IN" system, 3P. Disponibile in nero. Confezione: 1 pezzo.
- PROEL Professional Electric extension with HPC3025FG - 3 x 2.5 mm² fire retardant power cable with n. 1 x 16A - 2P+G - 230V~ - IP44 - Schuko plug > n. 1 x Neutrik "powercon" 20A cable mount female socket, blue, "POWER IN" system, 3P. Available in Black. Master pack: 1 pc.

| CODE | LENGTH |
|-------------|------------------|
| SDC780LU015 | 1,5 mt (4.92 ft) |
| SDC780LU025 | 2,5 mt (7.62 ft) |
| SDC780LU05 | 5 mt (16.40 ft) |
| SDC780LU10 | 10 mt (32.81 ft) |



HPC3025FG

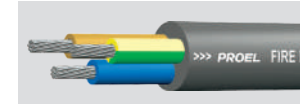

SDC785



- Prolunga elettrica Professionale PROEL con cavo HPC3025FG "flame retardant" 3x2.5 mm², assemblata con n. 1 presa volante Neutrik "powerCON TRUE1" di potenza 20A, "POWER OUT" system, 3P e 1 presa volante Neutrik "powerCON TRUE1" di potenza 20A, "POWER IN" system, 3P. Disponibile in nero. Confezione: 1 pezzo.
- PROEL Professional Electric extension with HPC3025FG - 3 x 2.5 mm² fire retardant power cable with n. 1 x Neutrik "powerCON TRUE1" 20A cable mount female socket, "POWER OUT" system, 3P > n. 1 x Neutrik "powerCON TRUE1" 20A cable mount female socket, "POWER IN" system, 3P. Available in Black. Master pack: 1 pc.

| CODE | LENGTH |
|-------------|------------------|
| SDC785LU015 | 1,5 mt (4.92 ft) |
| SDC785LU025 | 2,5 mt (7.62 ft) |
| SDC785LU05 | 5 mt (16.40 ft) |
| SDC785LU10 | 10 mt (32.81 ft) |



HPC3025FG

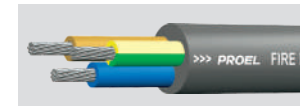

PROFESSIONAL ELECTRIC EXTENSIONS "SDC700" SERIES

ELECTRIC DISTRIBUTION

SDC790



• Prolunga elettrica Professionale PROEL con cavo HPC3025FG "flame retardant" 3x2.5 mm², assemblata con n. 1 spina Schuko 16A - 2P+T - IP44 - 230V~ (DIN 49440) e n. 1 presa volante Neutrik "powerCON TRUE1" di potenza 20A, "POWER IN" system, 3P. Disponibile in nero: Confezione: 1 pezzo.
 • PROEL Professional Electric extension with HPC3025FG - 3 x 2.5 mm² fire retardant power cable with n. 1 x 16A - 2P+G - 230V~ - IP44 - Schuko plug > n. 1 x Neutrik "powerCON TRUE1" 20A cable mount female socket, "POWER IN" system, 3P. Available in Black. Master pack: 1 pc.

| CODE | LENGTH |
|-------------|------------------|
| SDC790LU015 | 1,5 mt (4.92 ft) |
| SDC790LU025 | 2,5 mt (7.62 ft) |
| SDC790LU05 | 5 mt (16.40 ft) |
| SDC790LU10 | 10 mt (32.81 ft) |



HPC3025FG

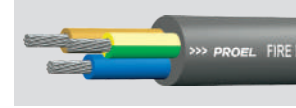

SDC795



• Prolunga elettrica Professionale PROEL con cavo HPC3025FG "flame retardant" 3x2.5 mm², assemblata con n. 1 spina CEE 16A - 2P+T - IP44 - 230V~ - h6(DIN VDE 0623, EN 60309-2) e 1 presa volante Neutrik "powerCON TRUE1" di potenza 20A, "POWER IN" system, 3P. Disponibile in nero: Confezione: 1 pezzo.
 • PROEL Professional Electric extension with HPC3025FG - 3 x 2.5 mm² fire retardant power cable with N. 1 x 16A - 2P+G - 230V - IP44 - h6 plug (DIN VDE 0623, EN 60309-2) > n. 1 x Neutrik "powerCON TRUE1" 20A cable mount female socket, "POWER IN" system, 3P. Available in Black. Master pack: 1 pc.

| CODE | LENGTH |
|-------------|------------------|
| SDC795LU015 | 1,5 mt (4.92 ft) |
| SDC795LU025 | 2,5 mt (7.62 ft) |
| SDC795LU05 | 5 mt (16.40 ft) |
| SDC795LU10 | 10 mt (32.81 ft) |



HPC3025FG

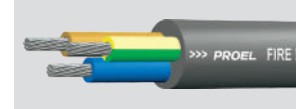

POWER CABLES "CVSOX" SERIES

ELECTRIC DISTRIBUTION

CVSOX



- Cavo di alimentazione Professionale multipolare PROEL. Realizzato con cavo di potenza HPC1925FGN "flame retardant" 19x2.5 mm², assemblato con n. 1 connettore femmina volante CSOX19FV SYNTAX - 19P e con n. 1 connettore maschio volante CSOX19MV SYNTAX - 19P. Disponibile in colore NERO.
- PROEL professional multicore power cable. Consists of PROEL HPC1925FGN - 19 x 2.5 mm² flame resistant power cable assembled with n. 1 x SYNTAX CSOX19FV Multipin cable mount power connector (19P female) > n. 1 x SYNTAX CSOX19MV Multipin cable mount power connector (19P male). Available in Black.

| CODE | LENGTH |
|---------|-------------------|
| CVSOX05 | 5 mt (16.40 ft) |
| CVSOX10 | 10 mt (32.80 ft) |
| CVSOX15 | 15 mt (49.21 ft) |
| CVSOX20 | 20 mt (65.62 ft) |
| CVSOX25 | 25 mt (82.02 ft) |
| CVSOX30 | 30 mt (98.43 ft) |
| CVSOX40 | 40 mt (131.23 ft) |



HPC1925FGN

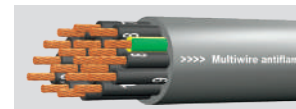

CVS0601F



- Cavo di alimentazione multipolare professionale PROEL, composto da 6 cavi di alimentazione antifiama PROEL HPC3025FG - 3 x 2,5 mm² - assemblati con 1 connettore di alimentazione "spider" CSOX19MVSP SYNTAX (19P maschio) e n° 6 x presa CEE 16A - 2P+T - IP44 - 230V ~ - h6(DIN VDE 0623, EN 60309-2).
- PROEL professional multicore power cable. Consists of 6 x PROEL HPC3025FG - 3 x 2.5 mm² flame resistant power cable assembled with n° 1 x SYNTAX CSOX19MVSP "spider" multipin cable mount power connector (19P male) > n° 6 x 16A - 2P+G - 230V - IP44 - h6 socket (DIN VDE 0623, EN 60309-2).

| CODE | LENGTH |
|----------|----------------|
| CVS0601F | 1 mt (3.28 ft) |



HPC3025FG

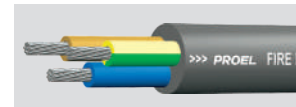

CVS0601M



- Cavo di alimentazione multipolare professionale PROEL, composto da 6 cavi di alimentazione antifiama PROEL HPC3025FG - 3 x 2,5 mm² - assemblati con 1 connettore di alimentazione "spider" CSOX19FVSP SYNTAX (19P femmina) e n° 6 x spina CEE 16A - 2P+T - IP44 - 230V ~ - h6(DIN VDE 0623, EN 60309-2).
- PROEL professional multicore power cable. Consists of 6 x PROEL HPC3025FG - 3 x 2.5 mm² flame resistant power cable assembled with n° 1 x SYNTAX CSOX19FVSP "spider" multipin cable mount power connector (19P female) > n° 6 x 16A - 2P+G - 230V - IP44 - h6 plug (DIN VDE 0623, EN 60309-2).

| CODE | LENGTH |
|----------|----------------|
| CVS0601M | 1 mt (3.28 ft) |



HPC3025FG

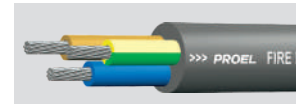

• Custom lengths are available on request

I.E.C. REGULATIONS COMPLIANT PLUGS & SOCKETS "SDC" SERIES

ELECTRIC DISTRIBUTION

SDC852BK

- Spina volante 16A - 2P+T - 230V~ - IP44 - h6 (CE 73/23) di colore NERO.
- Confezione: 1 pezzo.
- Black 16A - 2P+G - 230V - h6 - IP44 cable mount plug (CE 73/23).
- Master pack: 1 pc.



SDC853

- Spina volante 32A - 2P+T - 230V~ - IP44 - h6 (CE 73/23) di colore BLUE.
- Confezione: 1 pezzo.
- 32A - 2P+G - 230V - h6 - IP44 cable mount plug (CE 73/23). Master pack: 1 pc.



SDC843BK

- Presa volante 16A - 2P+T - 230V~ - IP44 - h6 (CE 73/23) di colore NERO.
- Confezione: 1 pezzo.
- Black 16A - 2P+G - 230V - h6 - IP44 cable mount socket (CE 73/23).
- Master pack: 1 pc.



SDC844

- Presa volante 32A - 2P+T - 230V~ - IP44 - h6 (CE 73/23) di colore BLUE.
- Confezione: 1 pezzo.
- 32A - 2P+G - 230V - h6 - IP44 cable mount socket (CE 73/23). Master pack: 1 pc.



SDC2PV

- Presa volante 32A - 3P+N+T - 400V~ - IP44 - h6 (CE 73/23) di colore ROSSO.
- Confezione: 1 pezzo.
- 32A - 3P+N+G - 400V - h6 - IP44 cable mount socket (CE 73/23).
- Master pack: 1 pc.



SDC840

- Presa da pannello diritta a flangia ridotta 16A - 2P+T - 230V~ - IP44 - h6 (CE 73/23) di colore GRIGIO/BLUE.
- Confezione: 1 pezzo.
- 16A - 2P+G - 230V - h6 - IP44 panel mount socket (CE 73/23). Master pack: 1 pc.



SDC840BK

- Presa da pannello diritta a flangia ridotta 16A - 2P+T - 230V~ - IP44 - h6 (CE 73/23) di colore NERO.
- Confezione: 1 pezzo.
- Black 16A - 2P+G - 230V - h6 - IP44 panel mount socket (CE 73/23).
- Master pack: 1 pc.



SDC863GS

- Presa volante Schuko 16A - 2P+T - 230V~ - IP44 con coperchio di protezione (DIN 49440). Corpo in gomma e frutto in tecnopolimero ad alta resistenza al calore, agli urti e agli olii.
- Confezione: 1 pezzo.
- 16A - 2P+G - 230V - IP44 - cable mount Schuko socket with protective cap (DIN 49440). Rubber external body and engineering polymer inner body, highly resistant to heat, shock and oils.
- Master pack: 1 pc.



SDC864GS

- Spina volante Schuko 16A - 2P+T - 230V~ - IP44 (DIN 49440). Corpo in gomma e frutto in tecnopolimero ad alta resistenza al calore, agli urti e agli olii.
- Confezione: 1 pezzo.
- 16A - 2P+G - 230V - IP44 - cable mount Schuko plug (DIN 49440). Rubber external body and engineering polymer inner body, highly resistant to heat, shock and oils.
- Master pack: 1 pc.



POWER CONNECTOR

ELECTRIC DISTRIBUTION

NAC3FCA

- Presa volante NEUTRIK "POWERCON" di potenza 20A, blue, "POWER IN" system, 3 poli.
- Neutrik "Powercon" cable mount 20A female power socket, blue, "POWER IN" system, 3 poles.



NAC3FCB

- Presa volante NEUTRIK "POWERCON" di potenza 20A, grigio, "POWER OUT" system, 3 poli.
- Neutrik "Powercon" cable mount 20A female power socket, grey, "POWER OUT" system, 3 poles.



NAC3MPA

- Spina da pannello NEUTRIK "powercon" di potenza 20A, blue, "POWER IN" system, 3 poli.
- Neutrik "Powercon" panel mount 20A male power receptacle, blue, "POWER IN" system, 3 poles.



NAC3MPB

- Spina da pannello NEUTRIK "powercon" di potenza 20A, grigio, "POWER OUT" system, 3 poli.
- Neutrik "Powercon" panel mount 20A male power receptacle, grey, "POWER OUT" system, 3 poles.



NB: vedere pagina 171 per connettori true1 • NB: see page 171 for true1 connectors

MULTIPIN POWER CONNECTORS "CSOX" SERIES



CSOX19MV



CSOX19FV

CSOX19MV

- Connettore di potenza multipolare SYNTAX, maschio volante 19P con serracavo PG29. Sistema di accoppiamento a vite e compatibilità con connettori SOCAPEX. Confezione: 1 pezzo.
- SYNTAX cable mount aluminium Multipin power connector - male plug (19P) - Screw coupling system. SOCAPEX compatible. Master pack: 1 pc.



CSOX19FP

- Connettore di potenza multipolare SYNTAX, maschio volante 19P con serracavo PG29. Sistema di accoppiamento a vite e compatibilità con connettori SOCAPEX. Confezione: 1 pezzo.
- SYNTAX panel mount aluminium Multipin power connector - female socket (19P) - Screw coupling system. SOCAPEX compatible. Master pack: 1 pc.



IP67



CSOX19FP



CSOX19MP

CSOX19FV

- Connettore di potenza multipolare SYNTAX, femmina volante 19P con serracavo PG29. Sistema di accoppiamento a vite e compatibilità con connettori SOCAPEX. Confezione: 1 pezzo.
- SYNTAX cable mount aluminium Multipin power connector - female socket (19P) - Screw coupling system. SOCAPEX compatible. Master pack: 1 pc.



CSOX19MP

- Connettore di potenza multipolare SYNTAX, maschio da pannello 19P. Sistema di accoppiamento a vite e compatibilità con connettori SOCAPEX. Confezione: 1 pezzo.
- SYNTAX panel mount aluminium Multipin power connector - male plug (19P) - Screw coupling system. SOCAPEX compatible. Master pack: 1 pc.



FLIGHT CASES

• Il Flight Case è la più alta espressione tecnologica di contenitore, per resistenza ad urti violenti, praticità di trasporto ed utilizzo, eccezionale durata nel tempo e naturalmente un design elegante. L'accurata scelta dei materiali, tutti di primissima qualità, la tecnologia dei macchinari impiegati nella produzione, insieme alla cura che solo un assemblaggio manuale può garantire, consentono la massima affidabilità nell'uso ed il soddisfacimento di esigenze individuali attraverso la personalizzazione del prodotto. La riconosciuta competenza ed organizzazione della PROEL, nel delinearne una posizione di prestigio internazionale, ci consente di risolvere ogni problema, offrendo articoli costruiti "ad hoc" anche singolarmente, e con una celerità che non teme confronti (a richiesta è possibile personalizzare anche lo standard).

• *The Proel flight case is the highest expression in protection technology for resistance to shock and damage, ease of transport and use, durability against wear and tear, and attractive design. The choice of the highest quality materials and production technology are combined with the guarantee of quality assured by hand-assembly to give the maximum in reliability and the capability of customized products. The capacity and organization of PROEL is world renown for responding to every need with products constructed ad hoc, even single units, with incomparable swiftness (on request, even Standard Line cases can be customized).*



SECTOR INDEX

FLIGHT CASES



| SECTION | PAGE |
|---------|------|
|---------|------|

19" Rack Cases

| | |
|---|-----|
| 19" Standard Rack Cases - "BLKM" 120 Series | 219 |
| 19" Standard Rack Cases - "BLKM" 100 Series | 219 |
| 19" Professional Rack Cases - "BLKM" 150 Series | 220 |
| 19" Professional Rack Cases - "BLKM" 200 Series | 220 |
| 19" Professional "COMBO" Rack Cases - "BLKM" Series | 222 |

19" Rack Cases with wheels

| | |
|---|-----|
| 19" Professional Rack Cases with wheels - "BLKMW" 200 Series | 221 |
| 19" Professional Foam Suspended Rack Cases with wheels "BLKMW" 400 Series | 221 |
| 19" Professional "COMBO" Rack Cases with wheel - "BLKM" Series | 223 |

| | |
|---|-----|
| 19" Professional Rack Cases Accessories | 222 |
|---|-----|

| | |
|---------------------------------|-----|
| Microphone Cases - "BLK" Series | 223 |
|---------------------------------|-----|

Storage Cases

| | |
|--|-----|
| Microphone Stand Case - "Professional" Series | 224 |
| Professional Drawer Case - "SL" Series | 224 |
| Professional Storage Cases with wheels - "BLKW" Series | 225 |
| Multifunctional Cases - "BLK" Series | 225 |

DJ Cases & Accessories

| | |
|---|-----|
| DJ Cases - "Coffin" Series | 226 |
| DJ Cases - Professional Turntable Case | 226 |
| DJ Cases - "Professional Controller" Series | 227 |

| | |
|--------------------------|-----|
| Flight Cases Accessories | 228 |
|--------------------------|-----|

19" STANDARD RACK CASES "120BLKM" SERIES

FLIGHT CASES



CR122BLKM

25 CM RACKABLE DEPTH
FRONT SINGLE RACK RAILS

• Custodie rack 19" standard realizzate in multistrato di pino marino a 5 strati ad incollaggio fenolico, di spessore 8 mm. Rivestimento in laminato plastico NERO antigraffio. Interno verniciato NERO. Dotate di chiusure a farfalla in acciaio zincato, maniglie con ritorno a molla, angolari in acciaio zincato, profili in alluminio professionali e piedini industriali in gomma. Barra rack standard nella parte anteriore con dotazione di viti, rondelle e dadi ingabbiati. Coperchi asportabili provvisti di fasce in Velcro per il serraggio dei cavi. Profondità utile corpo 25 cm, particolarmente ideale per sistemi microfonici wireless.

• 19" standard rack cases, 5-ply phenolic bond marine plywood constructions, 8mm thickness. Black laminated water and scratch resistant covering. Black inner painted. Provided with small steel surface butterfly twist latches, surface handles (spring loaded), steel ball-corner, professional aluminium profile and industrial grade rubber feet. Standard rack rails in the front and numbers of install rack rail screws, washers, cage nuts are included. - 25 cm rackable depth ideal for wireless microphone equipment.

TECH INFO

| CODE | UNIT | WEIGHT |
|-----------|------|---------|
| CR122BLKM | 2U | 5.40 kg |
| CR123BLKM | 3U | 6.35 kg |
| CR124BLKM | 4U | 7.25 kg |
| CR126BLKM | 6U | 8.90 kg |

19" STANDARD RACK CASES "100BLKM" SERIES



33 CM RACKABLE DEPTH
FRONT SINGLE RACK RAILS

• Custodie rack 19" standard realizzate in multistrato di pino marino a 5 strati ad incollaggio fenolico, di spessore 8 mm. Rivestimento in laminato plastico NERO antigraffi o. Interno verniciato NERO. Dotate di chiusure a farfalla in acciaio zincato, maniglie con ritorno a molla, angolari in acciaio zincato, profili in alluminio professionali e piedini industriali in gomma. Barra rack standard nella parte anteriore con dotazione di viti, rondelle e dadi ingabbiati. Coperchi asportabili provvisti di fasce in Velcro per il serraggio dei cavi. Profondità utile corpo 33 cm.

• 19" standard rack cases, 5-ply phenolic-bond marine plywood constructions, 8Wmm thickness. Black laminated water and scratch-resistant covering. Black inner painted. Provided with small steel surface butterfly twist latches, surface handles (spring loaded), steel ball-corner, professional aluminium profile and industrial grade rubber feet. Standard rack rails in the front and numbers of install rack rail screws, washers, cage nuts are included. - 33 cm. rackable depth.

TECH INFO

| CODE | UNIT | WEIGHT |
|-----------|------|----------|
| CR102BLKM | 2U | 6.90 kg |
| CR103BLKM | 3U | 7.75 kg |
| CR104BLKM | 4U | 8.65 kg |
| CR105BLKM | 5U | 9.40 kg |
| CR106BLKM | 6U | 10.10 kg |
| CR108BLKM | 8U | 12.20 kg |

19" STANDARD RACK CASES "150BLKM" SERIES

FLIGHT CASES



CR154BLKM

• Serie di custodie rack professionali realizzate in multistrato di pino marino a 5 strati ad incollaggio fenolico, di spessore 7 mm. Rivestimento in laminato plastico NERO antigraffio. Interno verniciato NERO. Dotate di chiusure a farfalla ad incasso in acciaio zincato con predisposizione per lucchetto, maniglie ad incasso in acciaio zincato con impugnatura in gomma nera e ritorno a molla, angolari e rinforzi in acciaio zincato, profili in alluminio anodizzato e piedini industriali in gomma. Barra rack anteriore e posteriore con dotazione completa di viti, rondelle e dadi ingabbiati. Profondità utile corpo 25 cm, particolarmente ideale per sistemi microfonic wireless. Barre laterali di rinforzo in acciaio zincato. Coperchi rimovibili rivestiti in foam e provvisti di fasce in Velcro per la gestione dei cavi.

• 19" Professional rack cases, made by 5-Ply, phenolic-bond marine plywood, 7 mm thickness. Black laminated water and scratch-resistant covering. Black inner painted. Provided with recessed steel galvanized butterfly latches, recessed spring-loaded handles with rubber grip, steel ball-corner and stiffener, professional aluminium profile and industrial grade rubber feet. Front and rear rack rails and numbers of install rack rail screws, washers, cage nuts are included. 25 cm rackable depth ideal for wireless microphone equipment. Front and back lids with foam and mounted velcro straps for manage cables and accessories.

25 CM RACKABLE DEPTH
FRONT AND REAR SINGLE RACK RAILS
SUITABLE FOR WIRELESS MICROPHONES

TECH INFO

| CODE | UNIT | WEIGHT |
|-----------|------|---------|
| CR152BLKM | 2U | 6.40 kg |
| CR153BLKM | 3U | 7.25 kg |
| CR154BLKM | 4U | 8.05 kg |
| CR156BLKM | 6U | 9.10 kg |

19" STANDARD RACK CASES "200BLKM" SERIES



CR206BLKM

CR208BLKM



CR202BLKM



CR204BLKM

45 CM RACKABLE DEPTH
FRONT AND REAR DOUBLE RACK RAILS

• Custodie rack professionali realizzate in multistrato di pino marino a 5 strati ad incollaggio fenolico, di spessore 9 mm. Rivestimento in laminato plastico NERO antigraffi o. Interno verniciato NERO. Dotate di chiusure a farfalla ad incasso in acciaio zincato con predisposizione per lucchetto, maniglie ad incasso in acciaio zincato con impugnatura in gomma nera e ritorno a molla, angolari e rinforzi in acciaio zincato, profi li in alluminio anodizzato e piedini industriali in gomma. Barra rack doppia anteriore e posteriore con dotazione completa di viti, rondelle e dadi ingabbiati. Profondità utile corpo 45 cm. Coperchi rimovibili rivestiti in foam e provvisti di fasce in Velcro per il serraggio dei cavi.

• 19" Professional rack cases, made by 5-Ply, phenolic-bond marine plywood, 9 mm thickness. Black laminated water and scratch-resistant covering. Black inner painted. Provided with recessed steel galvanized butterfly latches, recessed spring-loaded handles with rubber grip, steel ball-corner and stiffener, professional aluminium profile and industrial grade rubber feet. Front and rear double rack rails and numbers of install rack rail screws, washers, cage nuts are included. 45 cm rackable depth. Front and back lids foamed eggs sheet foam and mounted velcro straps for manage cables and accessories.

TECH INFO

| CODE | UNIT | WEIGHT |
|-----------|------|----------|
| CR202BLKM | 2U | 8.50 kg |
| CR203BLKM | 3U | 9.95 kg |
| CR204BLKM | 4U | 11.30 kg |
| CR205BLKM | 5U | 12.00 kg |
| CR206BLKM | 6U | 12.80 kg |
| CR208BLKM | 8U | 16.50 kg |
| CR210BLKM | 10U | 20.50 kg |

19" PRO STANDARD RACK CASES WITH WHEELS "200BLKMW" SERIES FLIGHT CASES



45 CM RACKABLE DEPTH
FRONT AND REAR DOUBLE RACK RAILS
100 MM BLUE INDUSTRIAL WHEELS

• Custodie rack professionali 19" con ruote girevoli da 100 mm di tipo industriale (2 con freno). Realizzate in multistrato di pino marino a 5 strati ad incollaggio fenolico, di spessore 9 mm. Rivestimento in laminato plastico NERO antigraffio. Interno verniciato NERO. Dotate di chiusure a farfalla ad incasso in acciaio zincato con predisposizione per lucchetto, maniglie ad incasso in acciaio zincato con impugnatura in gomma nera e ritorno a molla, angolari e rinforzi in acciaio zincato, profili in alluminio anodizzato e piedini industriali in gomma. Barra rack doppia anteriore e posteriore con dotazione completa di viti, rondelle e dadi ingabbiati. Profondità utile corpo 45 cm. Barre laterali di rinforzo in acciaio zincato. Coperchi rimovibili rivestiti in foam e provvisti di fasce in Velcro per il serraggio dei cavi.

• 19" Professional rack cases with 100 mm blue industrial style wheels (two with brakes). Made by 5-Ply, phenolic-bond marine plywood, 9mm thickness. Black laminated water and scratch-resistant covering. Black inner painted. Provided with recessed steel galvanized butterfly latches, recessed spring-loaded handles with rubber grip, steel ball-corner and 6 holes brace, professional aluminium profile and industrial grade rubber feet. Front and rear double rack rails and numbers of install rack rail screws, washers, cage nuts are included. 45 cm rackable depth. Galvanized steel reinforced side bars. Front and back lids foamed eggs sheet foam and mounted velcro straps for manage cables and accessories.

CR216BLKMW



TECH INFO

| CODE | UNIT | WEIGHT |
|------------|------|----------|
| CR210BLKMW | 10U | 27.00 kg |
| CR212BLKMW | 12U | 30.50 kg |
| CR216BLKMW | 16U | 34.00 kg |
| CR218BLKMW | 18U | 36.00 kg |
| CR224BLKMW | 24U | 39.00 kg |

19" PRO FOAM SUSPENDED RACK CASES WITH WHEELS "400BLKMW" SERIES



50 CM RACKABLE DEPTH
FRONT AND REAR DOUBLE RACK RAILS
100 MM BLUE INDUSTRIAL WHEELS

• Custodie rack professionali 19" con telaio interno ammortizzato in foam per prevenire urti e cadute accidentali. Realizzate in multistrato di pino marino a 5 strati ad incollaggio fenolico, di spessore 9 mm. Rivestimento in laminato plastico NERO antigraffio. Interno verniciato NERO. Dotate di chiusure a farfalla ad incasso in acciaio zincato con predisposizione per lucchetto, maniglie ad incasso in acciaio zincato con impugnatura in gomma nera e ritorno a molla, angolari e rinforzi in acciaio zincato, profili in alluminio anodizzato e piedini industriali in gomma. Barra rack doppia anteriore e posteriore con dotazione completa di viti, rondelle e dadi ingabbiati. Profondità utile corpo 50 cm. Barre laterali di rinforzo in acciaio zincato. Coperchi rimovibili rivestiti in foam e provvisti di fasce in Velcro per il serraggio dei cavi. Ruote girevoli da 100 mm di tipo industriale (2 con freno).

• 19" Professional "FOAM SUSPENDED" rack cases have an added protection against blows and falls. Made by 5-Ply, phenolic-bond marine plywood, 9 mm thickness. Black laminated water and scratch-resistant covering. Black inner painted. Provided with recessed steel galvanized butterfly latches, recessed spring-loaded handles with rubber grip, steel ball-corner and stiffener, professional aluminium profile and industrial grade rubber feet. Front and rear double rack rails and numbers of install rack rail screws, washers, cage nuts are included. 50cm rackable depth. Galvanized steel reinforced side bars. Front and back lids foamed eggs sheet foam and mounted velcro straps for manage cables and accessories.. 100 mm blue industrial style wheels (two with brakes).

CR418BLKMW



CR412BLKMW



TECH INFO

| CODE | UNIT | WEIGHT |
|------------|------|----------|
| CR410BLKMW | 10U | 40.00 kg |
| CR412BLKMW | 12U | 43.00 kg |
| CR416BLKMW | 16U | 48.00 kg |
| CR418BLKMW | 18U | 50.70 kg |

19" PROFESSIONAL COMBO RACK CASES "SABLKM" SERIES

FLIGHT CASES

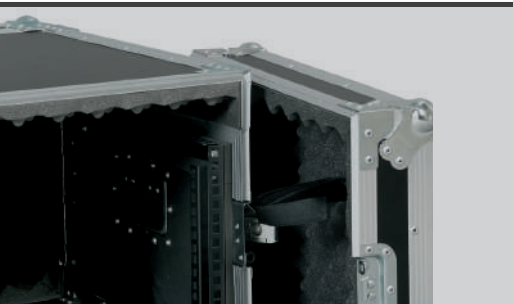

SA04BLKM



45 CM RACKABLE DEPTH
HEIGHT ADJUSTABLE 10U MIXER SPACE



SA08BLKM



SA06BLKM

• Custodie combo 19" con portamixer 10u regolabile in altezza realizzate in multistrato di pino marino a 5 strati ad incollaggio fenolico, di spessore 9 mm. Rivestimento in laminato plastico NERO antigraffio. Interno verniciato NERO. Dotate di chiusure a farfalla ad incasso in acciaio zincato con predisposizione per lucchetto, maniglie ad incasso in acciaio zincato con impugnatura in gomma nera e ritorno a molla, angolari e rinforzi in acciaio zincato, profili in alluminio anodizzato e piedini industriali in gomma. Barra rack doppia anteriore con dotazione completa di viti, rondelle e dadi ingabbiati. Profondità utile corpo 45 cm.

• 19" Professional "COMBO" rack cases with 10U height adjustable mixer space, made by 5-Ply, phenolic-bond marine plywood, 9 mm thickness. Black laminated water and scratch-resistant covering. Black inner painted. Provided with recessed steel galvanized butterfly latches, recessed spring-loaded handles with rubber grip, steel ball-corner and stiffener, professional aluminium profile and industrial grade rubber feet. Front double rack rail and numbers of install rack rail screws, washers, cage nuts are included. Front and back lids foamed eggs sheet foam and mounted velcro straps for manage cables and accessories. - 45 cm rackable depth.

TECH INFO

| CODE | UNIT | WEIGHT |
|----------|------|----------|
| SA04BLKM | 4U | 16.50 kg |
| SA06BLKM | 6U | 19.00 kg |
| SA08BLKM | 8U | 20.80 kg |
| SA10BLKM | 10U | 21.80 kg |

19" PROFESSIONAL RACK CASES ACCESSORIES



FCRB200 - FCRB400 - FCRBSA



• Coppia di sostegni ad "L" per flight cases a rack delle serie CR2xxBLKMW, CR4xxBLKMW ed SAxxBLKM. Particolarmente indicati per il posizionamento di apparecchiature a rack pesanti.

• Pair of "L"-shaped supports for rack flight cases of the CR2xxBLKMW, CR4xxBLKMW and SAxxBLKM series. Particularly suitable for positioning heavy rack equipment.

TECH INFO

| CODE | NOTE | SUITABLE FOR |
|---------|------|-------------------|
| FCRB200 | Pair | CR2xxBLKM / BLKMW |
| FCRB400 | Pair | CR4xxBLKMW |
| FCRBSA | Pair | SAxxBLKM |



19" PROFESSIONAL COMBO RACK CASES WITH WHEELS "SABLMK" SERIES

FLIGHT CASES



45 CM RACKABLE DEPTH
FRONT AND REAR DOUBLE RACK RAILS
100 MM BLUE INDUSTRIAL WHEELS

• Custodie combo 19" con portamixer 10u regolabile in altezza i realizzate in multistrato di pino marino a 5 strati ad incollaggio fenolico, di spessore 9 mm. rivestimento in laminato plastico nero antigraffio. interno verniciato nero. dotate di chiusure a farfalla ad incasso in acciaio zincato con predisposizione per lucchetto, maniglie ad incasso in acciaio zincato con impugnatura in gomma nera e ritorno a molla, angolari e rinforzi in acciaio zincato, profi li in alluminio anodizzato e piedini industriali in gomma. barra rack doppia anteriore e posteriore con dotazione completa di viti, rondelle e dadi ingabbiati. Profondità utile corpo 45 cm. Ruote girevoli da 100 mm di tipo industriale (2 con freno).

• 19" Professional "COMBO" rack cases with 10U height adjustable mixer space, made by 5-Ply, phenolic-bond marine plywood, 9 mm thickness. Black laminated water and scratch-resistant covering. Black inner painted. Provided with recessed steel galvanized butterfly latches, recessed spring-loaded handles with rubber grip, steel ball-corner and stiffener, professional aluminium profile and industrial grade rubber feet. Front and rear double rack rails and numbers of install rack rail screws, washers, cage nuts are included. Front and back lids foamed eggs sheet foam and mounted velcro straps for manage cables and accessories. 45 cm rackable depth. 100 mm blue industrial style wheels (two with brake).

TECH INFO

| CODE | UNIT | WEIGHT |
|----------|------|----------|
| SA12BLKM | 12U | 35.50 kg |
| SA16BLKM | 16U | 37.00 kg |
| SA18BLKM | 18U | 42.50 kg |
| SA20BLKM | 20U | 43.50 kg |

MICROPHONE CASES "SABLMK" SERIES



SA31BLKM



SA31BLKM



SA32BLKM



SA32BLKM

• Pratica custodia per microfoni, realizzata in multistrato di pino marino a 5 strati ad incollaggio fenolico, di spessore 5 mm. Rivestimento in laminato plastico NERO antigraffio. La custodia è imbottita internamente in morbido foam ed è provvista di un inserto in foam ad alta densità con la predisposizione per l'inserimento verticale dei microfoni. A lato dell'inserto c'è un pratico vano per riporre cavi ed accessori. Dotata di chiusura a farfalla piccola ad incasso in acciaio zincato, maniglie ad incasso in acciaio zincato con impugnatura in gomma grigia e ritorno a molla, angolari e rinforzi in acciaio zincato, profili in alluminio anodizzato e piedini industriali in gomma.

• Practical microphone cases, made by 5-Ply, phenolic-bond marine plywood, 5 mm thickness. Black laminated water and scratch-resistant covering, High density EVA foam lining and high density EVA foam in 50mm thickness drilled holes for microphone holding. Provided with a dedicated space for cables and accessories. Recessed small steel galvanized butterfly latches, recessed spring-loaded handles with rubber grip, steel ball-corner and stiffener, professional aluminium profile and industrial grade rubber feet.

TECH INFO

| CODE | NOTE | WEIGHT |
|----------|-------------------------|---------|
| SA31BLKM | CASE FOR 9 MICROPHONES | 5.00 kg |
| SA32BLKM | CASE FOR 12 MICROPHONES | 6.00 kg |

MICROPHONE STANDS CASE "SABLK" SERIES

FLIGHT CASES



SA26BLK



• Custodia Professionale per aste microfoniche realizzata in multistrato di pino marino a 5 strati ad incollaggio fenolico, di spessore 9 mm. Rivestimento in laminato plastico NERO antigraffio. Internamente è provvista di tubi protettivi singoli in PVC per contenere 16 aste microfoniche. Dotata di chiusure a farfalla grandi ad incasso in acciaio zincato, maniglie ad incasso in acciaio zincato con impugnatura in gomma nera e ritorno a molla, angolari e rinforzi in acciaio zincato, profili in alluminio anodizzato e piedini industriali in gomma. Provvista di ruote da 100 mm industriali di colore blue (2 con freno).

• Professional microphone stand case, made by 5-Ply, phenolic- bond marine plywood, 10 mm thickness. Black laminated water and scratch-resistant covering. Provided with individual protective PVC tubes for 16 stands. Provided with small recessed steel galvanized butterfly latches, recessed spring-loaded handles with rubber grip, steel ball-corner and stiffener, professional aluminium profile. 4 x Ø 100 mm blue industrial style wheels (two with brakes).

TECH INFO

| CODE | INNER DIMENSION | WEIGHT |
|---------|---------------------|----------|
| SA26BLK | 438 x 438 x 1020 mm | 38.00 kg |

PROFESSIONAL DRAWER CASE "SLDRW" SERIES



• Custodia professionale con 4 capienti cassetti, con guide scorrevoli in acciaio. I cassetti sono rivestiti internamente con foam ad alta densità. I tre cassetti in alto hanno le seguenti dimensioni interne 440*114*460 mm (L*A*P) mentre l'ultimo cassetto misura 440*216*460 mm (L*A*P). Realizzata in multistrato di pino marino a 5 strati ad incollaggio fenolico, di spessore 9mm. Rivestimento in laminato plastico NERO antigraffio. Dotata di chiusure a farfalla professionali ad incasso in acciaio zincato, maniglie ad incasso in acciaio zincato con impugnatura in gomma di colore GRIGIO e ritorno a molla, angolari e rinforzi in acciaio zincato e profili in alluminio anodizzato. Ruote industriali da 100 mm di colore blue (2 con freno) che vengono fornite smontate. Coperchio asportabile.

• Professional 4 drawer tool cases, with sliding rails. All the drawer are fully padded with high density foam. The top three drawers have the following internal dimension 440*114*460 mm (W*H*D) while the lowest is 440*216*460 mm (L*A*P). Manufactured by 5-Ply, phenolic- bond marine plywood, 9 mm thickness. Black laminated water and scratch-resistant covering. Provided with recessed steel galvanized butterfly latches, recessed spring-loaded handles with rubber grip, steel ball-corner and stiffener, professional aluminium profile. Provided with 4 x detachable Ø 100 mm blue industrial style wheels (two with brakes). Removable lid.

TECH INFO

| CODE | OUTER DIMENSIONS (W*H*D) | WEIGHT |
|---------|--------------------------|---------|
| SL04DRW | 546 x 914 x 609 mm | 49.9 kg |

STORAGE CASES "BLKW" SERIES

FLIGHT CASES



SL10BLKW



SL15BLKW



SL20BLKW



SL25BLKW

Ø 100 MM BLUE INDUSTRIAL STYLE WHEELS

- Serie di bauli professionali da trasporto, realizzati in in multistrato di pino marino a 5 strati ad incollaggio fenolico, di spessore 8 mm. Rivestimento in laminato plastico NERO antigraffio. Dotate di chiusure a farfalla professionali ad incasso in acciaio zincato, maniglie ad incasso in acciaio zincato con impugnatura in gomma di colore GRIGIO e ritorno a molla, angolari e rinforzi in acciaio zincato e profili in alluminio anodizzato. Tutti i modelli sono equipaggiati con ruote industriali da 100 mm di colore blue (2 con freno) che vengono fornite smontate.
- Professional series of storage cases, made by 5-Ply, phenolic- bond marine plywood, 8 mm thickness. Black laminated water and scratch-resistant covering. 10mm high density EVA foam lining. Stainless steel piano hinges and heavy duty recessed lid stays are included. Provided with recessed steel galvanized butterfly latches, recessed spring-loaded handles with rubber grip, steel ball-corner and stiffener, professional aluminium profile and industrial grade rubber feet. Full piece of caster board painted black - made of 18mm plywood. All the models are provided with 4 x detachable Ø 100 mm blue industrial style wheels (two with brakes).

| TECH INFO | W x D x H | W x D x H | |
|-----------|-------------------------|------------------------|----------|
| CODE | OUTER DIMENSIONS | INNER BASE DIMENSIONS | WEIGHT |
| SL10BLKW | 600 x 400 x 500/640 mm | 545 x 345 x 390/60 mm | 17.50 kg |
| SL15BLKW | 800 x 400 x 500/640 mm | 745 x 345 x 390/60 mm | 21.00 kg |
| SL20BLKW | 800 x 600 x 500/640 mm | 745 x 545 x 390/60 mm | 30.00 kg |
| SL25BLKW | 1200 x 400 x 500/640 mm | 1150 x 345 x 390/60 mm | 30.50 kg |

MULTIFUNCTIONAL CASE - "BLK" SERIES



- Custodia professionale multifunzione, realizzata in in multistrato di pino marino a 5 strati ad incollaggio fenolico, di spessore 5 mm. Rivestimento in laminato plastico NERO antigraffio. Interno della base verniciato nero e rivestito in foam ad alta densità. Coperchio rivestito internamente con morbido foam "egg style". All'interno della custodia sono presenti 5 differenti pannelli in foam pretagliato che può essere modificato a piacimento per contenere apparecchi delicati. Dotata di chiusure a farfalla piccole ad incasso in acciaio zincato, maniglie ad incasso in acciaio zincato con impugnatura in gomma grigia e ritorno a molla, angolari e rinforzi in acciaio zincato, profili in alluminio anodizzato e piedini industriali in gomma.
- Professional multifunctional case, made by 5-Ply, phenolic- bond marine plywood, 5 mm thickness. Black laminated water and scratch-resistant covering, Black foam inner padding and egg foam on the cover. Inner customisable precutted 50mm pluck foam inserts are included, for universal storage proposal. Recessed small steel galvanized butterfly latches, recessed spring-loaded handles with rubber grip, steel ball-corner and stiffener, professional aluminium profile and industrial grade rubber feet.

| TECH INFO | | |
|-----------|--------------------|---------|
| CODE | INNER DIMENSIONS | WEIGHT |
| SL05BLK | 450 x 350 x 220 mm | 7.00 kg |

DJ CASES "COFFIN" SERIES FLIGHT CASES



• Custodie professionali per n. 2 CD PLAYER e n. 1 DJ mixer, realizzate in multistrato di pino marino a 5 strati ad incollaggio fenolico, di spessore 8 mm. Rivestimento in laminato plastico NERO antigraffio. Rivestimento interno in foam ad alta densità con pannelli mobili per poter disporre a piacimento gli apparecchi. Dotata di chiusure a farfalla ad incasso in acciaio zincato con predisposizione per lucchetto, maniglie ad incasso in acciaio zincato con impugnatura in gomma di colore GRIGIO e ritorno a molla, angolari e rinforzi in acciaio zincato, profili in alluminio anodizzato e piedini industriali in gomma. Coperchio asportabile provvisto di rivestimento interno in foam. Dimensioni interne: SD73PRODJ = 795 x 345 x 115 mm./SD83PRODJ = 795 x 450 x 115 mm.

• Professional case for 2 x CD players and 1 Dj MIXER, made by 5-Ply, phenolic-bond marine plywood, 8 mm thickness. Black laminated water and scratch-resistant covering. Inner foam padding. Provided with recessed steel galvanized butterfly latches, recessed spring-loaded handles with rubber grip, steel ball-corner and stiffener, professional aluminium profile and industrial grade rubber feet.

TECH INFO

| CODE | INNER DIMENSIONS | WEIGHT |
|-----------|--------------------|---------|
| SD73PRODJ | 795 x 345 x 115 mm | 7.80 kg |

DJ CASES PROFESSIONAL TURNTABLE CASE



INNER FOAM PADDING
LOW PROFILE BASE

SD82PRODJ

• Custodia Professionale per giradischi, realizzata in multistrato di pino marino a 5 strati ad incollaggio fenolico, di spessore 8 mm. Rivestimento in laminato plastico NERO antigraffi o. Rivestimento interno in foam ad alta densità per contenere i modelli più diffusi di giradischi, tipo Technics SL 1210 MKII. Chiusure a farfalla ad incasso in acciaio zincato con predisposizione per lucchetto, maniglia ad incasso in acciaio zincato con impugnatura in gomma nera e ritorno a molla, angolari e rinforzi in acciaio zincato, profili in alluminio anodizzato e piedini industriali in gomma. Coperchio asportabile provvisto di rivestimento interno in foam e base dal basso profilo per utilizzare il giradischi al suo interno.

• Professional turntable case, made by 5-Ply, phenolic-bond marine plywood, 8 mm thickness. Black laminated water and scratch-resistant covering. Inner high density foam padding to fit most popular turntables (Technics SL1200 and similar). Provided with recessed steel galvanized butterfly latches, strap handle with rubber grip, steel ball-corner and stiffener, professional aluminium profile and industrial grade rubber feet. Detachable cover and low profile tray design for operating the gear without take it out of the case.

DJ CASES PROFESSIONAL "CONTROLLER" SERIES

FLIGHT CASES

DJCTRLC1S



DJCTRLC5XXL



DJCTRLC2M



DJCTRLC3L



DJCTRLC1S - DJCTRLC2M - DJCTRLC3L

• Custodie professionali per DJ adatte a contenere una vasta gamma di controller di piccole (DJCTRLC1S), medie (DJCTRLC2M) e grandi (DJCTRLC3L) dimensioni. Realizzata in multistrato di pino marino a 5 strati ad incollaggio fenolico dello spessore di 9 mm. Rivestimento interno in foam sagomato ad alta densità e provvisto di spessori aggiuntivi, sempre in foam, per essere adattato ad apparecchi di diversa dimensione. Provvisto di piano scorrevole per laptop. Dotato di chiusure a farfalla in acciaio zincato, maniglia con ritorno a molla, angolari e rinforzi in acciaio zincato, profili in alluminio professionali e piedini industriali in gomma. Coperchio asportabile.

• Professional DJ controller cases that hold different small (DJCTRLC1S), medium (DJCTRLC2M) and large (DJCTRLC3L) format CONTROLLERS and laptop. Made by 5-Ply, phenolic-bond marine plywood, 9 mm thickness. Black laminated water and scratch-resistant covering. Inner foam padding, provided with extra high density foam pieces in order to fits different brands gear. Featuring sliding laptop tray. Equipped with recessed steel galvanized butterfly latches, recessed spring-loaded handles with rubber grip, steel ball-corner and stiffener, professional aluminium profile and industrial grade rubber feet. Removable lid.

DJCTRLC5XXL

• Custodia professionale per DJ adatta a contenere una vasta gamma di controller di grandi dimensioni, con le stesse caratteristiche dei modelli DJCTRLC1S/2M/3L. Il foam addizionale non è incluso. Questa custodia è particolarmente indicata per i modelli Pioneer® DDJ-SZ / DDJ-RZ - Numark® NS7II. Coperchio asportabile.

• Professional DJ controller case designed to house a wide range of large - sized controller, with the same characteristics of the models DJCTRLC1S / 2M / 3L. Additional foam not included. This case is particularly suitable for Pioneer® DDJ-SZ / DDJ-RZ - Numark® NS7II models. Removable lid.

TECH INFO

| CODE | INTERNAL BASE DIMENSION | WEIGHT |
|--------------|------------------------------|----------|
| DJCTRLC1S | 480 x 350 x 80 mm (base) | 8.50 kg |
| DJCTRLC2M | 660 x 435 x 113 mm (base) | 12.46 kg |
| DJCTRLC3L* | 805 x 460 x 115 mm (base) | 16.05 kg |
| DJCTRLC5XXL* | 870 x 420/500 x 50 mm (base) | 19.80 kg |

* Model provided with Ø 40 mm built-in wheels

FLIGHT CASES ACCESSORIES

FLIGHT CASES

AC103FS

- Ruota girevole ø 100 mm., doppio cuscinetto a sfera, freno a doppia azione, corpo in acciaio zincato 26 mm. Battistrada in gomma resilex blu. Confezione standard: 2 pezzi.
- Ø 100 mm (3.95 in) swivel-mount caster, double ball-bearing, dual-action brake (blocks wheel and swivel), 26 mm (1.0 in), galvanized steel frame and wheel, Blue Resilex rubber tread; Master pack: 2 pcs.



AC103GS

- Ruota girevole blu ø 100 mm., doppio cuscinetto a sfera, senza freno, corpo in acciaio zincato 26 mm. Battistrada in gomma resilex blu. Confezione standard: 2 pezzi.
- Ø 100 mm (3.95 in) swivel-mount caster, double ball-bearing, 26 mm (1.0 in), galvanized steel frame and wheel, Blue Resilex rubber tread; Master pack: 2 pcs.



AC107

- Montante rack in acciaio verniciato a polvere nera. Forato secondo standard internazionali. Lunghezza: 2 metri. Minima quantità ordinabile 2 metri.
- Steel Rack rail, black powder coated. Punched at international standard. Length: 2 m (78.7 in). Minimum order quantity 2 meters.



AC110

- Angolare bombato piccolo a tre gambe, 1 foro per lato, Acciaio zincato 1.2 mm. Fori ø 4.2 mm. Confezione standard: 4 pezzi.
- Small, 1.2mm (0.05 in) thick galvanized steel, triple-sided ball corners with single, elongated mounts on all three sides; Ø 4.2mm (0.17 in) mounting holes; Master pack: 4 pcs.



AC111

- Angolare bombato medio a tre gambe. Acciaio zincato 1.5 mm. Fori ø 5.1 mm. Confezione standard: 4 pezzi.
- Medium, 1.5mm (0.06 in) thick galvanized steel, triple-sided ball corners with single, elongated mounts on all three sides; Ø 5.1 mm (0.2 in) mounting holes; Master pack: 4 pcs.



AC112

- Angolare bombato grande in acciaio zincato 1.5 mm. Fori ø 5.1. confezione standard: 4 pezzi.
- Large, 1.5 mm (0.06 in) thick galvanized steel, triple-sided ball corners with double, elongated mounts on all three sides; Ø 5.1 mm (0.2 in) mounting holes; Master pack: 4 pcs.



AC113

- Maniglia ad incasso con ritorno a molla, impugnatura larga e lamina rinforzata nel piatto in acciaio profondo 8 mm. In acciaio zincato con impugnatura in PVC nero. Fori ø 5.1. Confezione standard: 2 pezzi.
- Recessed, spring-loaded, galvanized steel handles with enlarged, black PVC grip, and reinforced handle mount. Depth: 8 mm (0.3 in); Ø 5.1 mm (0.2 in) mounting holes; Master pack: 2 pcs.

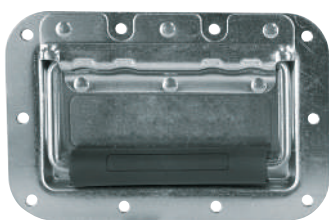

AC114

- Maniglia a striscia gommata nera con anima in acciaio, lamine in acciaio con agganci nichelati. Fori ø 5.1. Confezione standard: 2 pezzi.
- Black, rubber covered strip handle with steel core and nickel-steel mounts; Ø 5.1 mm (0.2 in) mounting holes; Master pack: 2 pcs.



AC116

- Chiusura a leva con chiave, in acciaio cromato. Fori ø 3.5 mm. Confezione standard: 4 pezzi.
- Chromed steel draw-bolt latches; Ø 3.5 mm (0.14 in) mounting holes; Master pack: 4 pcs.



AC117

- Chiusura a farfalla media montata su vaschetta, in acciaio zincato. Profondità 12 mm. Fori ø 5.1. Confezione standard: 2 pezzi.
- Medium, recessed, galvanized steel "butterfly" type latches; Depth: 12 mm (0.47 in); Ø 5.1 mm (0.2 in) mounting holes; Master pack: 2 pcs.

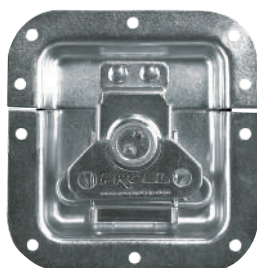

AC118

- Chiusura a farfalla piccola montata su vaschetta in acciaio zincato profondità 9 mm. Fori ø 5.1. Confezione standard: 2 pezzi.
- Small, recessed, galvanized steel "butterfly" type latches; Depth: 9mm (0.35 in) Ø 5.1 mm (0.2 in) mounting holes; Master pack: 2 pcs.

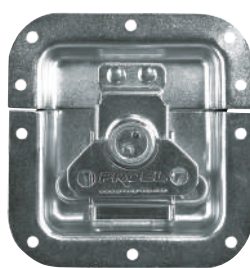

AC121

- Rinforzo grande in acciaio zincato 1.2 mm. Fori ø 5.1 mm. - Angolo retto. Confezione standard: 4 pezzi.
- Large, 1.2 mm (0.05 in) thick chromed plated steel, 90° corner brace; 4 x Ø 5.1 mm (0.2 in) mounting holes; Master pack: 4 pcs.



FLIGHT CASES ACCESSORIES

FLIGHT CASES

AC123Z

- Cerniera grande a reggicoperchio in acciaio zincato 1.2 mm. Fori ø 5 mm. Confezione standard: 2 pezzi.
- Large, 1.2 mm (0.05 in) thick galvanized steel hinge with lid support; 8 x ø 5 mm (0.2 in) mounting holes; Master pack: 2 pcs.



AC124

- Cerniera sganciabile ultrasensibile in acciaio temperato zincato 2.2 mm. Fori ø 5 mm. Confezione standard: 2 pezzi.
- Heavy-duty, detachable, 2.2 mm (0.09 in) thick tempered galvanized steel; 7 x ø 5 mm (0.2 in) mounting holes; Master pack: 2 pcs.



AC131

- Profilo reversibile in alluminio per pannello 7 mm. Lunghezza: 2 metri. Minima quantità ordinabile 2 metri.
- Reversible, interlocking, aluminum edging for 7mm (0.28 in) panel. Master pack: 2m (78.7 in) strip.

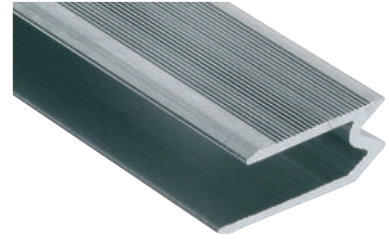

AC132

- Profilo reversibile in alluminio per pannello 10 mm. Lunghezza: 2 metri. Minima quantità ordinabile 2 metri.
- Reversible, interlocking, aluminum edging for 10mm (0.39 in) panel. Master pack: 2m (78.7 in) strip.

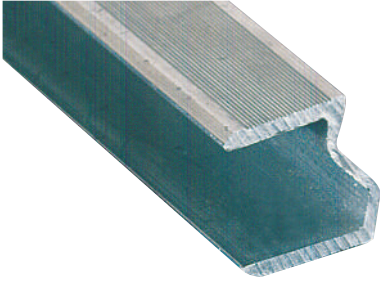

AC133

- Profilo angolare semplice in alluminio 22 x 22 mm. Lunghezza: 2 metri. Minima quantità ordinabile 2 metri.
- Single profile, 90° aluminum edging 22 mm (0.87 in) per side. Master pack: 2m (78.7 in) strip.

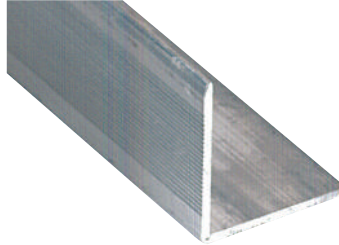

AC134

- Profilo angolare doppio in alluminio per pannello 7 mm. Lunghezza: 2 metri. Minima quantità ordinabile 2 metri.
- Double profile, slot-fit, 90° aluminum edging for 7 mm (0.28 in) panel. Master pack: 2m (78.7 in) strip.

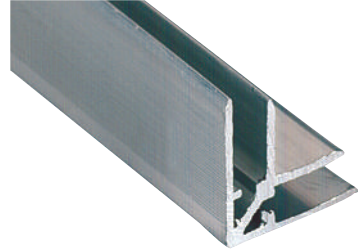

AC139 - AC140

- Rivestimento in spugna con adesivo per custodie. Poliestere grigio antracite. Spessore 5 (AC139), 10 (AC140). Altezza rotolo: 1220 mm.
- Anthracite-gray, adhesive polyester foam padding. Thickness: 5mm/0.2 in (AC139) - 10mm/0.39 in (AC140). Roll height: 1220 mm/48 in.



KIT12

- Kit di montaggio rack, composto da n. 12 AC104, n. 12 AC106 e n. 12 AC106C. Confezione standard: 10 set.
- Rack mounting set; includes 12 pcs. AC104, 12 pcs. AC106 and 12 pcs. AC106C. Master pack 10 set.



KIT12B

- Kit di montaggio rack, composto da n. 12 AC104, n. 12 AC106B e n. 12 AC106C. Confezione standard: 10 set.
- Rack mounting set; includes 12 pcs. AC104, 12 pcs. AC106B and 12 pcs. AC106C. Master pack 10 set.



AC169A

- Golfare "francese" in acciaio zincato nero MA10. Confezione standard: 1 pezzo.
- "French type" black galvanized steel eyebolt MA10; Master pack: 1 pc.



“PP” CASES

• Le custodie della serie PPCASE Proel, costruite con elevati standard qualitativi, sono state ideate e create per il trasporto e la protezione di apparecchiature delicate anche in condizioni estreme. Tutte le custodie sono costruite con materiale compound PP stampato ad iniezione che protegge da ruggine e corrosione, sono resistenti all'acqua, alla polvere e rinforzate in ogni angolo per la massima robustezza e durabilità; sono inoltre provviste di valvola per la regolazione della pressione interna e predisposte per la chiusura con lucchetto. Tutte le custodie sono fornite con rivestimento in “eggbox” foam all'interno del coperchio, mentre la base, tranne per le custodie sagomate per chitarra, è dotata di foam a cubetti personalizzabile, che permette di adattare l'interno per diverse tipologie di apparecchiature.

• The PPCASE series of Proel cases, built with high quality standards, have been designed and created to transport and protect sensitive equipment even in extreme conditions. All the cases are constructed of injection-molded PP compound material that protects against rust and corrosion, they are waterproof, dustproof and reinforced in each corner for maximum strength and durability; they are also equipped with a valve for the internal pressure regulation and geared for padlock closure. All enclosures are supplied with “eggbox” foam inside the lid, while the base, except the shaped models for guitar, has a customizable foam cubes, which allows to adapt the interior to wide range of equipment.



PROFESSIONAL INJECTION MOLDED UTILITY CASES

PP SERIES



PPCASE04

PPCASE05

PPCASE06



PPCASE04

• Valigia realizzata in compound di polipropilene modificato stampato ad iniezione. Dimensioni esterne: L 420 mm x P 330 mm x H 175 mm /Dimensioni interne: L 388 mm x P 268 mm x A 156 (110 + 46) mm. Colore nero.
• New modified polypropylene injection molded case. External dimensions: W 420 mm x D 330 mm x H 175 mm / Internal dimensions: W 388 mm x D 268 mm x H 156 (110 + 46) mm. Black color.

PPCASE05

• Valigia realizzata in compound di polipropilene modificato stampato ad iniezione. Dimensioni esterne: L 420 mm x P 330 mm x H 275 mm /Dimensioni interne: L 388 mm x P 268 mm x A 256 (210 + 46) mm. Colore nero.
• New modified polypropylene injection molded case. External dimensions: W 420 mm x D 330 mm x H 275 mm / Internal dimensions: W 388 mm x D 268 mm x H 256 (210 + 46) mm. Black color.

PPCASE06

• Valigia realizzata in compound di polipropilene modificato stampato ad iniezione. Dimensioni esterne: L 465 mm x P 400 mm x H 190 mm /Dimensioni interne: L 430 mm x P 340 mm x A 175 (130 + 45) mm. Colore nero.
• New modified polypropylene injection molded case. External dimensions: W 465 mm x D 400 mm x H 190 mm / Internal dimensions: W 430 mm x D 340 mm x H 175 (130 + 45) mm. Black color.

PROFESSIONAL INJECTION MOLDED UTILITY CASES

PP SERIES

PPCASE07



PPCASE08



PPCASE07

• Valigia realizzata in compound di polipropilene modificato stampato ad iniezione. Dimensioni esterne: L 465 mm x P 400 mm x H 290 mm /Dimensioni interne: L 430 mm x P 340 mm x A 275 (230 + 45) mm. Colore nero.
• New modified polypropylene injection molded case. External dimensions: W 465 mm x D 400 mm x H 290 mm / Internal dimensions: W 430 mm x D 340 mm x H 275 (230 + 45) mm. Black color.

PPCASE08

• Valigia realizzata in compound di polipropilene modificato stampato ad iniezione. Dimensioni esterne: L 550 mm x P 420 mm x H 205 mm /Dimensioni interne: L 490 mm x P 360 mm x A 200 (150 + 50) mm. Colore nero.
• New modified polypropylene injection molded case. External dimensions: W 550 mm x D 420 mm x H 205 mm / Internal dimensions: W 490 mm x D 360 mm x H 200 (150 + 50) mm. Black color.

PROFESSIONAL INJECTION MOLDED UTILITY CASES

PP SERIES



PPCASE09



PPCASE12W



PPCASE09

- Valigia realizzata in compound di polipropilene modificato stampato ad iniezione. Dimensioni esterne: L 580 x P 345 mm x H 190 mm / Dimensioni interne: L 520 mm x P 288 mm x A 185 (135 + 50) mm. Colore nero.
- New modified polypropylene injection molded case. External dimensions: W 580 mm x D 345 mm x H 190 mm / Internal dimensions: W 520 mm x D 288 mm x H 185 (135 + 50) mm. Black color.

PPCASE12W

- Valigia realizzata in compound di polipropilene modificato stampato ad iniezione. Dotata di pratica maniglia estraibile a scomparsa, con sistema di bloccaggio e ruote incassate nella struttura. Dimensioni esterne: L 580 mm x P 345 mm x H 230 mm / Dimensioni interne: L 520 mm x P 288 mm x A 200 (150 + 50) mm. Colore nero.
- New modified polypropylene injection molded case. Equipped with practical pull retractable handle, with locking system and recessed wheels in the structure. External dimensions: W 580 mm x D 345 mm x H 230 mm / Internal dimensions: W 520 mm x D 288 mm x H 200 (150 + 50) mm. Black color.

PROFESSIONAL INJECTION MOLDED UTILITY CASES

PP SERIES



PPCASE13W



PPCASE14W



PPCASE13W

Valigia realizzata in compound di polipropilene modificato stampato ad iniezione. Dotata di pratica maniglia estraibile a scomparsa, con sistema di bloccaggio e ruote incassate nella struttura. Dimensioni esterne: L 550 mm x P 420 mm x H 245 mm / Dimensioni interne: L 490 mm x P 360 mm x A 225 (175 + 50) mm. Colore nero.

New modified polypropylene injection molded case. Equipped with practical pull retractable handle, with locking system and recessed wheels in the structure. External dimensions: W 550 mm x D 420 mm x H 245 mm / Internal dimensions: W 490 mm x D 360 mm x H 225 (175 + 50) mm. Black color.

PPCASE14W

Valigia realizzata in compound di polipropilene modificato stampato ad iniezione. Dotata di pratica maniglia estraibile a scomparsa, con sistema di bloccaggio e ruote incassate nella struttura. Dimensioni esterne: L 710 mm x P 458 mm x H 280 mm / Dimensioni interne: L 650 mm x P 400 mm x A 250 (200 + 50) mm. Colore nero.

New modified polypropylene injection molded case. Equipped with practical pull retractable handle, with locking system and recessed wheels in the structure. External dimensions: W 710 mm x D 458 mm x H 280 mm / Internal dimensions: W 650 mm x D 400 mm x H 250 (200 + 50) mm. Black color.

FOAM CASES

• Linea di custodie per strumenti musicali realizzate esternamente in Nylon 600D e imbottite con resistente e leggero foam ad alta densità rivestito in elegante e protettivo velluto nero. Pratiche maniglie imbottite in tessuto a rete, robuste tracolle con ganci ed anelli in metallo; resistenti chiusure lampo con zip in pressofusione; capienti tasche per accessori e resistenti piedini d'appoggio antiscivolo in gomma naturale, sono le peculiarità salienti della FOAM series.

• This line of musical instrument cases is made with external Nylon 600D fabric, special tough lightweight high-density foam padding, internally lined with soft, elegant and protective black velvet. Reinforced mesh padded handles; shoulder straps with metal D-ring and hooks; strong zipper with die-cast pull; large pocket for accessories and strong anti-skid natural rubber feet, are added features of the "FOAM" series.



GUITAR FOAM CASES "PFOAM" SERIES

FOAM CASES

• CUSTODIE IN FOAM PER CHITARRA E BASSO •

Resistenti e leggere custodie per chitarra e basso, realizzate in Foam ad alta densità con esterno in Nylon 600D ed elegante rivestimento interno in velluto. Dotate di pratiche tasche esterne e scomparto interno per accessori, resistenti chiusure con zip in pressofusione e tracolle dotate di ganci ed anelli in metallo per un confortevole trasporto.

• **GUITAR & BASS FOAM CASES** • *Rugged and lightweight guitar and bass foam cases. Made with 600D Nylon fabric and special high-density foam padding. Internally lined with elegant, protective black velvet. Equipped with practical external pocket and inner compartment for accessories and cables, strong zipper with die-cast pull, anti-skid natural rubber feet, shoulder straps with metal hooks and D-ring for a comfortable carrying.*



PFOAM10

- Custodia in foam per chitarra classica.
- *Classic guitar foam case.*

PFOAM20

- Custodia in foam per chitarra acustica/folk.
- *Acoustic / folk guitar foam case.*

TECH INFO

| Model: | PFOAM10 | PFOAM20 |
|-------------------|--------------------|--------------------|
| Outside width: | 540 mm (11.81") | 540 mm (11.81") |
| Outside height: | 1100 mm (43.70") | 1100 mm (43.70") |
| Outside depth: | 170 mm (6.69") | 170 mm (6.69") |
| Weight: | 2.50 kg (5.51 lbs) | 2.50 kg (5.51 lbs) |
| Available colors: | Black | Black |
| Master Carton: | 4 pcs. | 4 pcs. |

BASS FOAM CASES "PFOAM" SERIES

FOAM CASES



PFOAM40

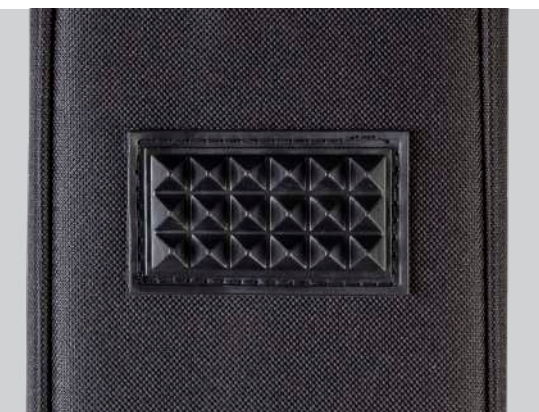

PFOAM30

PFOAM30

- Custodia in foam per chitarra elettrica.
- Electric guitar foam case.

PFOAM40

- Custodia in foam per basso elettrico.
- Electric bass foam case.

TECH INFO

| | PFOAM30 | PFOAM40 |
|--------------------------|--------------------|--------------------|
| Model: | PFOAM30 | PFOAM40 |
| Outside width: | 400 mm (00.00") | 400 mm (00.00") |
| Outside height: | 1050 mm (41.33") | 1268 mm (49.92") |
| Outside depth: | 140 mm (5.51") | 140 mm (5.51") |
| Weight: | 2.90 kg (6.39 lbs) | 3.80 kg (8.38 lbs) |
| Available colors: | Black | Black |
| Master Carton: | 4 pcs. | 4 pcs. |

ABS CASES

• FORCE Series è una linea di prodotti che comprende un'ampia gamma di custodie professionali dedicate al settore degli strumenti musicali e delle apparecchiature per il palcoscenico ed è parte integrante dei prodotti a brand PROEL.

La caratteristica principale di questa serie è rappresentata dal "mix" dei componenti e polimeri utilizzati, inclusa della fibra di carbonio, per la realizzazione dei pannelli usati nella costruzione delle custodie. Il risultato di tutto ciò è il "Polietilene FORCE" che coniuga un'eccellente resistenza alle sostanze chimiche ed agli agenti atmosferici, ed è al tempo stesso molto leggero e durevole nel tempo.

I pannelli così ottenuti sono sottoposti a dei processi termoplastici mediante l'uso di speciali macchine e stampi, per dare vita alle custodie di differenti forme e dimensioni che risultano essere molto maneggevoli e resistenti per le differenti esigenze dei professionisti.

• The FORCE series is a line of products that includes a wide range of professional cases dedicated to the field of musical instruments and stage equipment and is an integral part of PROEL brand products.

The main feature of this series is represented by the "mix" of components and polymers used, including the carbon fibre, for the realization of the panels used in the construction of the cases. The result of all this is the "FORCE Polyethylene" which combines excellent resistance to chemicals and weathering, and is at the same time very light and durable over time. The panels thus obtained are subjected to processes of thermoplastics through the use of special machines and molds, to give life to the enclosures of different shapes and sizes that prove to be very handy and resistant to the different needs of professionals.



19" RACK CASES "LOW" PROFILE - "FORCE" SERIES

ABS CASES

Custodie a rack 19" realizzate in "Polietilene FORCE". Questi modelli sono caratterizzati per la ridotta profondità del corpo e sono particolarmente adatti per l'installazione di apparecchiature elettroniche "low profile" e per apparati "wireless microphone".

- Leggero e resistente "Polietilene FORCE" usato per la struttura
- Confortevole maniglia laterale con ritorno a molla ed impugnatura in gomma
- Barra rack zincata anteriore e posteriore, con dotazione di viti e rondelle per il fissaggio delle apparecchiature
- Pratiche tasche a rete sui coperchi per riporre cavi ed accessori
- Hardware professionale
- **Profondità interna utile: 208 mm**

19" Shallow rack cases made of "FORCE Polyethylene". These models are characterized by the low depth of the body and are particularly suitable for the installation of "low profile" electronic equipment and wireless microphone systems.

- Lightweight «FORCE polyethylene» construction material
- Comfortable spring loaded and rubber covered side handle
- Front and rear threaded zinc-plated steel rack rails and numbers of screws and washers are included
- Lids equipped with practical zipped meshed pocket for cables and accessories storage
- Professional hardware
- **Inner rackable depth: 208 mm**



FOABSR3US



FOABSR3US



FOABSR6US



FOABSR6US



FOABSR4US

FOABSR2US

- Custodia Rack 19" "Low Profile" – 2U
- 19" "Low Profile" Rack Case – 2U

FOABSR3US

- Custodia Rack 19" "Low Profile" – 3U
- 19" "Low Profile" Rack Case – 3U

FOABSR4US

- Custodia Rack 19" "Low Profile" – 4U
- 19" "Low Profile" Rack Case – 4U

FOABSR6US

- Custodia Rack 19" "Low Profile" – 6U
- 19" "Low Profile" Rack Case – 6U

19" RACK CASES "MEDIUM" PROFILE - "FORCE" SERIES

ABS CASES

Custodie a rack 19" realizzate in Polietilene FORCE.

- Leggero e resistente "Polietilene FORCE" usato per la struttura
- Confortevoli maniglie laterali ad incasso
- Barra rack anteriore e posteriore in acciaio zincato, con dotazione di viti e rondelle per il fissaggio delle apparecchiature
- Pratiche tasche a rete sui coperchi per riporre cavi ed accessori
- Hardware professionale
- **Profondità interna utile: 307 mm**

19" Rack cases made of "FORCE Polyethylene".

- *Lightweight «FORCE polyethylene» construction material*
- *Comfortable recessed side handles*
- *Front and rear threaded zinc-plated steel rack rails and numbers of screws and washers are included*
- *Lids equipped with practical zipped meshed pocket for cables and accessories storage*
- *Professional hardware*
- **Inner rackable depth: 307 mm**



FOABSR3UM



FOABSR2UM



FOABSR4UM



FOABSR6UM



FOABSR2UM

- Custodia Rack 19" – corpo 12" – 2U
- 19" Rack Case – 12" body - 2U

FOABSR3UM

- Custodia Rack 19" – corpo 12" – 3U
- 19" Rack Case – 12" body - 3U

FOABSR4UM

- Custodia Rack 19" – corpo 12" – 4U
- 19" Rack Case – 12" body - 4U

FOABSR6UM

- Custodia Rack 19" – corpo 12" – 6U
- 19" Rack Case – 12" body - 6U

FOABSR8UM

- Custodia Rack 19" – corpo 12" – 8U
- 19" Rack Case – 12" body - 8U

19" RACK CASES - "FORCE" SERIES

ABS CASES

Custodie a rack 19" realizzate in Polietilene FORCE.

- Leggero e resistente "Polietilene FORCE" usato per la struttura
- Confortevoli maniglie laterali ad incasso
- Barra rack anteriore e posteriore in acciaio zincato, con dotazione di viti e rondelle per il fissaggio delle apparecchiature
- Pratiche tasche a rete sui coperchi per riporre cavi ed accessori
- Hardware professionale
- **Profondità interna utile: 420 mm**

19" Rack cases made of "FORCE Polyethylene".

- *Lightweight «FORCE polyethylene» construction material*
- *Comfortable recessed side handles*
- *Front and rear threaded zinc-plated steel rack rails and numbers of screws and washers are included*
- *Lids equipped with practical zipped meshed pocket for cables and accessories storage*
- *Professional hardware*
- **Inner rackable depth: 420 mm**



FOABSR3U



FOABSR2U



FOABSR2U



FOABSR4U

FOABSR6U

FOABSR2U

- Custodia Rack 19" – 2U
- 19" Rack Case – 2U

FOABSR3U

- Custodia Rack 19" – 3U
- 19" Rack Case – 3U

FOABSR4U

- Custodia Rack 19" – 4U
- 19" Rack Case – 4U

FOABSR6U

- Custodia Rack 19" – 6U
- 19" Rack Case – 6U

19" RACK CASES - "FORCE" SERIES

ABS CASES



FOABSR8U



FOABSR10U

FOABSR8U



FOABSR10U



FOABSR12U



FOABSR12U

FOABSR8U

- Custodia Rack 19" – 8U
- 19" Rack Case – 8U

FOABSR10U

- Custodia Rack 19" – 10U
- 19" Rack Case – 10U

FOABSR12U

- Custodia Rack 19" – 12U
- 19" Rack Case – 12U

19" RACK CASES WITH WHEEL - "FORCE" SERIES

ABS CASES

Custodie a rack 19" dalle stesse caratteristiche della serie precedente, con l'integrazione di una maniglia estraibile tipo trolley e ruote «roller-blade» style per un agevole trasporto.

- Leggero e resistente "Polietilene FORCE" usato per la struttura
 - Confortevoli maniglie laterali ad incasso
 - Barra rack anteriore e posteriore in acciaio zincato, con dotazione di viti e rondelle per il fissaggio delle apparecchiature
 - Pratiche tasche a rete sui coperchi per riporre cavi ed accessori
 - Hardware professionale
 - **Profondità interna utile: 420 mm**
 - Ruote tipo "roller-blade"
 - Pratica maniglia retrattile
- * L'unità in basso può essere utilizzata solo per apparati "low-profile"

19" rack cases with the same characteristics of the previous series, with the integration of a retractable trolley type handle and "roller-blade" style wheels for easy transport.

- *Lightweight «FORCE polyethylene» construction material*
 - *Comfortable recessed side handles*
 - *Front and rear threaded zinc-plated steel rack rails and numbers of screws and washers are included*
 - *Lids equipped with practical zipped meshed pocket for cables and accessories storage*
 - *Professional hardware*
 - **Inner rackable depth: 420 mm**
 - *Integrated pull-out handle and "roller-blade" style wheels*
- * 1 unit can only be used for low profile equipment due to the trolley mechanism

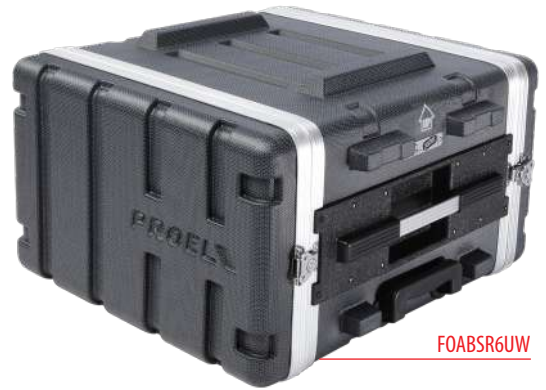

FOABSR6UW



FOABSR6UW



FOABSR8UW



FOABSR10UW



FOABSR10UW

FOABSR6UW

- Custodia Rack 19" – 5+1U con trolley
- 19" Rack Case with trolley - 5U + 1U*

FOABSR8UW

- Custodia Rack 19" – 7+1U con trolley
- 19" Rack Case with trolley - 7U + 1U*

FOABSR10UW

- Custodia Rack 19" – 9+1U con trolley
- 19" Rack Case with trolley - 9U + 1U*

19" MIXER RACK CASE & MICROPHONE CASES - "FORCE" SERIES

ABS CASES

Della serie di custodie fanno inoltre parte i seguenti prodotti:

- Custodia professionale a rack 19" per mixer 12U con sistema "pop-up" per la regolazione dell'inclinazione.
- Custodie per microfono dotate di inserti sagomati in foam per l'inserimento dei microfoni e di un pratico vano laterale per l'alloggiamento di cavi ed accessori.
- "Polietilene FORCE" per la realizzazione della struttura
- Hardware professionale

This series case also includes the following products:

- 19" Professional rack case for 12U mixer with "pop-up" ratchet adjustable system
- Microphone cases with molded foam insert for insertion of microphones and a practical side compartment for cables and accessories.
- Lightweight «FORCE polyethylene» construction material
- Professional hardware



FOABSMIX12



FOABSMIC12



FOABSMIX12

- Custodia Per Mixer A Rack 19" Pop-Up - 12U
- 19" Rack Mixer Case - 12U - With Pop-Up System

FOABSMIC9

- Custodia per 9 Microfoni
- Case For 9 Microphones



FOABSMIC9

FOABSMIC12

- Custodia per 12 Microfoni
- Case For 12 Microphones

GUITAR CASES - "FORCE" SERIES

ABS CASES

Serie di custodie sagomate e rettangolari per chitarra, realizzate in resistente Polietilene FORCE con imbottitura interna in espanso rivestito di morbido velluto grigio dello spessore di 7mm per offrire un'adeguata protezione allo strumento.

- Leggero e resistente "Polietilene FORCE" usato per la struttura
- Rivestimento interno in morbido velluto grigio di 7mm di spessore per un'adeguata protezione dello strumento
- Hardware professionale

Series of shaped and rectangular guitar cases made of "FORCE Polyethylene" with inner strong foam frame covered with 7 mm grey colour soft velvet offering good protection to the instrument.

- Lightweight «FORCE polyethylene» construction material
- 7 mm light gray velvet inner lining
- Professional hardware



FOABSCGC



FOABSAGC



FOABSEGC

FOABSEBC



FOABSEBC

FOABSCGC

- Custodia sagomata per chitarra classica
- Classic guitar shaped case

FOABSAGC

- Custodia sagomata per chitarra acustica
- Acoustic / folk guitar shaped case

FOABSEGC

- Custodia rettangolare per chitarra elettrica
- Electric guitar rectangular case

FOABSEBC

- Custodia rettangolare per basso elettrico
- Electric bass rectangular case

WOODEN CASES

• La rinnovata linea di custodie in legno "CWC Series" rappresenta l'implementazione della gamma di custodie per un affidabile protezione, trasporto e stoccaggio degli strumenti musicali, con particolare riferimento alle chitarre ed ai bassi, dove abbiamo ampliato la gamma dei prodotti per offrire una maggiore scelta agli utilizzatori finali. Rappresentano una soluzione ideale per soddisfare le esigenze di durevolezza e funzionalità. Tutti i prodotti sono realizzati con una struttura rigida che stabilizza lo strumento, con l'utilizzo di materie prime di alta qualità, hardware professionale in metallo e finiture esterne in similpelle e tessuto. Le robuste chiusure assicurano un'ottimale tenuta del coperchio ed una è fornita di pratico lucchetto con chiave. La maniglia di trasporto, centrata, consente un trasporto equilibrato e confortevole. Gli interni sono rivestiti in morbido velluto per una migliore protezione degli strumenti e presentano un pratico vano per contenere piccoli accessori e materiali di consumo.

The reissued line of CWC Series wooden cases from Proel represents the "best of breed" for reliable protection, transport and storage of musical instruments. With particular focus on guitars and basses, we have expanded the range of products to offer greater choice for end users. Super durable with ultimate functionality, all the cases are made with a rigid structure that secures the instrument. Fabricated with the use of the highest quality materials, we use only professional metal hardware and external finishes in vinyl and fabric. The sturdy latches ensure an optimal lid seal and each one is equipped with a practical built-in lock, operated by key. The "centred" carrying handle allows a balanced and comfortable transport. The interior is lined with soft velvet for better protection and features a practical compartment to hold small accessories and consumables.



WOODEN GUITAR CASES "CWC" SERIES

WOODEN CASES



CWAG



CWCCG



CWAG **NEW**

• Custodia sagomata in legno per chitarra acustica/folk, con rivestimento esterno in similpelle ed interno in morbido velluto nero.
• Shaped wooden case for acoustic/folk guitar with a vinyl exterior covering and a soft black velvet interior.

CWCCG **NEW**

• Custodia sagomata in legno per chitarra classica, con rivestimento esterno in similpelle ed interno in morbido velluto nero.
• Shaped wooden case for classical guitar with a vinyl exterior covering and a soft black velvet interior.

WOODEN GUITAR CASES "CWC" SERIES

WOODEN CASES



CWCEGR



CWCEBR



CWCEGR **NEW**

• Custodia rettangolare in legno per chitarra elettrica, con rivestimento esterno in similpelle ed interno in morbido velluto nero.
• Rectangular wooden case for electric guitar with a vinyl exterior covering and a soft black velvet interior.

CWCEBR **NEW**

• Custodia rettangolare in legno per basso elettrico, con rivestimento esterno in similpelle ed interno in morbido velluto nero.
• Rectangular wooden case for electric bass with a vinyl exterior covering and a soft black velvet interior.

WOODEN GUITAR CASES "CWC" SERIES

WOODEN CASES



CWCEGT



CWCEBT

CWCEGT **NEW**

- Custodia sagomata a goccia in legno per chitarra elettrica, con rivestimento esterno in similpelle ed interno in morbido velluto nero. Grazie alla sua conformazione può contenere diverse tipologie di chitarre elettriche.
- *Shaped teardrop wooden case for electric guitar with an external vinyl covering and an interior lining in soft black velvet. (Constructed to fit most common shapes of electric guitar.)*

CWCEBT **NEW**

- Custodia sagomata a goccia in legno per basso elettrico, con rivestimento esterno in similpelle ed interno in morbido velluto nero. Grazie alla sua conformazione può contenere diverse tipologie di bassi elettrici.
- *Shaped teardrop wooden case for electric bass with an external vinyl covering and an interior lining in soft black velvet. (Constructed to fit most common shapes of electric bass.)*

WOODEN GUITAR CASES "CWC" SERIES

WOODEN CASES



CWCAGX



CWCCGX



CWCCGX **NEW**

- Custodia sagomata vintage in legno per chitarra classica, con rivestimento esterno in similpelle di colore marrone ed interno in morbido velluto color vinaccia.
- *Vintage shaped wooden case for classical guitar with an external covering in brown vinyl and an interior lining in soft burgundy velvet.*

CWCAGX **NEW**

- Custodia sagomata vintage in legno per chitarra acustica/folk, con rivestimento esterno in similpelle di colore marrone ed interno in morbido velluto color vinaccia.
- *Vintage shaped wooden case for acoustic/folk guitar with an external covering in brown vinyl and an interior lining in soft burgundy velvet.*

WOODEN GUITAR CASES "CWC" SERIES

WOODEN CASES

CWCEBRX



CWCEGRX

CWCEGRX **NEW**

- Custodia rettangolare in legno per chitarra elettrica, con rivestimento esterno in tessuto vintage ed interno in morbido velluto color vinaccia.
- Rectangular wooden case for electric guitar with a vintage fabric covering and an interior lining in soft burgundy velvet.

CWCEBRX **NEW**

- Custodia rettangolare in legno per basso elettrico, con rivestimento esterno in tessuto vintage ed interno in morbido velluto color vinaccia.
- Rectangular wooden case for electric guitar with a vintage fabric covering and an interior lining in soft burgundy velvet.



BAGS & STRAPS

• PROEL è lieta di presentare una linea completamente nuova di borse e tracolle per il mercato musicale, concepita per soddisfare le esigenze di ogni utente finale, dall'amatore al musicista professionista. Grazie ad una costante attività di ricerca ed ai suggerimenti di musicisti di ogni parte del mondo abbiamo ridisegnato la nostra gamma di borse e tracolle. Tutto ciò ha significato particolari ergonomici perfezionati, materiali più resistenti, maniglie e tracolle più sicure. Tutto ciò che è necessario per una linea professionale all'avanguardia. Usiamo materiali controllati e di alta qualità, e prestiamo attenzione ad ogni singolo dettaglio di fabbricazione: cerniere in metallo, rivestimenti resistenti, maniglie sicure. La linea PROEL "Bags & Straps" è il mix ottimale tra qualità e prezzi competitivi.

• PROEL is glad to introduce a completely new line of bags and straps for the musical market, designed to meet any end user need, from amateurs to professional musicians. Thanks to a constant research and to inputs received by musicians around the world, we have redesigned our range of bags and straps. That has resulted in enhanced ergonomic details, stronger materials, safer handles and straps. Everything that is necessary for a "state-of-the-art" professional line.

We use the best tested materials and pay attention to every single manufacturing detail: strong metal zips, heavy padding, safe handles. PROEL "Bags & Straps" line is the perfect mix between quality and competitive prices.



GUITAR & BASS BAGS "100" SERIES

BAGS AND STRAPS

• Linea di borse morbide per chitarre "100 Series", pensata per soddisfare le esigenze degli studenti che approcciano il mondo degli strumenti musicali, garantendo assoluta resistenza ed un'indubbia praticità. Le borse sono realizzate in morbido Nylon 420D antistrappo con bordatura in nastro telato. Sono dotate di confortevoli maniglie rinforzate con chiusura in velcro e di resistenti tracolle regolabili con anelli in metallo; provviste di ampie tasche anteriori per libri di musica ed accessori e di resistenti chiusure lampo con tiranti in metallo pressofuso.

• The "100" series of soft guitar bags has been designed to satisfy the need of students who are taking their first steps into the world of musical instruments. Highly resistant and highly practical, the bags are made with a soft, rip proof 420D Nylon with a cloth outer borders. The "100" series line bags are equipped with comfortable handles, reinforced with Velcro, a resistant adjustable shoulder strap secured to the bag with metal rings and with wide pockets for music books and accessories. The bags also feature resistant zips with die cast pull tags.



BAG110PN

BAG100PN



BAG100PN

- Borsa per chitarra Classica in nylon 420D antistrappo. Disponibile nel colore nero.
- Rip-proof nylon 420D classic guitar bag. Available in black.

BAG110PN

- Borsa per chitarra Acustica/Folk in nylon 420D antistrappo. Disponibile nel colore nero.
- Rip-proof nylon 420D acoustic guitar bag. Available in black.

GUITAR & BASS BAGS "100" SERIES

BAGS AND STRAPS

BAG120PN



BAG130PN



BAG140PN



BAG120PN

- Borsa per chitarra Elettrica in nylon 420D antistrappo. Disponibile nel colore nero.
- *Rip-proof nylon 420D electric guitar bag. Available in black.*

BAG130PN

- Borsa per Basso elettrico in nylon 420D antistrappo. Disponibile nel colore nero.
- *Rip-proof nylon 420D bass bag. Available in black.*

BAG140PN

- Borsa per chitarra Classica 3/4 in nylon 420D antistrappo. Disponibile nel colore nero.
- *Rip-proof nylon 420D 3/4 classic guitar bag. Available in black.*

TECH INFO

| | |
|----------------------------------|--|
| Models | BAG100PN - BAG110PN - BAG120PN - BAG130PN - BAG140PN |
| Application fields | 3/4 Classic guitars, Classic guitar, Acoustic/Folk guitars, Electric guitars and Electric basses |
| Outer material | Rip-proof padded Nylon 420D with cloth outer edge-banding |
| Padding | Not available |
| Handles & straps | Strengthened Velcro strap handle - Adjustable straps with metal ring |
| Pockets & accessories | Two wide front pockets for Music book and accessories. Resistant zips with die cast pull tags |
| Available colours | Black |

GUITAR & BASS BAGS "150" SERIES

BAGS AND STRAPS

• Serie di borse morbide per chitarre '150 Series', ideata per i musicisti amatoriali alla ricerca di un prodotto resistente, pratico ed allo stesso tempo non dispendioso. Costruite con morbido poliestere 600D antistrappo, imbottite con poliuretano ad alta densità dello spessore di 10 mm e rivestite internamente in Nylon 90D con inserti rinforzati a protezione del ponte e della paletta. Pratica maniglia laterale per il trasporto. Tracolle imbottite regolabili, con occhielli in metallo ed inserti catarifrangenti. Provviste di ampie tasche anteriori per libri di musica ed accessori e di resistenti chiusure lampo con tiranti in metallo pressofuso.

• The '150 Series' of soft guitar bags, has been designed for amateur musicians who are looking for a resistant, practical and at the same time inexpensive product. Made with soft rip-proof 600D polyester, padded with 10 mm high-density polyurethane and internally lined in 90D Nylon with reinforced inserts to protect the bridge and headstock. Practical side handle for transport. Adjustable padded shoulder straps, with metal eyelets and reflective inserts. Equipped with large front pockets for music books and accessories and resistant zippers with die-cast metal zip puller.



BAG150B



BAG150A

BAG150A **NEW**

- Borsa per chitarra Acustica/Folk in poliestere 600D antistrappo con imbottitura da 10mm. Disponibile nel colore nero.
- Acoustic/Folk guitar bag, rip-proof 600D polyester, 10mm high density foam padding. Available in Black.

BAG150B **NEW**

- Borsa per basso Elettrico in poliestere 600D antistrappo con imbottitura da 10mm. Disponibile nel colore nero.
- Electric bass bag, rip-proof 600D polyester, 10mm high density foam padding. Available in Black.

GUITAR & BASS BAGS "150" SERIES

BAGS AND STRAPS



BAG150C34



BAG150C



BAG150E



BAG150C



BAG150C **NEW**

- Borsa per chitarra Classica in poliestere 600D antistrappo con imbottitura da 10mm. Disponibile nel colore nero.
- *Classic guitar bag, rip-proof 600D polyester, 10mm high density foam padding. Available in Black.*

BAG150C34 **NEW**

- Borsa per chitarra Classica 3/4 in poliestere 600D antistrappo con imbottitura da 10mm. Disponibile nel colore nero.
- *3/4 Classic guitar bag, rip-proof 600D polyester, 10mm high density foam padding. Available in Black.*

BAG150E **NEW**

- Borsa per chitarra Elettrica in poliestere 600D antistrappo con imbottitura da 10mm. Disponibile nel colore nero.
- *Electric guitar bag, rip-proof 600D polyester, 10mm high density foam padding. Available in Black.*

TECH INFO

| | |
|----------------------------------|--|
| Models | BAG150A - BAG150B - BAG150C - BAG150C34 - BAG150E |
| Application fields | 3/4 Classic guitars, Classic guitars, Acoustic/Folk guitars, Electric guitars and Electric basses |
| Outer material | Rip-proof padded 600D polyester with cloth inner/outer edge-banding |
| Padding | 10 mm high densityt foam, covered with 90D nylon and reinforced parts to protect strings, tuning machines, headstock and bridge |
| Handles & straps | Practical side handle for transport - Adjustable padded shoulder straps with metal eyelets and reflective inserts |
| Pockets & accessories | Upper pocket for accessories - Large front pocket for music books and accessories - Durable zippers with die-cast metal zip puller |
| Available colours | Black |

GUITAR & BASS BAGS "200" SERIES

BAGS AND STRAPS

• La serie di borse morbide per chitarre "200 Series", è stata ideata per i musicisti amatoriali alla ricerca di un prodotto resistente, pratico ed allo stesso tempo non dispendioso. Costruite con morbido Nylon 420D antistrappo con bordatura in nastro telato, imbottito con poliuretano ad alta densità dello spessore di 10 mm e rivestito internamente in Nylon 90D con inserti rinforzati a protezione del ponte e della paletta. Sono dotate di confortevole maniglia imbottita ricoperta in PVC con chiusura a strappo in velcro. Tracolle con inserti imbottiti, regolabili con anelli in metallo. Provviste di ampie tasche anteriori per libri di musica ed accessori e di resistenti chiusure lampo con tiranti in metallo pressofuso.

• The "200" series of guitar bags has been designed for the amateur musician who is looking for a bag that is both resistant and practical, yet at the same time at a right price level. Constructed from soft 420D tear proof Nylon with cloth outer borders, the "200" series bags feature resistant 10mm high density foam padding and a 90D Nylon interior, with reinforcement at the headstock and the bridge. The handles are padded for maximum comfort, can be closed with Velcro. The bags also feature a conveniently placed back handle made from reinforced Nylon. The padded shoulder strap is adjustable and secured to the bag with sturdy metal rings. Wide pockets are positioned on the front of the bags for music books and accessories and the resistant zips feature die cast pull tags.



BAG200PN



BAG210PN



BAG200PN

- Borsa per chitarra Classica in nylon 420D antistrappo con imbottitura da 10mm. Disponibile nel colore nero.
- Classic guitar bag, rip-proof nylon 420D, 10mm high density foam padding. Available in Black.

BAG210PN

- Borsa per chitarra Acustica / Folk in nylon 420D antistrappo con imbottitura da 10 mm . Disponibile nel colore nero.
- Acoustic/folk guitar bag, rip-proof nylon 420D, 10mm high density foam padding. Available in Black.

GUITAR & BASS BAGS "200" SERIES

BAGS AND STRAPS



BAG220PN

BAG230PN

BAG240PN

BAG220PN

- Borsa per chitarra Elettrica in nylon 420D antistrappo con imbottitura da 10 mm . Disponibile nel colore nero.
- *Electric guitar bag, rip-proof nylon 420D, 10mm high density foam padding. Available in Black.*

BAG230PN

- Borsa per Basso elettrico in nylon 420D antistrappo con imbottitura da 10 mm . Disponibile nel colore nero.
- *Classic bass bag, rip-proof nylon 420D, 10mm high density foam padding. Available in Black.*

BAG240PN

- Borsa per chitarra Classica 3/4 in nylon 420D antistrappo con imbottitura da 10mm. Disponibile nel colore nero.
- *3/4 Classic guitar bag, rip-proof nylon 420D, 10mm high density foam padding. Available in Black.*

TECH INFO

| | |
|----------------------------------|--|
| Models | BAG200PN - BAG210PN - BAG220PN - BAG230PN - BAG240PN |
| Application fields | 3/4 Classic guitars, Classic guitars, Acoustic/Folk guitars, Electric guitars and Electric basses |
| Outer material | Rip-proof padded Nylon 420D with cloth inner/outer edge-banding |
| Padding | 10mm high densityt foam, covered with 90D nylon and reinforced parts to protect strings, tuning machines, headstock and bridge |
| Handles & straps | Resistant Velcro strap handle - Strengthened back handle - Adjustable double padded shoulder straps with metal rings. |
| Pockets & accessories | Wide front pockets for Music book and accessories. Resistant zips with die cast pull tags |
| Available colours | Black |

GUITAR & BASS BAGS "FORCE" SERIES

BAGS AND STRAPS

La borse per chitarra della serie "FORCE", sono il risultato di una ricerca di mercato votata al raggiungimento degli standard di praticità e resistenza. Le borse sono realizzate in resistente nylon 1680D "waterproof" con imbottitura in foam ad alta densità da 15mm e con inserti extra all'interno per la protezione delle meccaniche del ponte e della paletta. Le maniglie sono realizzate in Nylon rinforzato e sono dotate di tracolle imbottite regolabili e chisure a zip estremamente resistenti. Ampie tasche sono posizionate sulla parte anteriore della borsa, per contenere libri di musica ed accessori.

• The "FORCE" series guitar bags are the result of a market research devoted to achieving the standard for convenience and resistance. The bags are made of durable 1680D "waterproof" nylon, padded with 15 mm high density foam and with extra inserts inside to protect the mechanics of the guitar bridge and headstock. The bags have handles made of reinforced nylon and are equipped with adjustable padded shoulder straps and extremely durable zip. Large pockets are located on the front of the bag, to hold music books and accessories.



FOAGBAG



FOEBBAG

FOAGBAG

- Borsa per Chitarra Acustica/Folk in nylon 1680D "waterproof" con imbottitura da 15mm. Disponibile nel colore nero.
- Acoustic/Folk Guitar bag, "waterproof" nylon 1680D, 15mm high density foam padding. Available in Black.

FOEBBAG

- Borsa per Basso Elettrico in nylon 1680D "waterproof" con imbottitura da 15mm. Disponibile nel colore nero.
- Electric Bass bag, "waterproof" nylon 1680D, 15mm high density foam padding. Available in Black.

GUITAR & BASS BAGS "FORCE" SERIES

BAGS AND STRAPS



FOCGBAG

- Borsa per Chitarra Classica in nylon 1680D "waterproof" con imbottitura da 15mm. Disponibile nel colore nero.
- Classic Guitar bag, "waterproof" nylon 1680D, 15mm high density foam padding. Available in Black.

FOEBAG

- Borsa per Chitarra Elettrica in nylon 1680D "waterproof" con imbottitura da 15mm. Disponibile nel colore nero.
- Electric Guitar bag, "waterproof" nylon 1680D, 15mm high density foam padding. Available in Black.

TECH INFO

| | |
|----------------------------------|--|
| Models | FOCGBAG - FOAGBAG - FOEBAG - FOEBBAG |
| Application fields | Classic guitars , Acoustic/Folk guitars, Electric guitars and Electric basses |
| Outer material | 1680D "waterproof" Polyesthere outer material |
| Padding | 15mm high density foam and reinforced parts to protect strings, tuning machines, headstock and bridge. |
| Handles & straps | Resistant Velcro strap handle - Practical adjustable padded shoulder straps |
| Pockets & accessories | Large pockets for Music book and accessories. Resistant zips with die cast pull tags |
| Available colours | Black with special inserts with line background theme |

KEYBOARD BAGS "900" SERIES

BAGS AND STRAPS



BAG966PN



BAG910PN



BAG930PN



BAG935PN



BAG940PN



BAG900PN

BAG900PN

- Borsa per tastiera in robusto nylon 420D antistrappo. Dimensioni: 970 (larghezza) x 400 (profondità) x 150 (altezza) mm. Imbottitura 20 mm. Disponibile in colore nero.
- *Heavy duty rip-proof nylon 420D keyboard bag. Inner dimensions: 970 (width) x 400 (depth) x 150 (height) mm. 20mm soft foam padding. Available in black.*

BAG910PN

- Borsa per tastiera in robusto nylon 420D antistrappo. Dimensioni: 1060 (larghezza) x 430 (profondità) x 180 (altezza) mm. Imbottitura 20 mm. Disponibile in colore nero.
- *Heavy duty rip-proof nylon 420D keyboard bag. Inner dimensions: 1060 (width) x 430 (depth) x 180 (height) mm. 20mm soft foam padding. Available in black.*

BAG920PN

- Borsa per tastiera in robusto nylon 420D antistrappo. Dimensioni: 1150 (larghezza) x 450 (profondità) x 180 (altezza) mm. Imbottitura 20 mm. Disponibile in colore nero.
- *Heavy duty rip-proof nylon 420D keyboard bag. Inner dimensions: 1150 (width) x 450 (depth) x 180 (height) mm. 20mm soft foam padding. Available in black.*

BAG930PN

- Borsa per tastiera in robusto nylon 420D antistrappo. Dimensioni: 1220 (larghezza) x 420 (profondità) x 160 (altezza) mm. Imbottitura 20 mm. Disponibile in colore nero.
- *Heavy duty rip-proof nylon 420D keyboard bag. Inner dimensions: 1220 (width) x 420 (depth) x 160 (height) mm. 20mm soft foam padding. Available in black.*

BAG935PN

- Borsa per tastiera in robusto nylon 420D antistrappo. Dimensioni: 1380 (larghezza) x 380 (profondità) x 160 (altezza) mm. Imbottitura 20 mm. Disponibile in colore nero.
- *Heavy duty rip-proof nylon 420D keyboard bag. Inner dimensions: 1380 (width) x 380 (depth) x 160 (height) mm. 20mm soft foam padding. Available in black.*

BAG938PN

- Borsa per tastiera in robusto nylon 420D antistrappo. Dimensioni: 1430 (larghezza) x 340 (profondità) x 140 (altezza) mm. Imbottitura 20 mm. Disponibile in colore nero.
- *Heavy duty rip-proof nylon 420D keyboard bag. Inner dimensions: 1430 (width) x 340 (depth) x 140 (height) mm. 20mm soft foam padding. Available in black.*

BAG940PN

- Borsa per tastiera in robusto nylon 420D antistrappo. Dimensioni: 1450 (larghezza) x 460 (profondità) x 170 (altezza) mm. Imbottitura 20 mm. Disponibile in colore nero.
- *Heavy duty rip-proof nylon 420D keyboard bag. Inner dimensions: 1450 (width) x 460 (depth) x 170 (height) mm. 20mm soft foam padding. Available in black.*

BAG966PN

- Borsa per tastiera in robusto nylon 420D antistrappo. Dimensioni: 660 (larghezza) x 260 (profondità) x 85 (altezza) mm. Imbottitura 8 mm. Disponibile in colore nero.
- *Heavy duty rip-proof nylon 420D keyboard bag. Inner dimensions: 660 (width) x 260 (depth) x 85 (height) mm. 8 mm soft foam padding. Available in black.*

DRUM BAGS "BAGD" SERIES

BAGS AND STRAPS



BAGD13PN



BAGD12PN



BAGD10PN

| TECH INFO | DIMENSION | TYPE |
|-------------------|------------|---------------|
| BAGD10PN | 9" x 10" | Tom |
| BAGD12PN | 10" x 12" | Tom |
| BAGD13PN | 11" x 13" | Tom |
| BAGD14PN | 14" x 14" | Tom |
| BAGD14PTN | 12" x 14" | Tom/Floor Tom |
| BAGD14SPN | 5.5" x 14" | Snare Drum |
| BAGD14DSPN | 6.5" x 14" | Snare Drum |
| BAGD16PN | 16" x 16" | Floor Tom |
| BAGD16PTN | 14" x 16" | Floor Tom |
| BAGD18PTN | 16" x 18" | Bass Drum |
| BAGD20PN | 18" x 20" | Bass Drum |
| BAGD22PN | 18" x 22" | Bass Drum |

BAGD10PN

- Borsa professionale per tom 9" x 10" (altezza e diametro), in robusto nylon 420D antistrappo. Imbottitura 10 mm. Disponibile in colore nero.
- Professional heavy duty rip-proof nylon 420D bag, 10mm high density foam padding, for 9" x 10" (height and diameter) tom. Available in black.

BAGD12PN

- Borsa professionale per tom 10" x 12" (altezza e diametro), in robusto nylon 420D antistrappo. Imbottitura 10 mm. Disponibile in colore nero.
- Professional heavy duty rip-proof nylon 420D bag, 10mm high density foam padding, for 10" x 12" (height and diameter) tom. Available in black.

BAGD13PN

- Borsa professionale per tom 11" x 13" (altezza e diametro), in robusto nylon 420D antistrappo. Imbottitura 10 mm. Disponibile in colore nero.
- Professional heavy duty rip-proof nylon 420D bag, 10mm high density foam padding, for 11" x 13" (height and diameter) tom. Available in black.

DRUM BAGS "BAGD" SERIES

BAGS AND STRAPS



BAGD14PN



BAGD16PN



BAGD14PTN



BAGD14SPN



BAGD14DSPN



BAGD16PTN

BAGD14PN

- Borsa professionale per tom 14" x 14" (altezza e diametro), in robusto nylon 420D antistrappo. Imbottitura 10 mm. Disponibile in colore nero.
- Professional heavy duty rip-proof nylon 420D bag, 10mm high density foam padding, for 14" x 14" (height and diameter) tom. Available in black.

BAGD16PN

- Borsa professionale per timpano 16" x 16" (altezza e diametro), in robusto nylon 420D antistrappo. Imbottitura 10 mm. Disponibile in colore nero.
- Professional heavy duty rip-proof nylon 420D bag, 10mm high density foam padding, for 16" x 16" (height and diameter) floor tom. Available in black.

BAGD14PTN

- Borsa professionale per tom e timpano 12" x 14" (altezza e diametro), in robusto nylon 420D antistrappo. Imbottitura 10 mm. Disponibile in colore nero.
- Professional heavy duty rip-proof nylon 420D bag, 10mm high density foam padding, for 12" x 14" (height and diameter) tom and floor tom. Available in black.

BAGD16PTN

- Borsa professionale per timpano 14" x 16" (altezza e diametro), in robusto nylon 420D antistrappo. Imbottitura 10 mm. Disponibile in colore nero.
- Professional heavy duty rip-proof nylon 420D bag, 10mm high density foam padding, for 14" x 16" (height and diameter) floor tom. Available in black.

BAGD14SPN

- Borsa professionale per rullante 5.5" x 14" (altezza e diametro), in robusto nylon 420D antistrappo. Imbottitura 10 mm. Disponibile in colore nero.
- Professional heavy duty rip-proof nylon 420D bag, 10mm high density foam padding, for 5.5" x 14" (height and diameter) snare drum. Available in black.

BAGD14DSPN

- Borsa professionale per rullante 6.5" x 14" (altezza e diametro), in robusto nylon 420D antistrappo. Imbottitura 10 mm. Disponibile in colore nero.
- Professional heavy duty rip-proof nylon 420D bag, 10mm high density foam padding, for 6.5" x 14" (height and diameter) snare drum. Available in black.



BAGD14DSPN

DRUM BAGS "BAGD" SERIES

BAGS AND STRAPS



BAGD20PN



BAGD18PN

- Borsa professionale per grancassa 16" x 18" (altezza e diametro), in robusto nylon 420D antistrappo. Imbottitura 10 mm. Disponibile in colore nero.
- Professional heavy duty rip-proof nylon 420D bag, 10mm high density foam padding, for 16" x 18" (height and diameter) bass drum. Available in black.

BAGD20PN

- Borsa professionale per grancassa 18" x 20" (altezza e diametro), in robusto nylon 420D antistrappo. Imbottitura 10 mm. Disponibile in colore nero.
- Professional heavy duty rip-proof nylon 420D bag, 10mm high density foam padding, for 18" x 20" (height and diameter) bass drum. Available in black.

BAGD22PN

- Borsa professionale per grancassa 18" x 22" (altezza e diametro), in robusto nylon 420D antistrappo. Imbottitura 10 mm. Disponibile in colore nero.
- Professional heavy duty rip-proof nylon 420D bag, 10mm high density foam padding, for 18" x 22" (height and diameter) bass drum. Available in black.



BAGD22PN

DRUM BAGS "BAGD" SERIES SET

| | CODE | DIMENSIONS | DRUM |
|---------------|------------|------------|---------------|
| BAG700PLUSN | BAGD10PN | 9" x 10" | tom |
| | BAGD12PN | 10" x 12" | tom |
| | BAGD14PN | 14" x 14" | tom/floor tom |
| | BAGD20PN | 18" x 20" | bass drum |
| | BAGD14DSPN | 6.5" x 14" | snare drum |
| BAG700MASTERN | BAGD12PN | 10" x 12" | tom |
| | BAGD13PN | 11" x 13" | tom |
| | BAGD16PN | 16" x 16" | tom/floor tom |
| | BAGD22PN | 18" x 22" | bass drum |
| | BAGD14DSPN | 6.5" x 14" | snare drum |
| BAG700ROCKN | BAGD10PN | 9" x 10" | tom |
| | BAGD12PN | 10" x 12" | tom |
| | BAGD14PTN | 12" x 14" | tom |
| | BAGD16PTN | 14" x 16" | tom/floor tom |
| | BAGD22PN | 18" x 22" | bass drum |
| | BAGD14DSPN | 6.5" x 14" | snare drum |



BAG700ROCKN
BAG700PLUSN
BAG700MASTERN

BAG700PLUSN

- Set completo di 5 borse professionali con misure differenziate per batteria (rif. tabella). Disponibile in colore nero.
- 5 professional different size drum bag complete set (ref. table). Available in black.

BAG700MASTERN

- Set completo di 5 borse professionali con misure differenziate per batteria (rif. tabella). Disponibile in colore nero.
- 5 professional different size drum bag complete set (ref. table). Available in black.

BAG700ROCKN

- Set completo di 6 borse professionali con misure differenziate per batteria (rif. tabella). Disponibile in colore nero.
- 6 professional different size drum bag complete set (ref. table). Available in black.

DRUM ACCESSORIES BAGS "BAGD" SERIES

BAGS AND STRAPS



BAG610PN



BAG605PN



BAG610PN

BAG510PN



BAG500PN



BAG500PN

- Borsa per piatti con tasca porta bacchette in robusto nylon 420D antistrappo con imbottitura in poliuretano espanso ad alta densità da 10 mm Disponibile in colore nero.
- Heavy duty rip-proof nylon 420D bag, 10mm high density foam padding, for cymbals with sticks pocket. Available in black.

BAG510PN

- Borsa per piatti con tasca porta bacchette e tascone frontale in robusto nylon 420D antistrappo con imbottitura in poliuretano espanso ad alta densità da 10 mm Disponibile in colore nero.
- Heavy duty rip-proof nylon 420D bag, 10mm high density foam padding for cymbals with sticks pocket and wide front pocket. Available in black.

BAG605PN

- Borsa per bacchette in robusto nylon 420D antistrappo con imbottitura in poliuretano espanso ad alta densità da 5 mm. Disponibile nei colori nero.
- Heavy duty rip-proof nylon 420D bag, 5mm high density foam padding, for sticks. Available in black.

BAG610PN

- Borsa per bacchette in robusto nylon 420D antistrappo con imbottitura in poliuretano espanso ad alta densità da 10 mm Disponibile in colore nero.
- Heavy duty rip-proof nylon 420D bag, 10mm high density foam padding, for sticks. Available in black.

GUITAR & SAX STRAPS "BASIC" SERIES

BAGS AND STRAPS



STRAP100BK



STRAP650BK

STRAP100BK

- Tracolla regolabile per chitarra, larghezza 50 mm Colore: nero.
- Adjustable guitar band strap, 50 mm width. Colour: black.

STRAP650BK

- Tracolla estremamente confortevole, con collo interamente imbottito, regolatore scorrevole e moschettone in ABS. Colore: nero.
- Ultra comfortable saxophone band strap, fully foam padded neck piece, fast adjustment slide and ABS snap hooks. Available in black colour.



WOODEN BENCHES

• La linea "Wooden Benches" comprende una gamma di panchette per piano ed organo. I modelli sono disponibili in diverse finiture e colori, per offrire al cliente un'adeguata scelta secondo il proprio gusto e l'oggettiva necessità. Questa linea è interamente costruita in legno di faggio selezionato, e le finiture laccate, sono realizzate in verniciatura poliuretanica elastica con base impregnante nel rispetto dei valori standard (10 gloss per la versione satinata, 90 gloss per la lucida). Il cuscino è realizzato con materiali di prima qualità sia per gli interni (come la gommapiuma per l'imbottitura con densità 35) sia per il rivestimento esterno in similpelle ed in velluto.

- Telaio in legno massello
- Hardware professionale con finitura zincata
- Laccatura con vernici poliuretaniche
- Cuscino rivestito in similpelle o velluto
- Imbottitura in gommapiuma di densità 35

• Proel "Wooden Benches" line is a series of products designed and manufactured to fulfill all market requirements, and includes a varied range of benches for piano and organ. Models are available in different finishes and colours to provide the customer with an adequate choice according to his own taste and necessity. This line is built with wood of selected beech satinated-lacquered finished and elastic polyurethane painting with a saturated base according to standard estimations (10 gloss for the satinized version, 90 gloss for the lacquered one). The cushion is made of high quality materials with foam rubber interior, 35 density padding, covered with imitation leather and velvet.

- Solid wood frame
- Professional hardware with galvanized finish
- Lacquering with polyurethane paints
- Seat covered with imitation leather or velvet
- 35 denier density foam padding



ADJUSTABLE BENCHES "PB90" SERIES

WOODEN BENCHES

• PANCHE REGOLABILI SERIE PB90S

Panchetta professionale regolabile per piano ed organo, seduta imbottita con rivestimento in similpelle. Hardware professionale con finitura zincata, comode manopole per la regolazione dell'altezza.

• ADJUSTABLE BENCHES PB90S SERIES

Professional height adjustable bench for piano and organ, single padded seat with imitation leather cover. Professional hardware with galvanized finish, comfortable height adjusting knobs.



PB90SBBBK



PB90SSBBK



PB90SBWBR

TECH INFO

| | |
|------------------------|----------------------------------|
| Model: | PB90S |
| Seat size: | 525 mm x 306 mm (20.67 x 12.04") |
| Minimum height: | 460 mm (18.11") |
| Maximum height: | 560 mm (22.04") |
| Weight: | 9.00 kg (19.84 lbs) |
| Master Carton: | 1 pc. |

PB90SBBBK **NEW**

- Telaio nero lucido - Rivestimento in similpelle nera.
- Bright black frame - Black imitation leather cover.

PB90SSBBK **NEW**

- Telaio nero opaco - Rivestimento in similpelle nera.
- Matte black frame - Black imitation leather cover.

PB90SBWBR **NEW**

- Telaio noce lucido - Rivestimento in similpelle marrone.
- Bright walnut frame - Brown imitation leather cover.

ADJUSTABLE BENCHES "PB90" SERIES

WOODEN BENCHES



PB90SSRBK



PB90SSWWH



PB90SBWWH

TECH INFO

| | |
|------------------------|----------------------------------|
| Model: | PB90S |
| Seat size: | 525 mm x 306 mm (20.67 x 12.04") |
| Minimum height: | 460 mm (18.11") |
| Maximum height: | 560 mm (22.04") |
| Weight: | 9.00 kg (19.84 lbs) |
| Master Carton: | 1 pc. |

PB90SSRBK **NEW**

- Telaio pallissandro scuro opaco - Rivestimento in similpelle nera.
- Matte rosewood frame - Black imitation leather cover.

PB90SBWWH **NEW**

- Telaio bianco lucido - Rivestimento in similpelle bianca.
- Bright white frame - White imitation leather cover.

PB90SSWWH **NEW**

- Telaio bianco opaco - Rivestimento in similpelle bianca.
- Matte white frame - White imitation leather cover.

ADJUSTABLE BENCHES "PB90" SERIES

WOODEN BENCHES



• PANCHE REGOLABILI SERIE PB90V

Panchetta professionale regolabile per piano ed organo, seduta imbottita con rivestimento in velluto. Hardware professionale con finitura zincata, comode manopole per la regolazione dell'altezza.

• ADJUSTABLE BENCHES PB90V SERIES

Professional height adjustable bench for piano and organ, single padded seat with velvet cover. Professional hardware with galvanized finish, comfortable height adjusting knobs.



PB90VBBBK



PB90VSBBK



PB90VBWBR

TECH INFO

| | |
|------------------------|----------------------------------|
| Model: | PB90V |
| Seat size: | 525 mm x 306 mm (20.67 x 12.04") |
| Minimum height: | 460 mm (18.11") |
| Maximum height: | 560 mm (22.04") |
| Weight: | 9.00 kg (19.84 lbs) |
| Master Carton: | 1 pc. |

PB90VBBBK **NEW**

- Telaio nero lucido - Rivestimento in velluto nero.
- Bright black frame - Black velvet cover.

PB90VSBBK **NEW**

- Telaio nero opaco - Rivestimento in velluto nero.
- Matte black frame - Black velvet cover.

PB90VBWBR **NEW**

- Telaio noce lucido - Rivestimento in velluto marrone.
- Bright walnut frame - Brown velvet cover.

ADJUSTABLE BENCHES "PB90" SERIES

WOODEN BENCHES



PB90VSRBK



PB90VSWWH



PB90VBWWH

TECH INFO

| | |
|------------------------|----------------------------------|
| Model: | PB90V |
| Seat size: | 525 mm x 306 mm (20.67 x 12.04") |
| Minimum height: | 460 mm (18.11") |
| Maximum height: | 560 mm (22.04") |
| Weight: | 9.00 kg (19.84 lbs) |
| Master Carton: | 1 pc. |

PB90VSRBK **NEW**

- Telaio pallissandro scuro opaco - Rivestimento in velluto nero.
- Matte rosewood frame - Black velvet cover.

PB90VBWWH **NEW**

- Telaio bianco lucido - Rivestimento in velluto bianco.
- Bright white frame - White velvet cover.

PB90VSWWH **NEW**

- Telaio bianco opaco - Rivestimento in velluto bianco.
- Matte white frame - White velvet cover.

ALPHABETICAL INDEX



ALPHABETICAL INDEX

| CODE | PAGE | CODE | PAGE | CODE | PAGE |
|---------------|------|---------------|------|----------|------|
| A | | | | | |
| AC103FS | 228 | ADAT200MXTN05 | 113 | APOP30 | 22 |
| AC103GS | 228 | ADAT200MXTN02 | 114 | APOP35 | 22 |
| AC107 | 228 | ADAT200MXTN03 | 114 | APOP40 | 22 |
| AC110 | 228 | ADAT200MXTN04 | 114 | APOP50 | 22 |
| AC111 | 228 | ADAT200MXTN05 | 114 | APOP65 | 22 |
| AC112 | 228 | ADAT220DN02 | 113 | AT100 | 181 |
| AC113 | 228 | ADAT220DN03 | 113 | AT120 | 181 |
| AC114 | 228 | ADAT220DN04 | 113 | AT120PRO | 183 |
| AC116 | 228 | ADAT220DN05 | 113 | AT128 | 181 |
| AC117 | 228 | ADRK1AZ | 68 | AT128PRO | 183 |
| AC118 | 228 | ADRK1PE | 69 | AT140 | 181 |
| AC121 | 228 | ADRK2AZ | 68 | AT140PRO | 183 |
| AC123Z | 228 | ADRK2CR | 69 | AT148 | 181 |
| AC124 | 228 | ADRK2CRSH | 69 | AT148PRO | 183 |
| AC131 | 228 | ADRK2PE | 69 | AT155 | 181 |
| AC132 | 228 | ADRK3AZ | 68 | AT160 | 181 |
| AC133 | 228 | ADRK3CR | 69 | AT165 | 181 |
| AC134 | 228 | ADRK3CRSH | 69 | AT165PRO | 183 |
| AC139 | 228 | ADRK4CR | 69 | AT170 | 181 |
| AC140 | 228 | ALV130BK | 6 | AT170PRO | 183 |
| AC169A | 228 | AP114 | 20 | AT175PRO | 183 |
| ADAT200FXTN02 | 113 | AP122 | 20 | AT180 | 181 |
| ADAT200FXTN03 | 113 | APM10 | 19 | AT190 | 182 |
| ADAT200FXTN04 | 113 | APM15 | 19 | AT190M | 182 |
| ADAT200FXTN05 | 113 | APM20 | 19 | AT190PRO | 183 |
| ADAT200FXTN02 | 114 | APM215 | 20 | AT210 | 182 |
| ADAT200FXTN03 | 114 | APM225 | 20 | AT215 | 182 |
| ADAT200FXTN04 | 114 | APM25 | 19 | AT230 | 182 |
| ADAT200FXTN05 | 114 | APM30 | 19 | AT230PRO | 183 |
| ADAT200JSTN02 | 113 | APM35B | 19 | AT240 | 182 |
| ADAT200JSTN03 | 113 | APM35S | 19 | AT250 | 182 |
| ADAT200JSTN04 | 113 | APM40 | 20 | AT250PRO | 183 |
| ADAT200JSTN05 | 113 | APM45B | 19 | AT260G | 184 |
| ADAT200JSTP02 | 114 | APM45S | 19 | AT263PRO | 183 |
| ADAT200JSTP03 | 114 | APM47 | 20 | AT265G | 184 |
| ADAT200JSTP04 | 114 | APM50BK | 16 | AT280 | 184 |
| ADAT200JSTP05 | 114 | APM50XLR | 16 | AT280PRO | 183 |
| ADAT200MXTN02 | 113 | APM60BK | 16 | AT290 | 184 |
| ADAT200MXTN03 | 113 | APM65 | 21 | AT295 | 184 |
| ADAT200MXTN04 | 113 | APM72 | 21 | AT300 | 184 |
| | | APM74 | 21 | AT305 | 184 |

ALPHABETICAL INDEX

| CODE | PAGE | CODE | PAGE | CODE | PAGE |
|---------------|------|---------------|------|--------------|------|
| AT310 | 184 | AVCAT5PRO75HH | 115 | BAGD14DSPN | 263 |
| AT320 | 184 | AVCAT6PRO30 | 116 | BAGD14PN | 263 |
| AT330 | 184 | AVCAT6PRO50 | 116 | BAGD14PTN | 263 |
| AT340 | 185 | AVCAT6PRO75 | 116 | BAGD14SPN | 263 |
| AT350DMX | 185 | AVCAT6UPRO30 | 116 | BAGD16PN | 263 |
| AT355DMX | 185 | AVCAT6UPRO50 | 116 | BAGD16PTN | 263 |
| AT500 | 185 | AVCAT6UPRO75 | 116 | BAGD18PN | 264 |
| AT510 | 185 | | | BAGD20PN | 264 |
| AT520 | 185 | | | BAGD22PN | 264 |
| AT530 | 185 | BAG100PN | 253 | BOX1204S | 192 |
| AT615 | 185 | BAG110PN | 253 | BOX1608S | 193 |
| AT625 | 185 | BAG120PN | 254 | BOX2408S | 193 |
| AT635 | 185 | BAG130PN | 254 | BOX3208S | 194 |
| ATV01 | 107 | BAG140PN | 254 | BOX4008S | 194 |
| ATV02 | 107 | BAG150A | 255 | BOX804S | 192 |
| ATV03 | 107 | BAG150B | 255 | BOX8S | 192 |
| ATV04 | 107 | BAG150C | 256 | BOXJ1608S | 193 |
| ATV05 | 107 | BAG150C34 | 256 | BOXJ2408S | 194 |
| ATV06 | 107 | BAG150E | 256 | BRV100LU10BK | 93 |
| ATV07 | 107 | BAG200PN | 257 | BRV100LU3BK | 93 |
| AV090 | 158 | BAG210PN | 257 | BRV100LU3BW | 93 |
| AV185 | 158 | BAG220PN | 258 | BRV100LU3BY | 93 |
| AV185D02 | 160 | BAG230PN | 258 | BRV100LU3TB | 94 |
| AV190 | 159 | BAG240PN | 258 | BRV100LU3TR | 94 |
| AV190D01 | 160 | BAG500PN | 265 | BRV100LU5BK | 93 |
| AV190D02 | 160 | BAG510PN | 265 | BRV100LU5BW | 93 |
| AV190D04 | 160 | BAG605PN | 265 | BRV100LU5BY | 93 |
| AV190D08 | 160 | BAG610PN | 265 | BRV100LU5TB | 94 |
| AV190D12 | 160 | BAG700MASTERN | 264 | BRV100LU5TR | 94 |
| AV195 | 159 | BAG700PLUSN | 264 | BRV100LU6BK | 93 |
| AV195D16 | 160 | BAG700ROCKN | 264 | BRV100LU6BW | 93 |
| AV195D20 | 160 | BAG900PN | 261 | BRV100LU6BY | 93 |
| AV310N | 161 | BAG910PN | 261 | BRV100LU6TB | 94 |
| AV405N | 161 | BAG920PN | 261 | BRV100LU6TR | 94 |
| AV415N | 161 | BAG930PN | 261 | BRV120LU3BK | 93 |
| AV425N | 161 | BAG935PN | 261 | BRV120LU3BW | 93 |
| AVCAT5PRO30 | 115 | BAG938PN | 261 | BRV120LU3BY | 93 |
| AVCAT5PRO30HH | 115 | BAG940PN | 261 | BRV120LU3TB | 94 |
| AVCAT5PRO50 | 115 | BAG966PN | 261 | BRV120LU3TR | 94 |
| AVCAT5PRO50HH | 115 | BAGD10PN | 262 | BRV120LU5BK | 93 |
| AVCAT5PRO75 | 115 | BAGD12PN | 262 | BRV120LU5BW | 93 |
| | | BAGD13PN | 262 | | |

ALPHABETICAL INDEX

| CODE | PAGE | CODE | PAGE | CODE | PAGE |
|--------------|---------|---------------|------|---------------|------|
| CAT6UTPHL005 | 117 | CHL220LU10 | 83 | CHLP185LU3 | 87 |
| CAT6UTPHL01 | 117 | CHL220LU2 | 83 | CHLP190LU10 | 87 |
| CAT6UTPHL02 | 117 | CHL220LU3 | 83 | CHLP190LU3 | 87 |
| CAT6UTPHL03 | 117 | CHL220LU5 | 83 | CHLP190LU5 | 87 |
| CAT6UTPHL05 | 117 | CHL220LU6 | 83 | CHLP210LU15 | 87 |
| CAT6UTPHL10 | 117 | CHL230LU1 | 84 | CHLP210LU3 | 87 |
| CAT6UTPHL15 | 117 | CHL230LU10 | 84 | CHLP210LU5 | 87 |
| CAT6UTPHL20 | 117 | CHL230LU2 | 84 | CHLP215LU15 | 87 |
| CBX15030 | 193/194 | CHL230LU3 | 84 | CHLP215LU15XL | 87 |
| CBX15030X | 194 | CHL230LU5 | 84 | CHLP215LU3 | 87 |
| CBX15030XL | 194 | CHL250LU05 | 84 | CHLP215LU3XL | 87 |
| CBX15050 | 193/194 | CHL250LU1 | 84 | CHLP215LU5 | 87 |
| CBX15050X | 194 | CHL250LU10 | 84 | CHLP215LU5XL | 87 |
| CBX15050XL | 194 | CHL250LU15 | 84 | CHLP220LU15 | 88 |
| CBX8520 | 193 | CHL250LU2 | 84 | CHLP220LU3 | 88 |
| CBX8530 | 193 | CHL250LU20 | 84 | CHLP250LU15 | 88 |
| CHL100LU1 | 83 | CHL250LU3 | 84 | CHLP250LU3 | 88 |
| CHL100LU10 | 83 | CHL250LU5 | 84 | CHLP260LU15 | 88 |
| CHL100LU2 | 83 | CHL250LU6 | 84 | CHLP260LU3 | 88 |
| CHL100LU3 | 83 | CHL400LU15 | 85 | CHLP260LU5 | 88 |
| CHL100LU5 | 83 | CHL400LU3 | 85 | CHLP270LU15 | 88 |
| CHL100LU6 | 83 | CHL400LU5 | 85 | CHLP270LU3 | 88 |
| CHL120LU1 | 83 | CHL500LU10 | 85 | CHLP280LU15 | 88 |
| CHL120LU3 | 83 | CHL500LU2 | 85 | CHLP280LU3 | 88 |
| CHL120LU5 | 83 | CHL500LU3 | 85 | CHLP290LU10 | 89 |
| CHL120LU6 | 83 | CHL500LU5 | 85 | CHLP290LU15 | 89 |
| CHL140LU1 | 84 | CHLP115LU015 | 86 | CHLP290LU3 | 89 |
| CHL140LU10 | 84 | CHLP115LU03 | 86 | CHLP290LU5 | 89 |
| CHL140LU2 | 84 | CHLP115LU06 | 86 | CHLP300LU3 | 89 |
| CHL140LU3 | 84 | CHLP170LU15 | 86 | CHLP310LU15 | 89 |
| CHL140LU5 | 84 | CHLP170LU15XL | 86 | CHLP310LU3 | 89 |
| CHL140LU6 | 84 | CHLP170LU3 | 86 | CHLP310LU5 | 89 |
| CHL200LU10 | 83 | CHLP170LU3XL | 86 | CHLP315LU15 | 89 |
| CHL200LU3 | 83 | CHLP170LU5 | 86 | CHLP315LU3 | 89 |
| CHL200LU5 | 83 | CHLP170LU5XL | 86 | CHLP315LU5 | 89 |
| CHL200LU6 | 83 | CHLP175LU15 | 86 | CHLP320LU03 | 89 |
| CHL210LU1 | 84 | CHLP175LU3 | 86 | CHLP320LU15 | 89 |
| CHL210LU2 | 84 | CHLP180LU10 | 86 | CHLP320LU3 | 89 |
| CHL210LU3 | 84 | CHLP180LU3 | 86 | CHLP325LU03 | 90 |
| CHL210LU5 | 84 | CHLP180LU5 | 86 | CHLP325LU15 | 90 |
| CHL220LU1 | 83 | CHLP185LU15 | 87 | CHLP325LU3 | 90 |

ALPHABETICAL INDEX

| CODE | PAGE | CODE | PAGE | CODE | PAGE |
|--------------|------|------------|------|------------|------|
| CHLP330LU15 | 90 | CMN24 | 129 | CR412BLKMW | 221 |
| CHLP330LU3 | 90 | CMN32 | 129 | CR416BLKMW | 221 |
| CHLP335LU015 | 90 | CMN40 | 129 | CR418BLKMW | 221 |
| CHLP340LU015 | 90 | CMN48 | 129 | CSG2510 | 192 |
| CHLP430LU4 | 91 | CMN8 | 129 | CSG2520 | 192 |
| CMD02 | 126 | CMT12 | 127 | CSG3710 | 192 |
| CMD04 | 126 | CMT16 | 127 | CSG3720 | 192 |
| CMD08 | 126 | CMT2 | 127 | CSG5420 | 192 |
| CMI12 | 128 | CMT24 | 127 | CSG5430 | 192 |
| CMI16 | 128 | CMT32 | 127 | CSOX19FP | 216 |
| CMI24 | 128 | CMT4 | 127 | CSOX19FV | 216 |
| CMI32 | 128 | CMT40 | 127 | CSOX19MP | 216 |
| CMI4 | 128 | CMT48 | 127 | CSOX19MV | 216 |
| CMI8 | 128 | CMT8 | 127 | CV15030 | 196 |
| CMIL150FP | 200 | CR102BLKM | 219 | CV15030X | 196 |
| CMIL150FV | 200 | CR103BLKM | 219 | CV15030XL | 197 |
| CMIL150MP | 200 | CR104BLKM | 219 | CV15050 | 196 |
| CMIL150MV | 200 | CR105BLKM | 219 | CV15050X | 196 |
| CMIL19FP | 198 | CR106BLKM | 219 | CV15050XL | 197 |
| CMIL19FV | 198 | CR108BLKM | 219 | CV8530X | 196 |
| CMIL19MP | 198 | CR122BLKM | 219 | CV8550X | 196 |
| CMIL19MV | 198 | CR123BLKM | 219 | CVDMX101 | 100 |
| CMIL25FP | 198 | CR124BLKM | 219 | CVDMX102 | 100 |
| CMIL25FV | 199 | CR126BLKM | 219 | CVDMX103 | 100 |
| CMIL25MP | 199 | CR152BLKM | 220 | CVDMX105 | 100 |
| CMIL25MV | 198 | CR153BLKM | 220 | CVDMX110 | 100 |
| CMIL37FP | 199 | CR154BLKM | 220 | CVDMX115 | 100 |
| CMIL37FV | 199 | CR156BLKM | 220 | CVDMX120 | 100 |
| CMIL37MP | 199 | CR202BLKM | 220 | CVDMX125 | 100 |
| CMIL37MV | 199 | CR203BLKM | 220 | CVDMX1N015 | 81 |
| CMIL54FP | 199 | CR204BLKM | 220 | CVDMX1N03 | 81 |
| CMIL54FV | 199 | CR205BLKM | 220 | CVDMX1N05 | 81 |
| CMIL54MP | 199 | CR206BLKM | 220 | CVDMX1N10 | 81 |
| CMIL54MV | 199 | CR208BLKM | 220 | CVDMX1N15 | 81 |
| CMIL85FP | 200 | CR210BLKM | 220 | CVDMX1N20 | 81 |
| CMIL85FV | 200 | CR210BLKMW | 221 | CVDMX201 | 100 |
| CMIL85MP | 200 | CR212BLKMW | 221 | CVDMX202 | 100 |
| CMIL85MV | 200 | CR216BLKMW | 221 | CVDMX203 | 100 |
| CMN12 | 129 | CR218BLKMW | 221 | CVDMX205 | 100 |
| CMN16 | 129 | CR224BLKMW | 221 | CVDMX210 | 100 |
| CMN20 | 129 | CR410BLKMW | 221 | CVDMX215 | 100 |

ALPHABETICAL INDEX

| CODE | PAGE | CODE | PAGE | CODE | PAGE |
|-------------|------|--------------|------|--------------|------|
| CVDMX220 | 100 | DST140BK | 18 | ESO1000LU2 | 80 |
| CVDMX225 | 100 | DST150BK | 18 | ESO1000LU20 | 80 |
| CVDMX2N015 | 81 | DST260 | 17 | ESO1000LU5 | 80 |
| CVDMX2N03 | 81 | DST40TL | 17 | ESO100LU10 | 75 |
| CVDMX2N05 | 81 | DST60TL | 17 | ESO100LU3 | 75 |
| CVDMX2N10 | 81 | | | ESO100LU5 | 75 |
| CVDMX2N15 | 81 | E | | ESO100LU6 | 75 |
| CVDMX2N20 | 81 | EBN1204 | 188 | ESO120LU3 | 75 |
| CVS0601F | 214 | EBN1604 | 188 | ESO120LU5 | 75 |
| CVS0601M | 214 | EBN2408 | 188 | ESO120LU6 | 75 |
| CVSOX05 | 214 | EBN2408LU50 | 188 | ESO130LU1 | 75 |
| CVSOX10 | 214 | EBN3208 | 188 | ESO130LU10 | 75 |
| CVSOX15 | 214 | EBN3208LU50 | 188 | ESO130LU3 | 75 |
| CVSOX20 | 214 | EBN8 | 188 | ESO130LU5 | 75 |
| CVSOX25 | 214 | EBN804 | 188 | ESO130LU6 | 75 |
| CVSOX30 | 214 | EBN804LU10 | 188 | ESO135LU1 | 75 |
| CVSOX40 | 214 | EBN8LU10 | 188 | ESO135LU10 | 75 |
| CWCAG | 247 | EL100 | 26 | ESO135LU3 | 75 |
| CWCAGX | 250 | EL250 | 26 | ESO135LU5 | 75 |
| CWCCG | 247 | EL260 | 27 | ESO135LU6 | 75 |
| CWCCGX | 250 | EL270 | 27 | ESO145LU3 | 75 |
| CWCEBR | 248 | EL280 | 28 | ESO145LU5 | 75 |
| CWCEBRX | 251 | EL290 | 28 | ESO145LU6 | 75 |
| CWCEBT | 249 | EL30 | 39 | ESO1500LU10 | 80 |
| CWCEGR | 248 | EL450 | 29 | ESO1500LU15 | 80 |
| CWCEGRX | 251 | EL50 | 39 | ESO1500LU20 | 80 |
| CWCEGT | 249 | EL55 | 39 | ESO1500LU5 | 80 |
| | | EL620 | 35 | ESO2000LU10 | 80 |
| D | | EL680 | 35 | ESO2000LU15 | 80 |
| DJCTRLC1S | 227 | EL700 | 35 | ESO2000LU2 | 80 |
| DJCTRLC2M | 227 | EL80 | 25 | ESO2000LU20 | 80 |
| DJCTRLC3L | 227 | EL80D | 25 | ESO210LU05 | 77 |
| DJCTRLC5XXL | 227 | ELBOX55125AP | 209 | ESO210LU1 | 77 |
| DMXD | 144 | ELBOX5532 | 207 | ESO210LU10 | 77 |
| DMXD1 | 145 | ELBOX5563 | 208 | ESO210LU10WH | 77 |
| DMXDBL | 144 | ELBOX5563AP | 209 | ESO210LU15 | 77 |
| DMXDD | 145 | ELBOX6563 | 208 | ESO210LU20 | 77 |
| DMXDR500 | 144 | ELBOXRES | 209 | ESO210LU3 | 77 |
| DST100 | 16 | ELPIANO | 29 | ESO210LU3WH | 77 |
| DST110 | 16 | ESO1000LU1 | 80 | ESO210LU5 | 77 |
| DST110BK | 16 | ESO1000LU10 | 80 | ESO210LU5WH | 77 |
| DST130BK | 18 | ESO1000LU15 | 80 | | |

ALPHABETICAL INDEX

| CODE | PAGE | CODE | PAGE | CODE | PAGE |
|-------------|------|-------------|------|------------|---------|
| ES0210LU6 | 77 | ES02500LU05 | 81 | ES0290LU15 | 78 |
| ES0210LU6WH | 77 | ES02500LU1 | 81 | ES0290LU2 | 78 |
| ES0210R050 | 79 | ES02500LU10 | 81 | ES0290LU20 | 78 |
| ES0210R075 | 79 | ES02500LU15 | 81 | ES0290LU3 | 78 |
| ES0210R100 | 79 | ES02500LU2 | 81 | ES0290LU5 | 78 |
| ES0215LU01G | 77 | ES02500LU5 | 81 | ES0290LU6 | 78 |
| ES0215LU02G | 77 | ES0250LU10 | 76 | ES0290R050 | 79 |
| ES0215LU03G | 77 | ES0250LU3 | 76 | ES0290R075 | 79 |
| ES0215LU05G | 77 | ES0250LU5 | 76 | ES0290R100 | 79 |
| ES0215LU06G | 77 | ES0255LU05 | 78 | ES0295LU10 | 79 |
| ES0215LU10G | 77 | ES0255LU1 | 78 | ES0295LU15 | 79 |
| ES0215LU15G | 77 | ES0255LU10 | 78 | ES0295LU20 | 79 |
| ES0215LU20G | 77 | ES0255LU15 | 78 | ES0295LU5 | 79 |
| ES0215LU30G | 77 | ES0255LU2 | 78 | ES0295LU6 | 79 |
| ES0225LU05 | 77 | ES0255LU20 | 78 | ES0500LU10 | 80 |
| ES0225LU1 | 77 | ES0255LU3 | 78 | ES0500LU15 | 80 |
| ES0225LU10 | 77 | ES0255LU5 | 78 | ES0500LU2 | 80 |
| ES0225LU15 | 77 | ES0255LU6 | 78 | ES0500LU20 | 80 |
| ES0225LU2 | 77 | ES02700LU10 | 81 | ES0800LU1 | 80 |
| ES0225LU20 | 77 | ES02700LU20 | 81 | ES0800LU10 | 80 |
| ES0225LU3 | 77 | ES0280LU1 | 78 | ES0800LU15 | 80 |
| ES0225LU5 | 77 | ES0280LU10 | 78 | ES0800LU2 | 80 |
| ES0225LU6 | 77 | ES0280LU15 | 78 | ES0800LU20 | 80 |
| ES0230LU05 | 76 | ES0280LU2 | 78 | ES0800LU5 | 80 |
| ES0230LU1 | 76 | ES0280LU20 | 78 | EZBOX1204 | 187 |
| ES0230LU10 | 76 | ES0280LU3 | 78 | EZBOX1604 | 187 |
| ES0230LU2 | 76 | ES0280LU5 | 78 | | |
| ES0230LU3 | 76 | ES0280LU6 | 78 | F | |
| ES0230LU5 | 76 | ES0280R050 | 79 | FBX1204 | 192 |
| ES0235LU10 | 76 | ES0280R075 | 79 | FBX1608 | 193 |
| ES0235LU3 | 76 | ES0280R100 | 79 | FBX2408 | 193/194 |
| ES0235LU5 | 76 | ES0285LU1 | 78 | FBX3208 | 194 |
| ES0240LU1 | 76 | ES0285LU10 | 78 | FBX4008 | 194 |
| ES0240LU10 | 76 | ES0285LU15 | 78 | FBX8 | 192 |
| ES0240LU2 | 76 | ES0285LU2 | 78 | FBX804 | 192 |
| ES0240LU3 | 76 | ES0285LU20 | 78 | FC100 | 30 |
| ES0240LU5 | 76 | ES0285LU3 | 78 | FC200 | 30 |
| ES0245LU1 | 76 | ES0285LU5 | 78 | FC510 | 33 |
| ES0245LU10 | 76 | ES0285LU6 | 78 | FC520 | 33 |
| ES0245LU3 | 76 | ES0290LU1 | 78 | FC600 | 33 |
| ES0245LU5 | 76 | ES0290LU10 | 78 | FC705 | 30 |
| | | | | FC720 | 31 |

ALPHABETICAL INDEX

| CODE | PAGE | CODE | PAGE | CODE | PAGE |
|------------|------|--------------|------|--------------|------|
| FC80 | 30 | FRCA20WH | 180 | HPC210PU | 139 |
| FC820 | 31 | FRE180BKV2 | 49 | HPC210RD | 139 |
| FC830N | 32 | FRE180KITV2 | 49 | HPC210WH | 139 |
| FC850N | 32 | FRE300BK | 49 | HPC210YE | 139 |
| FC870N | 32 | FRE300KIT | 49 | HPC222BK | 139 |
| FCRB200 | 222 | FSR2260 | 64 | HPC250 | 138 |
| FCRB400 | 222 | FSR2760 | 64 | HPC280 | 138 |
| FCRBSA | 222 | FSR3260 | 64 | HPC290BK | 137 |
| FOABSAGC | 245 | FSR3760 | 64 | HPC300 | 135 |
| FOABSCGC | 245 | FSR4260 | 64 | HPC3015FG | 157 |
| FOABSEBC | 245 | FSRSHELF02 | 64 | HPC3025FG | 157 |
| FOABSEGC | 245 | | | HPC305 | 135 |
| FOABSMIC12 | 244 | G | | HPC501 | 142 |
| FOABSMIC9 | 244 | GF01 | 204 | HPC502 | 142 |
| FOABSMIX12 | 244 | GF12 | 202 | HPC610BK | 152 |
| FOABSR10U | 242 | GF12L | 203 | HPC610BKR300 | 152 |
| FOABSR10UW | 243 | GF14 | 202 | HPC610FT | 154 |
| FOABSR12U | 242 | GF14L | 203 | HPC610HF | 154 |
| FOABSR2U | 241 | GF16L | 203 | HPC620BK | 152 |
| FOABSR2UM | 240 | GF20 | 205 | HPC620BKR300 | 152 |
| FOABSR2US | 239 | GF22 | 205 | HPC620FT | 154 |
| FOABSR3U | 241 | GF24 | 205 | HPC620HF | 154 |
| FOABSR3UM | 240 | GF26 | 205 | HPC624BK | 152 |
| FOABSR3US | 239 | GF28 | 204 | HPC624FT | 154 |
| FOABSR4U | 241 | GF29 | 204 | HPC624HF | 154 |
| FOABSR4UM | 240 | H | | HPC640BK | 152 |
| FOABSR4US | 239 | HPC110BK | 134 | HPC644 | 152 |
| FOABSR6U | 241 | HPC110BL | 134 | HPC660BK | 153 |
| FOABSR6UM | 240 | HPC110RD | 134 | HPC685BK | 153 |
| FOABSR6US | 239 | HPC130 | 134 | HPC700 | 155 |
| FOABSR6UW | 243 | HPC1925FGN | 157 | HPC710 | 155 |
| FOABSR8U | 242 | HPC201BK | 140 | HPC752RN | 155 |
| FOABSR8UM | 240 | HPC210BK | 139 | HPC754RN | 155 |
| FOABSR8UW | 243 | HPC210BKR300 | 139 | HPC756RN | 155 |
| FOAGBAG | 259 | HPC210BKR500 | 139 | HPC80 | 141 |
| FOCGBAG | 260 | HPC210BL | 139 | HPC805 | 131 |
| FOEBBAG | 259 | HPC210BZ | 139 | HPC80R300 | 141 |
| FOEGBAG | 260 | HPC210FR | 140 | HPC80R500 | 141 |
| FRCA10BK | 180 | HPC210FR300 | 140 | HPC80WH | 141 |
| FRCA10RD | 180 | HPC210GN | 139 | HPC80WHR300 | 141 |
| FRCA20RD | 180 | HPC210HF | 141 | HPC820 | 131 |
| | | HPC210HFR300 | 141 | | |

ALPHABETICAL INDEX

| CODE | PAGE | CODE | PAGE | CODE | PAGE |
|-----------|--------|--------------|---------|-----------|------|
| HPC85 | 132 | LTS007C | 41 | NE8FDP | 167 |
| HPC860HF | 132 | M | | NE8FDV | 167 |
| HPC90 | 142 | MRC A20BK | 180 | NE8FDXY6 | 167 |
| HPC90R300 | 142 | MRC A20RD | 180 | NE8FDXY6B | 167 |
| K | | MRC A25BK | 180 | NE8FF | 167 |
| KB400 | 29 | MRC A25RD | 180 | NE8MX | 167 |
| KGST10 | 39 | MRC A30BK | 180 | NE8MX1 | 167 |
| KIT12 | 70/229 | MRC A30RD | 180 | NE8MX6BT | 167 |
| KIT12B | 70/229 | MRC A35BK | 180 | NE8MX6T | 167 |
| KITLHST | 58 | MRC A35RD | 180 | NE8MXB | 167 |
| KP120 | 59 | MRC A48BK | 180 | NE8MXB1 | 167 |
| KP135 | 59 | MRC A48RD | 180 | NL2FX | 169 |
| KP210 | 51 | MRC A50BK | 180 | NL2MP | 170 |
| KP210S | 51 | MRC A50RD | 180 | NL4FC | 169 |
| KP225 | 51 | M SLL06 | 45 | NL4FX | 169 |
| KP305N | 51 | M SLL18 | 45 | NL4MMX | 170 |
| KP560 | 52 | N | | NL4MP | 170 |
| KP560WH | 52 | NAC3FCA | 170/216 | NL8FC | 169 |
| KP565 | 52 | NAC3FCB | 170/216 | NL8MPR | 170 |
| KP565WH | 52 | NAC3FPXSTTOP | 171 | NP2C | 165 |
| KP570 | 52 | NAC3FPXTOP | 171 | NP2RX | 165 |
| KP595 | 52 | NAC3FXWTOP | 171 | NP2RXAU | 165 |
| KP810D | 36 | NAC3MPA | 170/216 | NP2RXBAG | 165 |
| KP820 | 37 | NAC3MPB | 170/216 | NP2X | 165 |
| KP840 | 36 | NAC3MPXTOP | 171 | NP2XAU | 165 |
| KP845 | 36 | NAC3MXWTOP | 171 | NP2XB | 165 |
| KP875 | 37 | NAC3PXTOP | 171 | NP2XBAG | 165 |
| KR08 | 61 | NC3FDLX | 169 | NP3C | 165 |
| KR21PRO | 61 | NC3FRX | 168 | NP3X | 165 |
| KS300 | 34 | NC3FXX | 168 | NP3XB | 165 |
| KS350 | 34 | NC3FXXB | 168 | NP3XBAG | 165 |
| L | | NC3FXXBAG | 168 | NTP3RC | 165 |
| LAN52SPW | 147 | NC3MDLX | 169 | NYS231 | 166 |
| LAN5S | 149 | NC3MRX | 169 | NYS231BG | 166 |
| LAN61S | 147 | NC3MXX | 168 | NYS240 | 166 |
| LAN62S | 148 | NC3MXXB | 168 | NYS240BG | 166 |
| LAN64 | 150 | NC3MXXBAG | 168 | NYS3730 | 166 |
| LAN6S | 149 | NC5FDLX | 169 | NYS3732 | 166 |
| LAN6UTP | 150 | NC5FXX | 168 | O | |
| LTS001 | 41 | NC5MDLX | 169 | OST110BK | 6 |
| LTS004PRO | 41 | NC5MXX | 168 | OST200BK | 6 |

ALPHABETICAL INDEX

| CODE | PAGE | CODE | PAGE | CODE | PAGE |
|---------------|------|-------------|---------|---------------|------|
| P | | | | | |
| P130 | 176 | PBSL08NXX03 | 111 | PH140LU2 | 109 |
| P220 | 176 | PBSL08NXX04 | 111 | PH140LU5 | 109 |
| P230 | 176 | PBSL08NXX05 | 111 | PH145LU02DMX | 110 |
| P2C | 176 | PBSL08NXX10 | 111 | PH145LU03DMX | 110 |
| PB90SBBBK | 268 | PBSL08PXX03 | 112 | PH145LU04DMX | 110 |
| PB90SBWBR | 268 | PBSL08PXX04 | 112 | PH145LU052DMX | 110 |
| PB90SBWWH | 268 | PBSL08PXX05 | 112 | PH145LU10 | 109 |
| PB90SSBBK | 268 | PBSL08PXX10 | 112 | PH145LU15 | 109 |
| PB90SSRBK | 268 | PBX15030 | 193/194 | PH145LU20 | 109 |
| PB90SSWWH | 268 | PBX15030X | 194 | PH150LU025 | 109 |
| PB90VBBBK | 270 | PBX15030XL | 194/197 | PH150LU05 | 109 |
| PB90VBWBR | 270 | PBX15050 | 193/194 | PH150LU10 | 109 |
| PB90VBWWH | 268 | PBX15050X | 194 | PH155LU02DMX | 110 |
| PB90VSBBK | 270 | PBX15050XL | 194/197 | PH155LU03DMX | 110 |
| PB90VSRBK | 268 | PBX2510 | 192 | PH155LU04DMX | 110 |
| PB90VSWWH | 268 | PBX2520 | 192 | PH155LU052DMX | 110 |
| PBSL04NJSJS03 | 111 | PBX3710 | 192 | PL8545 | 57 |
| PBSL04NJSJS04 | 111 | PBX3720 | 192 | PLADT01 | 59 |
| PBSL04NJSJS05 | 111 | PBX5420 | 192 | PLH420 | 59 |
| PBSL04NJSJS10 | 111 | PBX5430 | 192 | PLH508 | 57 |
| PBSL04NXX03 | 111 | PBX8520 | 193 | PLH565LF | 57 |
| PBSL04NXX04 | 111 | PBX8530 | 193 | PLH582 | 57 |
| PBSL04NXX05 | 111 | PFOAM10 | 236 | PLH583 | 57 |
| PBSL04NXX10 | 111 | PFOAM20 | 236 | PLH584 | 57 |
| PBSL04PXX03 | 112 | PFOAM30 | 237 | PLH585 | 57 |
| PBSL04PXX04 | 112 | PFOAM40 | 237 | PLHST10 | 58 |
| PBSL04PXX05 | 112 | PH080LU05 | 108 | PLKP182FL | 59 |
| PBSL04PXX10 | 112 | PH080LU10 | 108 | PLSPN01 | 59 |
| PBSL08NJSJS03 | 111 | PH080LU15 | 108 | PLWIN530 | 56 |
| PBSL08NJSJS04 | 111 | PH080LU20 | 108 | PLWIN540PRO | 54 |
| PBSL08NJSJS05 | 111 | PH100LU10 | 108 | PLWIN610 | 55 |
| PBSL08NJSJS10 | 111 | PH100LU15 | 108 | PLWIN650PRO | 53 |
| PBSL08NJSXF03 | 112 | PH100LU20 | 108 | PP2C | 176 |
| PBSL08NJSXF04 | 112 | PH100LU5 | 108 | PP300 | 176 |
| PBSL08NJSXF05 | 112 | PH130LU10 | 108 | PP310 | 176 |
| PBSL08NJSXF10 | 112 | PH130LU15 | 108 | PPCASE04 | 231 |
| PBSL08NJSXM03 | 112 | PH130LU20 | 108 | PPCASE05 | 231 |
| PBSL08NJSXM04 | 112 | PH135LU10 | 109 | PPCASE06 | 231 |
| PBSL08NJSXM05 | 112 | PH135LU15 | 109 | PPCASE07 | 232 |
| PBSL08NJSXM10 | 112 | PH135LU20 | 109 | PPCASE08 | 232 |
| | | PH140LU10 | 109 | PPCASE09 | 233 |

ALPHABETICAL INDEX

| CODE | PAGE | CODE | PAGE | CODE | PAGE |
|------------|------|------------|------|-----------|------|
| PPCASE12W | 233 | PRVGA200 | 106 | RSM295 | 42 |
| PPCASE13W | 234 | PRVGA250 | 106 | RSM300 | 42 |
| PPCASE14W | 234 | PRVGA300 | 106 | RSM360M | 44 |
| PR15030 | 196 | PSE3 | 5 | RSM360WOB | 44 |
| PR15030X | 196 | PXCOVER08N | 63 | RSM365M | 44 |
| PR15050 | 196 | PXCOVER12N | 63 | RSM430N | 45 |
| PR15050X | 196 | PXCOVER18N | 63 | RSM445 | 15 |
| PR8530X | 196 | PXCOVER24N | 63 | RSM600 | 43 |
| PR8550X | 196 | Q | | RSM650 | 43 |
| PRCA25BK | 180 | QUAD420 | 137 | RSM700 | 43 |
| PRCA25RD | 180 | R | | S | |
| PRHDMI018 | 106 | RK12N | 67 | S120 | 176 |
| PRHDMI030 | 106 | RK16N | 67 | S130 | 176 |
| PRHDMI050 | 106 | RK1L | 66 | S150 | 176 |
| PRHDMI100 | 106 | RK1MG | 67 | S210 | 172 |
| PRHDMI150 | 106 | RK1NV | 66 | S210BK | 172 |
| PRHDMI200 | 106 | RK1PX | 67 | S215 | 174 |
| PRMSBAG | 8 | RK2L | 66 | S215BK | 174 |
| PRMSBAG01 | 14 | RK2MG | 67 | S220 | 175 |
| PRO100BK | 7 | RK2NV | 66 | S230 | 172 |
| PRO100CR | 7 | RK2VP | 68 | S230S | 174 |
| PRO110BK | 7 | RK3L | 66 | S232 | 172 |
| PRO165BK | 14 | RK4L | 66 | S232S | 174 |
| PRO200BK | 8 | RK4N | 67 | S240 | 175 |
| PRO200BKFF | 8 | RK6N | 67 | S240S | 175 |
| PRO200CR | 8 | RK6VP | 68 | S242 | 175 |
| PRO281BK | 8 | RK8N | 67 | S242S | 175 |
| PRO300BK | 9 | RK8VP | 68 | S290BK | 172 |
| PRO400BK | 9 | RSM100BK | 10 | S295BK | 174 |
| PROIPS03 | 15 | RSM170 | 13 | S2C | 172 |
| PROIPS04 | 15 | RSM180 | 13 | S2CBK | 172 |
| PROKARTM | 60 | RSM181 | 13 | S2CPROBK | 173 |
| PROKARTXL | 60 | RSM192BK | 11 | S2CPROBL | 173 |
| PRORF02 | 22 | RSM195BK | 11 | S2CPRON | 173 |
| PRPH40S | 38 | RSM197BK | 12 | S2CPRORD | 173 |
| PRPH50L | 38 | RSM198BK | 12 | S2RCS | 175 |
| PRSSBAG01 | 50 | RSM200BK | 10 | S320 | 172 |
| PRSSBAG02 | 50 | RSM210 | 14 | S320S | 174 |
| PRVGA050 | 106 | RSM225 | 14 | S3C | 174 |
| PRVGA100 | 106 | RSM230 | 14 | S3CBK | 174 |
| PRVGA150 | 106 | RSM240 | 14 | S3CPROBK | 174 |

ALPHABETICAL INDEX

| CODE | PAGE | CODE | PAGE | CODE | PAGE |
|-------------|------|-------------|---------|--------------|------|
| S3CPRON | 174 | SDC780LU015 | 212 | SNBOX32 | 196 |
| S400 | 172 | SDC780LU025 | 212 | SNBOX40 | 197 |
| S4CPRO | 173 | SDC780LU05 | 212 | SPB30 | 118 |
| S4RCS | 175 | SDC780LU10 | 212 | SPB60 | 118 |
| S500 | 172 | SDC785LU015 | 212 | SPL100 | 23 |
| S5CPRO | 174 | SDC785LU025 | 212 | SPL150 | 23 |
| SA04BLKM | 222 | SDC785LU05 | 212 | SPL152 | 24 |
| SA06BLKM | 222 | SDC785LU10 | 212 | SPL250 | 23 |
| SA08BLKM | 222 | SDC790LU015 | 213 | SPL252 | 24 |
| SA10BLKM | 222 | SDC790LU025 | 213 | SPL253 | 24 |
| SA12BLKM | 223 | SDC790LU05 | 213 | SPLIT16 | 195 |
| SA16BLKM | 223 | SDC790LU10 | 213 | SPLIT24 | 195 |
| SA18BLKM | 223 | SDC795LU015 | 213 | SPLIT32 | 195 |
| SA20BLKM | 223 | SDC795LU025 | 213 | SPLIT40 | 195 |
| SA26BLK | 224 | SDC795LU05 | 213 | SPSK105BKF5 | 48 |
| SA31BLKM | 223 | SDC795LU10 | 213 | SPSK290BK | 48 |
| SA32BLKM | 223 | SDC840 | 215 | SPSK300AL | 47 |
| SCNACFPX | 171 | SDC840BK | 215 | SPSK300BAG | 50 |
| SCNACMPX | 171 | SDC843BK | 215 | SPSK300BK | 47 |
| SCNACPX | 171 | SDC844 | 215 | SPSK300KIT | 47 |
| SD73PRODJ | 226 | SDC852BK | 215 | SPSK310BK | 48 |
| SD82PRODJ | 226 | SDC853 | 215 | SSCOVBK | 50 |
| SDC130 | 211 | SDC863GS | 215 | SSCOVWH | 50 |
| SDC130BK | 211 | SDC864GS | 215 | STAGE100 | 97 |
| SDC2PV | 215 | SGB140 | 40 | STAGE100LU05 | 97 |
| SDC308R | 211 | SGB145 | 40 | STAGE100LU1 | 97 |
| SDC3232 | 210 | SGB155 | 40 | STAGE100LU15 | 97 |
| SDC350 | 210 | SGB85BK | 40 | STAGE100LU2 | 97 |
| SDC360 | 210 | SL04DRW | 224 | STAGE100LU20 | 97 |
| SDC460 | 211 | SL05BLK | 225 | STAGE100LU3 | 97 |
| SDC465 | 211 | SL10BLKW | 225 | STAGE100LU6 | 97 |
| SDC470 | 211 | SL15BLKW | 225 | STAGE110 | 97 |
| SDC660PRO | 46 | SL20BLKW | 225 | STAGE180LU1 | 97 |
| SDC665PRO | 46 | SL25BLKW | 225 | STAGE180LU10 | 97 |
| SDC665RAPRO | 46 | SM200LU25 | 118/212 | STAGE180LU15 | 97 |
| SDC670PRO | 46 | SM300LU10 | 118/212 | STAGE180LU2 | 97 |
| SDC775LU007 | 212 | SM300LU15 | 118/212 | STAGE180LU20 | 97 |
| SDC775LU015 | 212 | SM300LU25 | 118/212 | STAGE180LU3 | 97 |
| SDC775LU025 | 212 | SM300LU5 | 118/212 | STAGE180LU5 | 97 |
| SDC775LU05 | 212 | SNBOX16 | 196 | STAGE180LU6 | 97 |
| SDC775LU10 | 212 | SNBOX24 | 196 | STAGE185LU3 | 97 |

ALPHABETICAL INDEX

| CODE | PAGE | CODE | PAGE | CODE | PAGE |
|--------------|------|--------------|------|-------------|------|
| STAGE185LU5 | 97 | STAGE340LU10 | 99 | TPF19 | 198 |
| STAGE275LU1 | 98 | STAGE340LU2 | 99 | TPF25 | 199 |
| STAGE275LU10 | 98 | STAGE340LU3 | 99 | TPF37 | 199 |
| STAGE275LU15 | 98 | STAGE340LU5 | 99 | TPF54 | 199 |
| STAGE275LU2 | 98 | STAGE690LU1 | 99 | TPF85 | 200 |
| STAGE275LU20 | 98 | STAGE690LU10 | 99 | TPM19 | 198 |
| STAGE275LU3 | 98 | STAGE690LU2 | 99 | TPM25 | 198 |
| STAGE275LU5 | 98 | STAGE690LU3 | 99 | TPM37 | 199 |
| STAGE275LU6 | 98 | STAGE690LU5 | 99 | TPM54 | 199 |
| STAGE280LU05 | 98 | STR1606 | 196 | TPM85 | 200 |
| STAGE280LU1 | 98 | STR2408 | 196 | W | |
| STAGE280LU10 | 98 | STR3208 | 196 | WMRC6606 | 65 |
| STAGE280LU15 | 98 | STR4008 | 197 | WMRC6609 | 65 |
| STAGE280LU2 | 98 | STRAP100BK | 266 | WMRC6612 | 65 |
| STAGE280LU20 | 98 | STRAP650BK | 266 | WMRCD6506 | 65 |
| STAGE280LU3 | 98 | STUDIORK08 | 63 | WMRCD6509 | 65 |
| STAGE280LU5 | 98 | STUDIORK12 | 63 | WMRCD6512 | 65 |
| STAGE280LU6 | 98 | STUDIORK18 | 63 | WRAPIT | 119 |
| STAGE290LU1 | 98 | STUDIORK24 | 63 | WS1BK | 21 |
| STAGE290LU10 | 98 | T | | WS2BK | 21 |
| STAGE290LU2 | 98 | TIE1012 | 119 | WS6 | 21 |
| STAGE290LU3 | 98 | TIE2020 | 119 | WS6BK | 21 |
| STAGE290LU5 | 98 | TIE2030 | 119 | WS6MBK | 21 |
| STAGE295LU1 | 98 | TN0804 | 189 | X | |
| STAGE295LU10 | 98 | TN1204 | 189 | XLR3FDL | 179 |
| STAGE295LU2 | 98 | TN1204LU30 | 189 | XLR3FDLBK | 179 |
| STAGE295LU3 | 98 | TN1204LU50 | 189 | XLR3FDLX | 179 |
| STAGE295LU5 | 98 | TN12IN | 189 | XLR3FRX | 179 |
| STAGE330LU1 | 99 | TN1604 | 190 | XLR3FV | 177 |
| STAGE330LU10 | 99 | TN1604LU30 | 190 | XLR3FVBK | 177 |
| STAGE330LU2 | 99 | TN1604LU50 | 190 | XLR3FVPRO | 177 |
| STAGE330LU3 | 99 | TN1608 | 190 | XLR3FVPROBK | 177 |
| STAGE330LU5 | 99 | TN1608LU50 | 190 | XLR3FVPROBL | 177 |
| STAGE335LU05 | 99 | TN2408 | 190 | XLR3FVPRON | 177 |
| STAGE335LU1 | 99 | TN2408LU30 | 190 | XLR3FVPRORD | 177 |
| STAGE335LU10 | 99 | TN2408LU40 | 190 | XLR3MDL | 179 |
| STAGE335LU2 | 99 | TN2408LU50 | 190 | XLR3MDLBK | 179 |
| STAGE335LU3 | 99 | TN3208 | 190 | XLR3MDLX | 179 |
| STAGE335LU5 | 99 | TN3208LU50 | 190 | XLR3MRX | 179 |
| STAGE340LU05 | 99 | TN8IN | 189 | XLR3MV | 178 |
| STAGE340LU1 | 99 | TN8INLU20 | 189 | XLR3MVBK | 178 |

ALPHABETICAL INDEX

| CODE | PAGE |
|--------------------|------|
| XLR3MVPRO | 178 |
| XLR3MVPROBK | 178 |
| XLR3MVPROBL | 178 |
| XLR3MVPRON | 178 |
| XLR3MVPRORD | 178 |
| XLR5FDL | 179 |
| XLR5FV | 177 |
| XLR5FVPRO | 177 |
| XLR5FVPRON | 177 |
| XLR5MDL | 179 |
| XLR5MV | 178 |
| XLR5MVPRO | 178 |
| XLR5MVPRON | 178 |

• Tutte le specifiche possono essere variate senza alcuna notifica
• Design and specifications subject to change without any notice

• É vietata la riproduzione fotostatica e fotografica del presente catalogo, o di parti di esso, in mancanza di espressa autorizzazione da parte di Proel S.p.A.
• The photostatic and photographic reproduction of this catalogue, in whole or in part, is strictly prohibited without the prior written consent of Proel S.p.A

NOTE



PROEL BRAND'S



Professional Audio



Professional Lighting

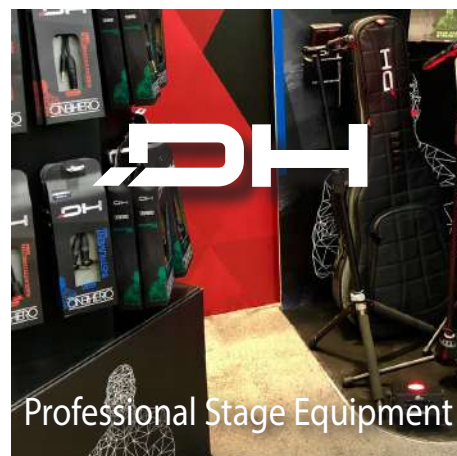

Professional Stage Equipment



Microphones & Headphones

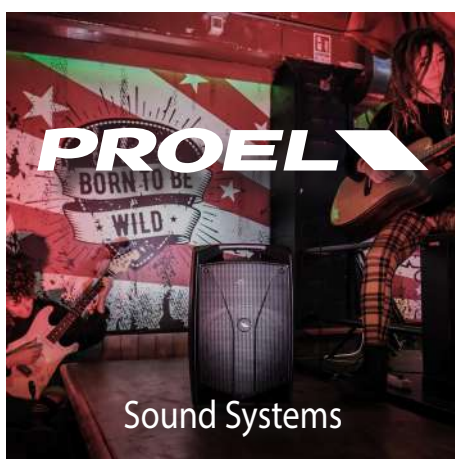

Sound Systems



Digital Pianos



String Instruments



Wind Instruments

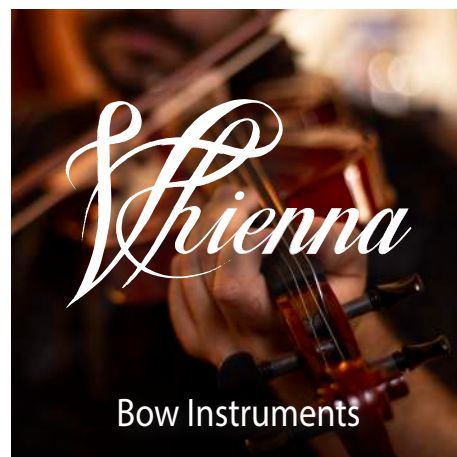

Bow Instruments



Drums



Commercial Audio and Evacuation Systems

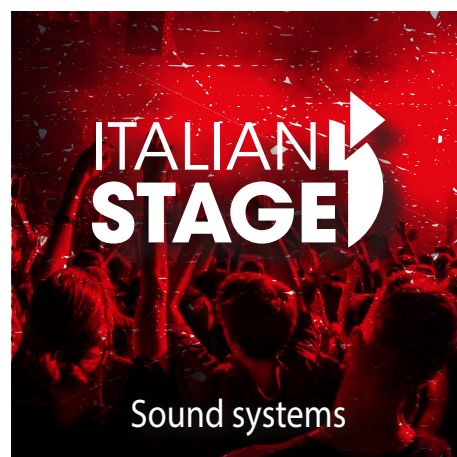

Sound systems



STEQCAT21IE

www.proel.com

PROEL 

UK

Proel International Ltd.
London

KOREA

Proel Korea Co. Ltd.
Gyunggi-Do

USA

Proel North America Inc.
Los Angeles

TUNISIE

Proel Tunisia Sarl
Tunisi

PROEL SPA

(Worldwide Headquarters)
Via alla Ruenia, 37/43
64027 Sant'Omero (TE) - ITALY
Tel. +39 0861 81241
Fax +39 0861 887862
P.I. 00778590679
N.Reg.AEE IT 08020000002762

info@proel.com
www.proel.com

